

ABPOPA

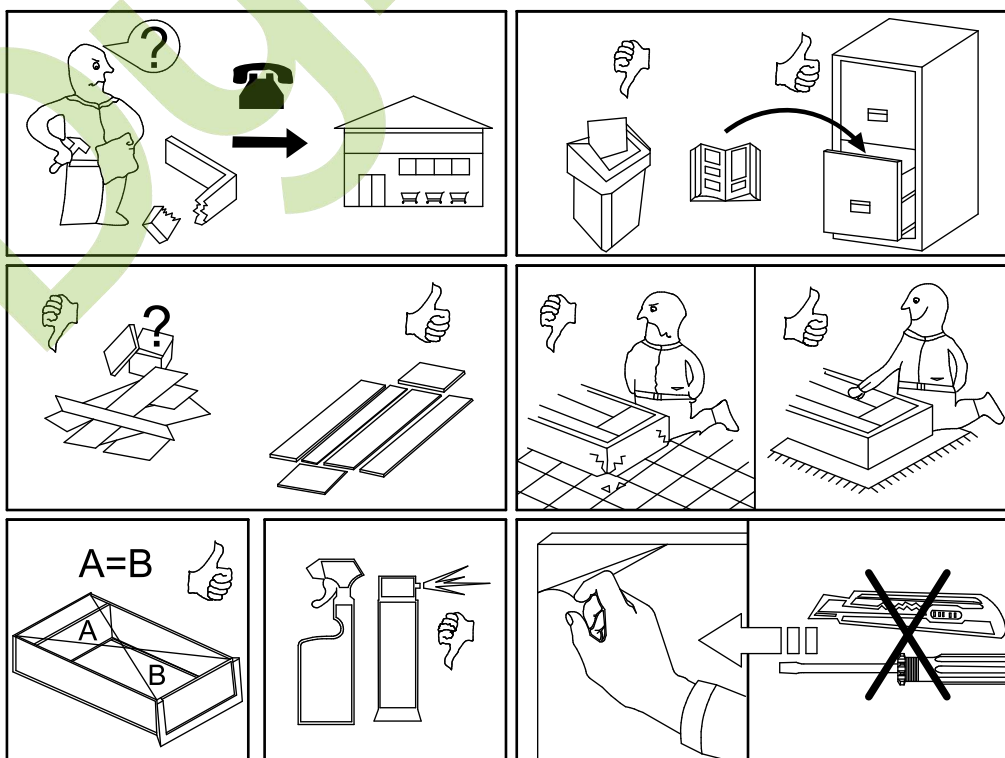

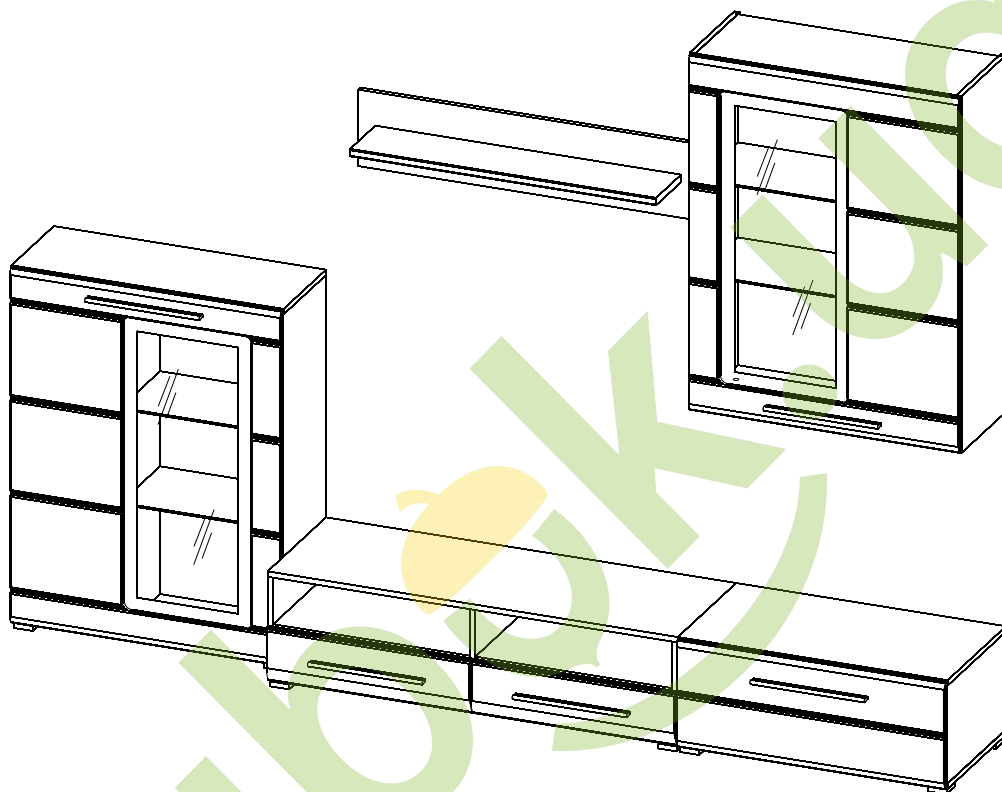

2x K16 a1	6x K0 a2	8x b1	5x L 340 mm c520	16x $\phi 5 \times 17$ mm d3	20x $\phi 7 \times 50$ mm e1
8x $\phi 6 \times 13$ mm e3	4x $\phi 5 \times 11$ mm e4	8x $\phi 5 \times 50$ mm e32	56x $\phi 8 \times 35$ mm f29	2x g2	4x M4x9 mm j2
14x 56x56/20 mm k52	115x l1	10x l2	16x 3 mm l3	1x m48	2x n2
2x 50x12/1,5 mm n3	2x n10	1x 81x21x15/1,5mm n14	12x 20x13x3,5/1mm n108	2x n122/1	4x silikon $\phi 8 \times 1,8$ mm o21
4x o43/1	1x o43/6	4x $\phi 3,5 \times 13$ mm p1	6x $\phi 3,5 \times 13$ mm p5	15x $\phi 4 \times 30$ mm p9	
32x $\phi 4 \times 30$ mm p21	12x $\phi 2,9 \times 16$ mm p55	16x $\phi 3 \times 16$ mm p52	4x $\phi 3 \times 10$ mm p400	52x $\phi 15 \times 12$ mm #16 r1	4x $\phi 12 \times 10,5$ mm #12 r15
56x 30/11 r23	44x $\phi 16$ s2	2x $\phi 5$ s4	4x 310 mm w4	1x GLUE y1	1x z1

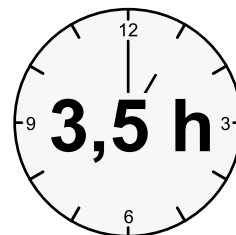
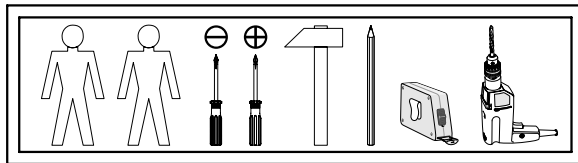
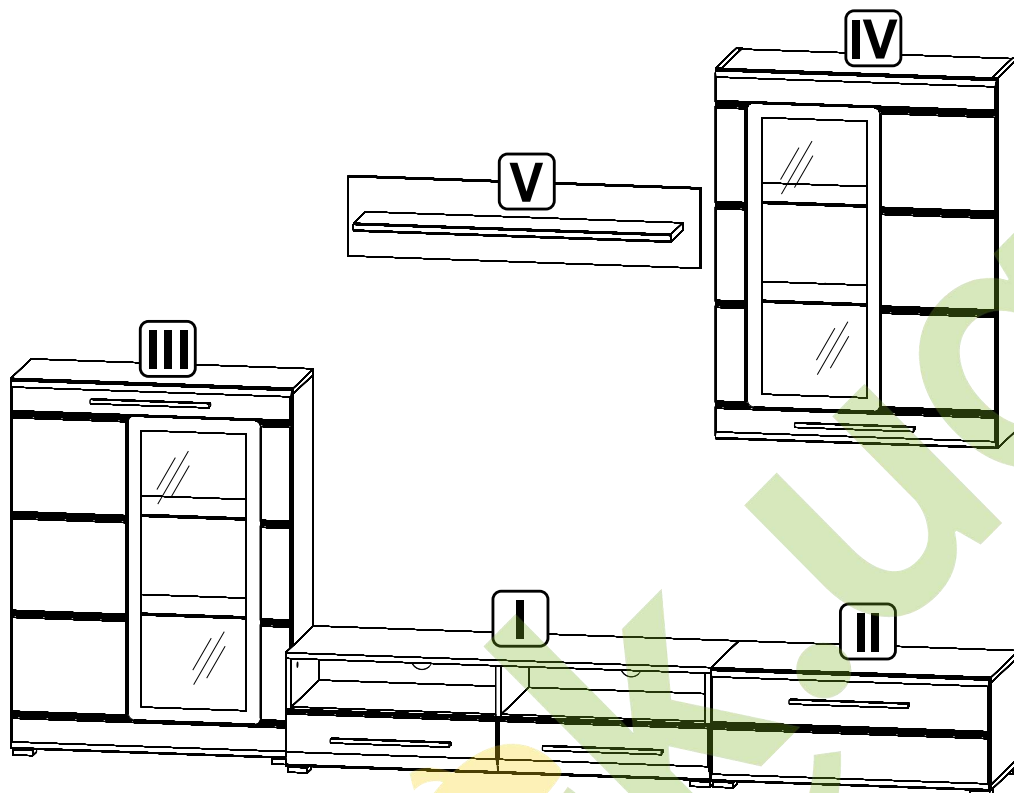
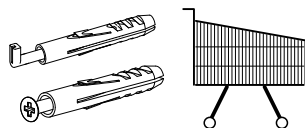

I Тумба РТВ

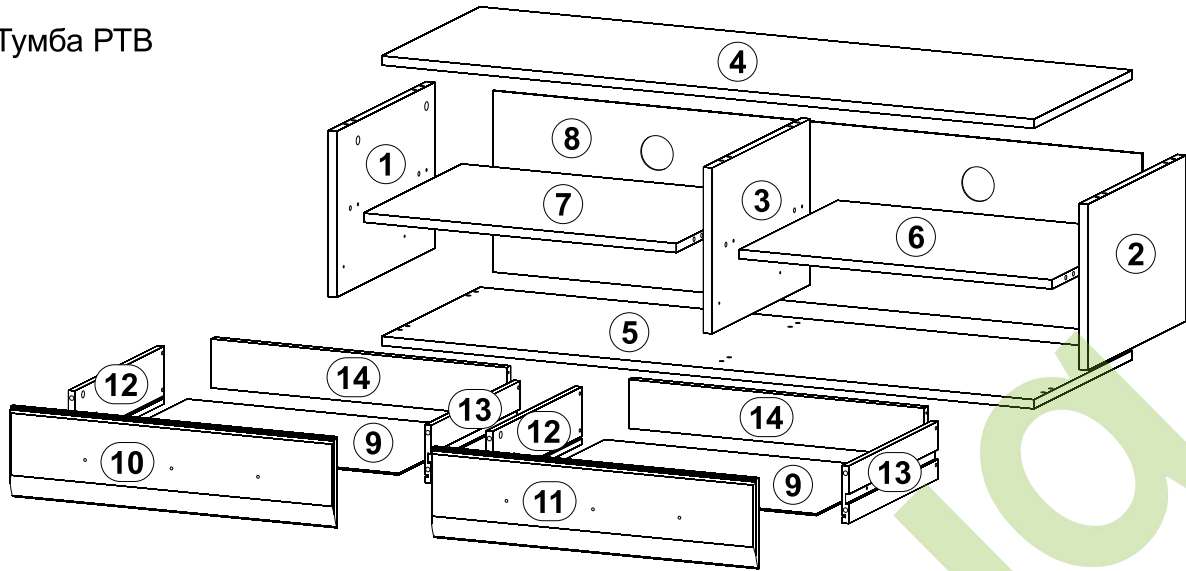

A	B	C	D	A	B	C	D	
1	PU1-104	288	413	1/4	8	PU1-911	1202 315	1/4
2	PU1-103	288	413	1/4	9	PU1-904	558 378	1/4
3	PU1-122	288	413	1/4	10	PU1-021A	600 158	4/4
4	PU1-207	1207	413	1/4	11	PU1-022A	600 158	4/4
5	PU1-208	1207	413	1/4	12	PU1-551	375 100	4/4
6	PU1-307	579	413	1/4	13	PU1-552	375 100	4/4
7	PU1-308	579	413	1/4	14	PU1-558	547 85	2/4



1

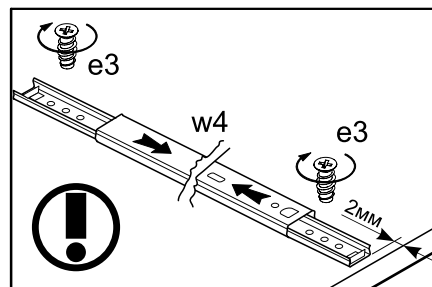
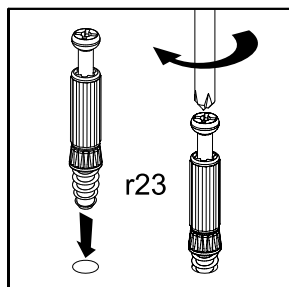
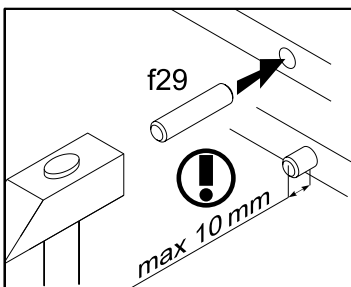
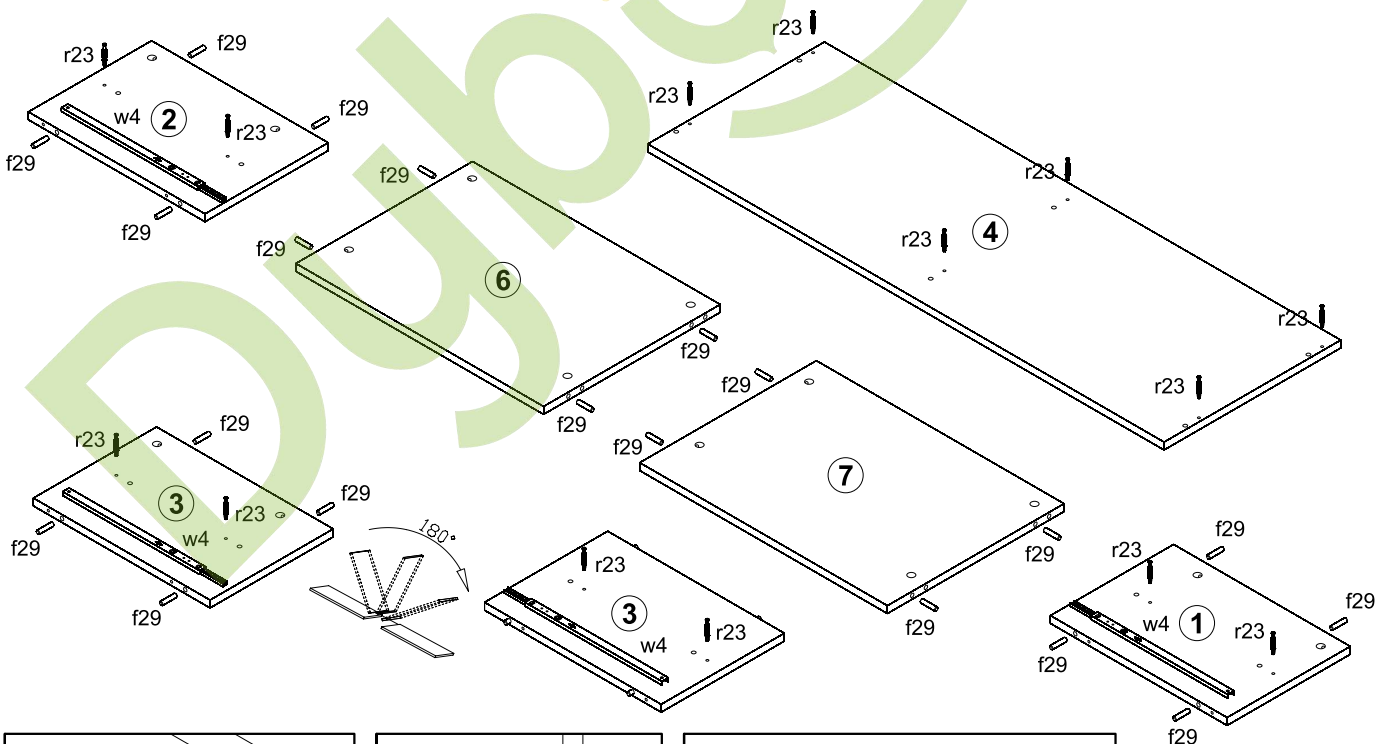
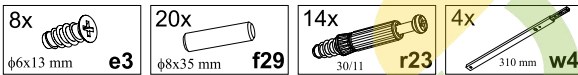

2



8x $\phi 15 \times 12 \text{mm}$ #16 r1

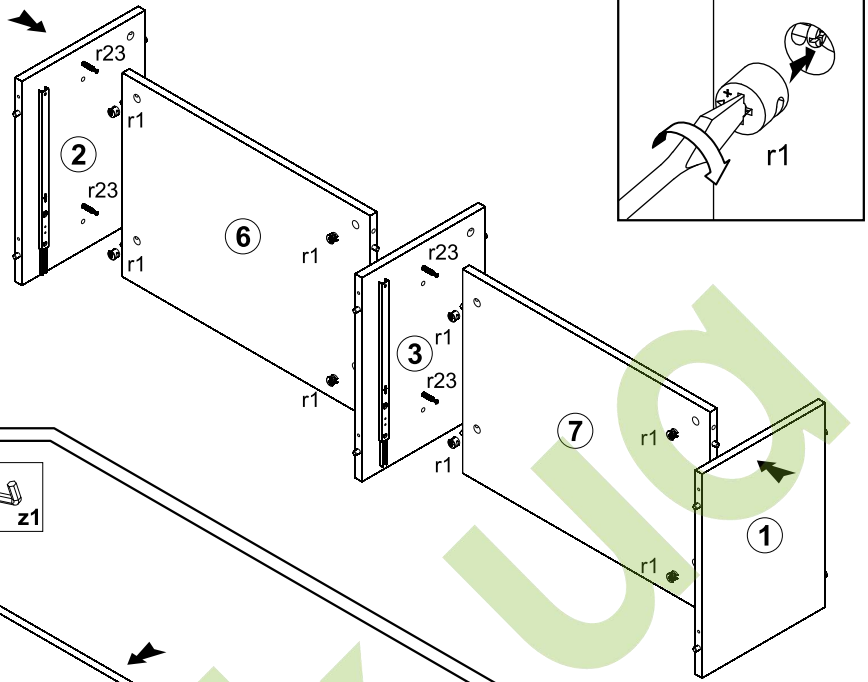

3

6x $\phi 7 \times 50 \text{mm}$ e1

6x $\phi 15 \times 12 \text{mm}$ #16 r1

1x z1

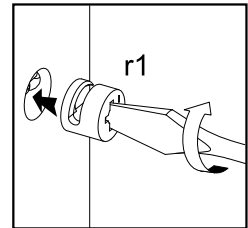
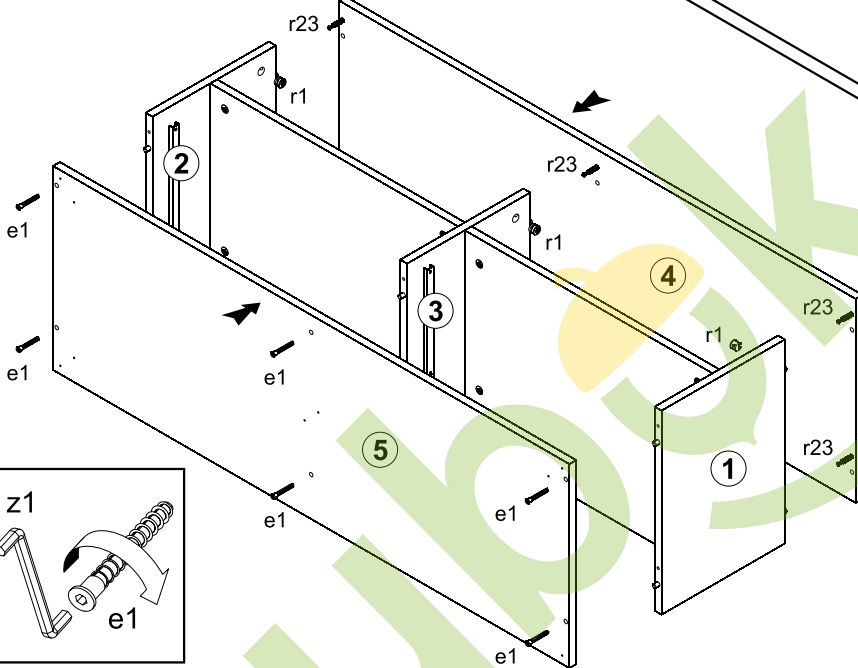

4

36x l1

5x $56 \times 56 \times 20 \text{mm}$ k52

10x $\phi 4 \times 30 \text{mm}$ p21

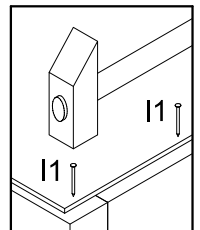
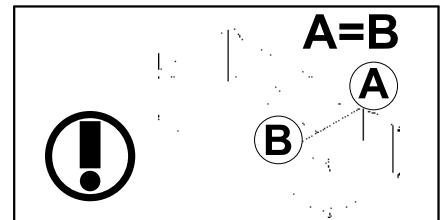
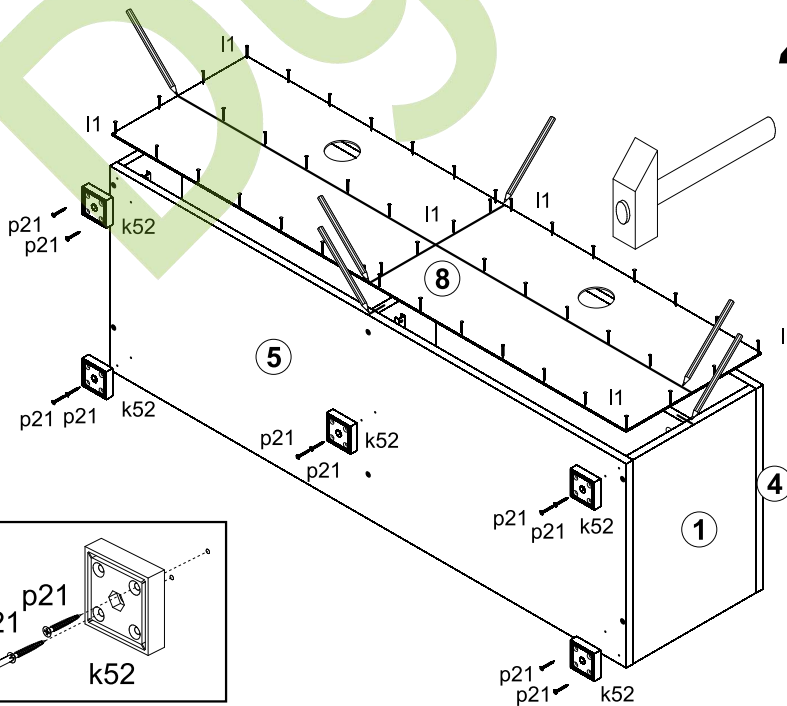

5

8x $\phi 5 \times 50$ mm e32

4x $\phi 8 \times 35$ mm f29

12x I1

4x I2

4x $\phi 12 \times 10,5$ mm #12 r15

4x 30/11 r23

1x GLUB y1

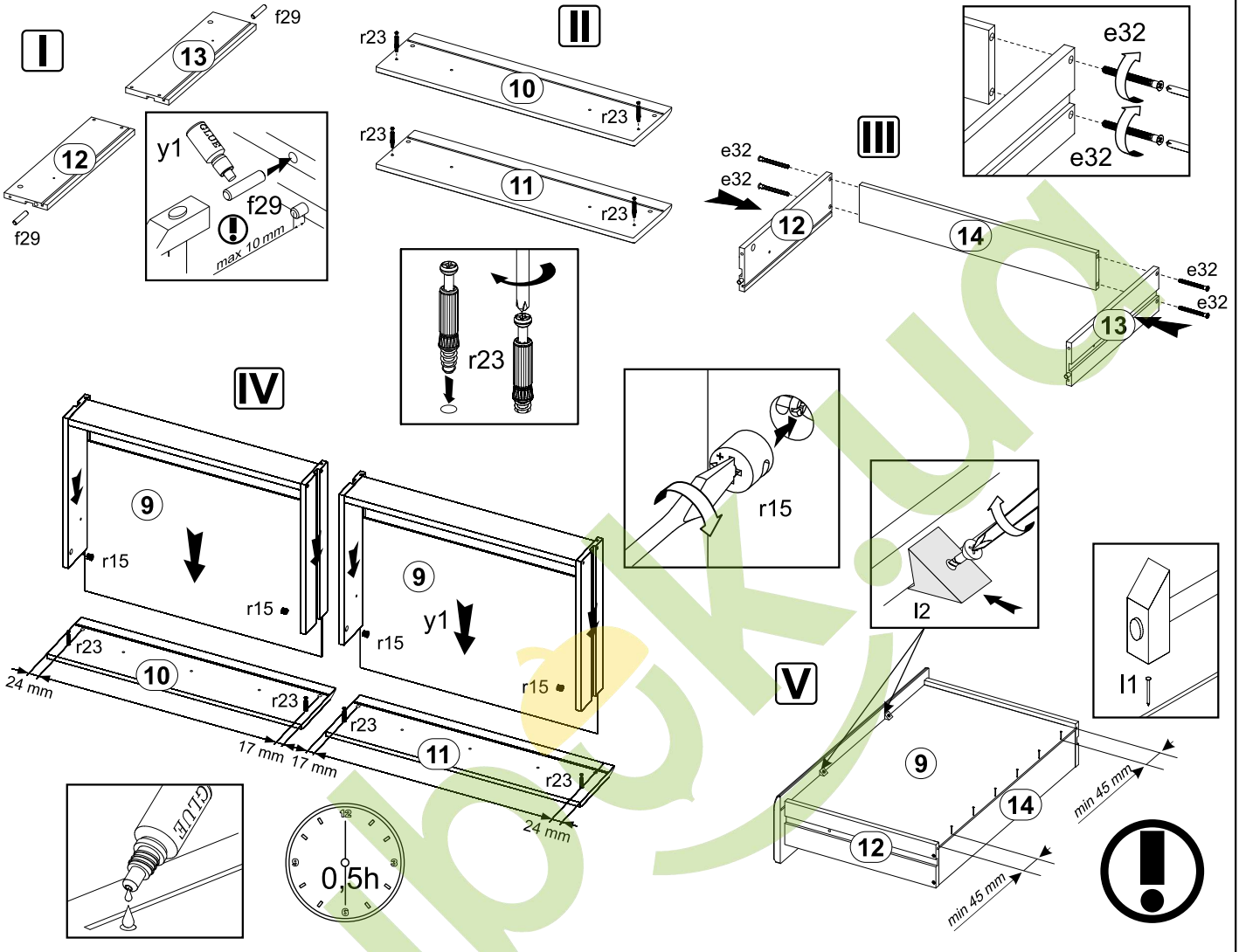

6

2x L 340 mm c520

4x M4x9 mm j2

6x $\phi 4 \times 30$ mm p9

6x $\phi 16$ s2

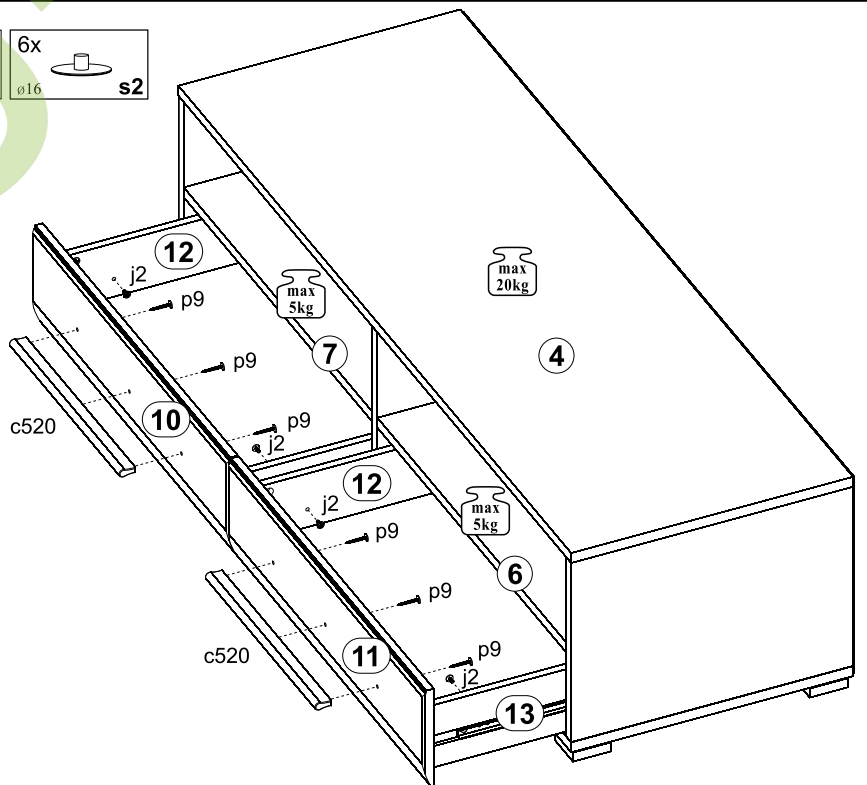
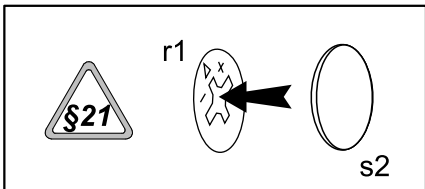
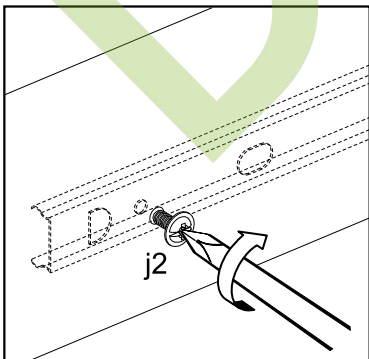



Тумба 1D

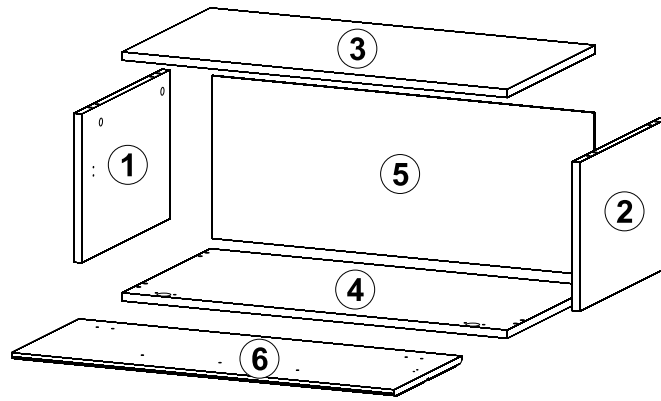

A	B	C	D	
1	PU1-101	288	413	1/4
2	PU1-106	288	413	1/4
3	PU1-209	796	413	1/4
4	PU1-210	796	413	1/4
5	PU1-916	790	315	1/4
6	PU1-020A	792	316	4/4



7

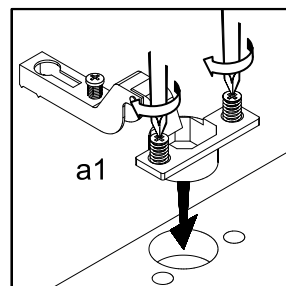
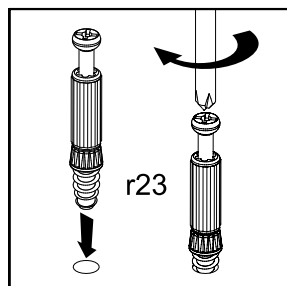
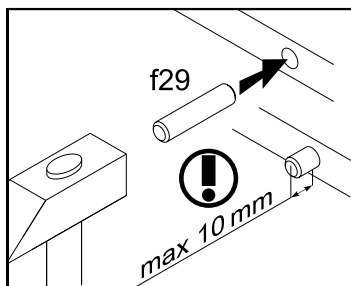
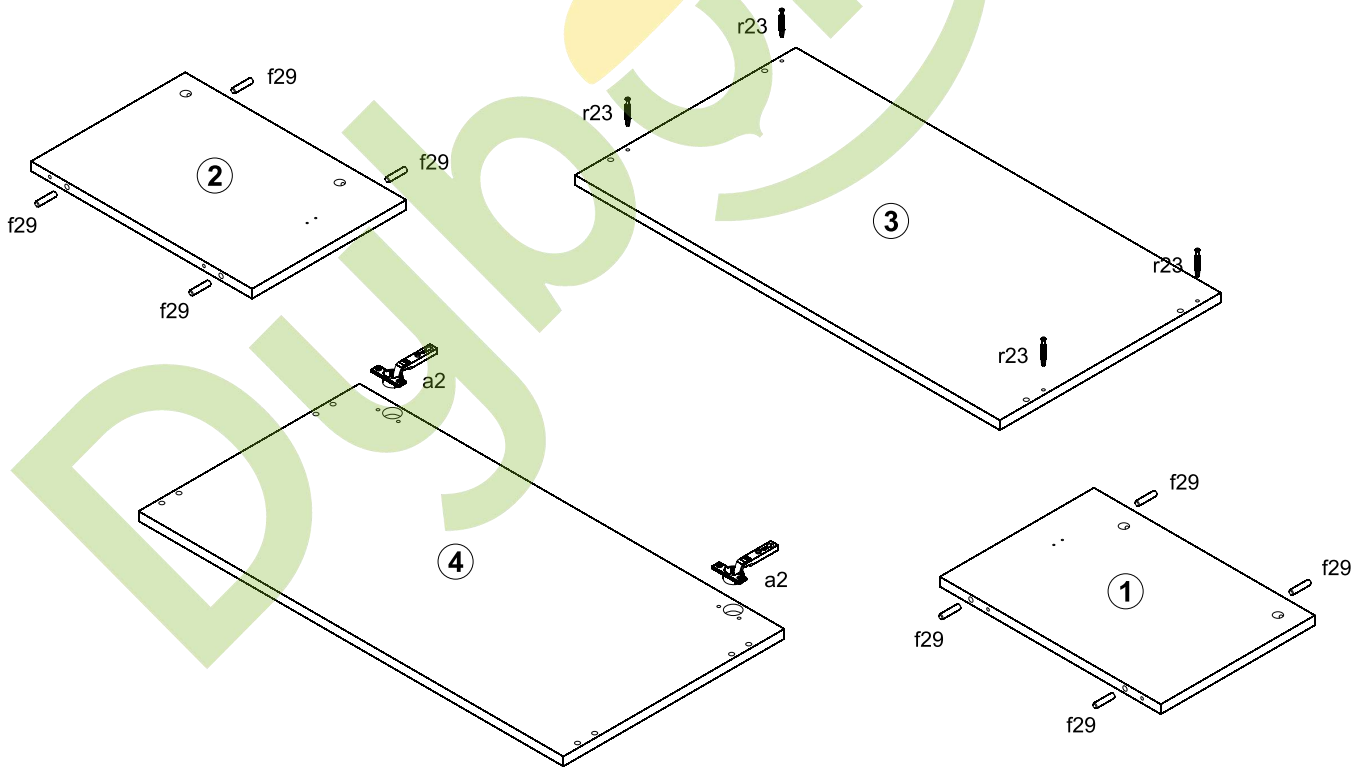
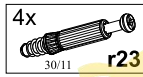
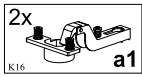

8

- 4x $\phi 7 \times 50$ mm e1
- 4x $\phi 15 \times 12$ mm #16 r1
- 1x z1

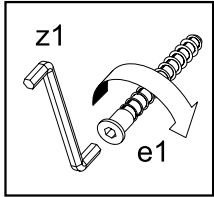
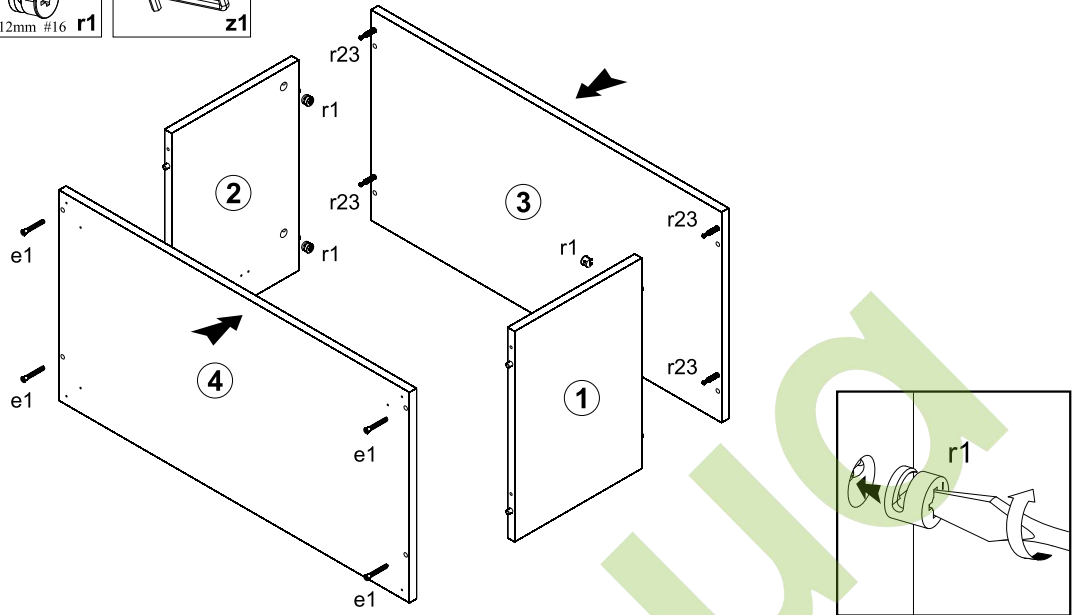

9

- 36x l1
- 4x 56x56x20 mm k52
- 8x $\phi 4 \times 30$ mm p21

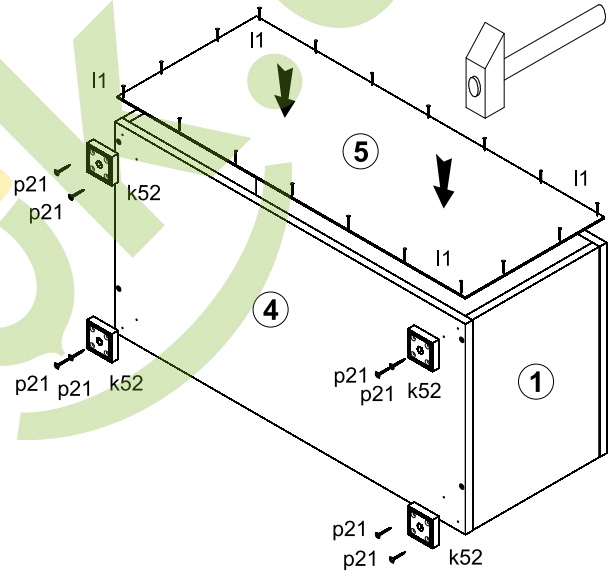
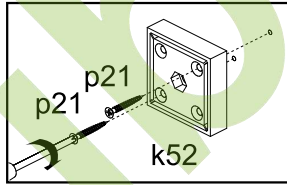
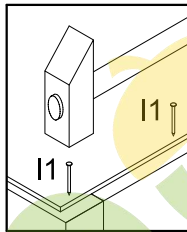
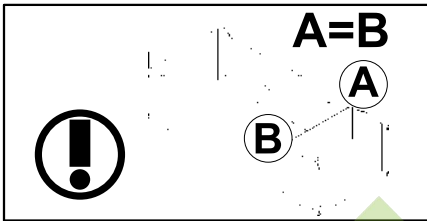

10

- 1x L 340 mm c520
- 1x m48
- 4x $\phi 3.5 \times 13$ mm p1
- 3x $\phi 4 \times 30$ mm p9
- 4x $\phi 16$ s2

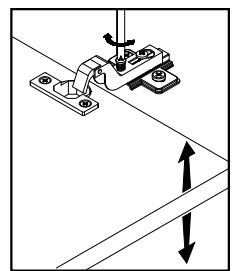
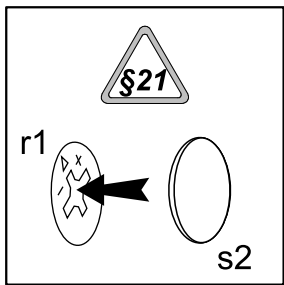
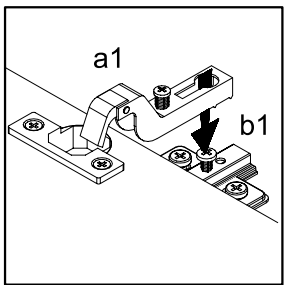
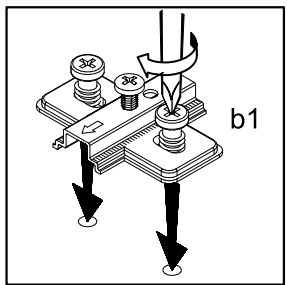
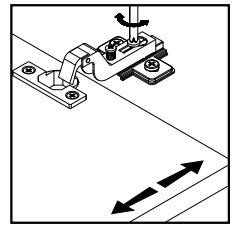
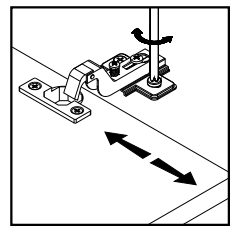
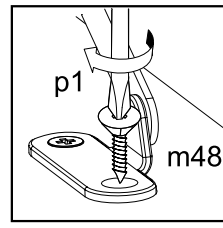
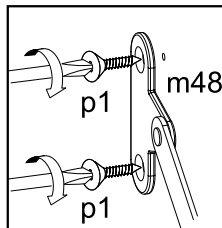
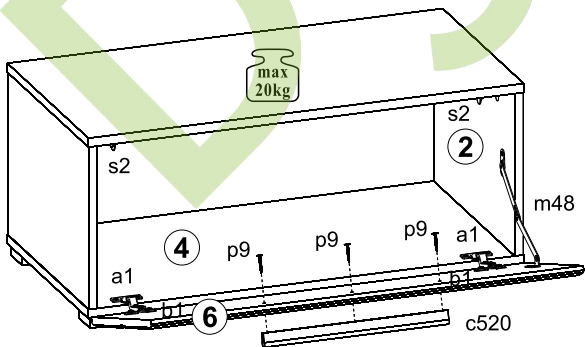



Вітрина ліва / Витрина левая

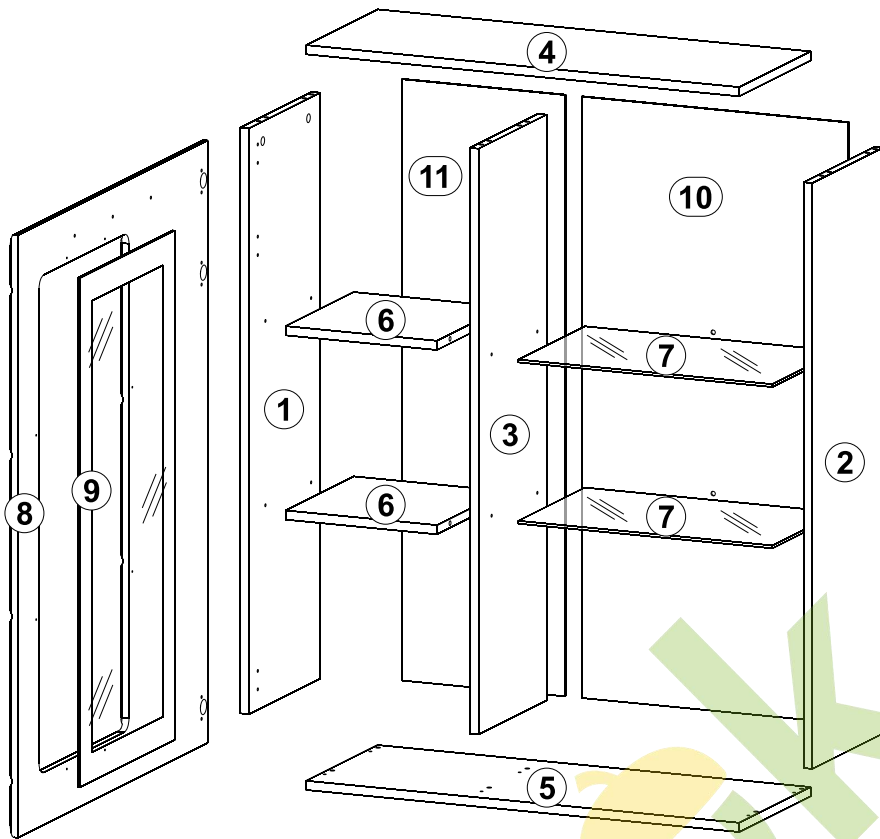

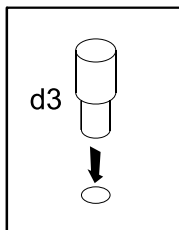
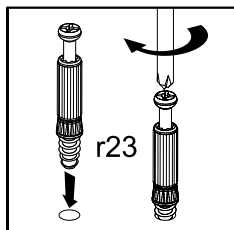
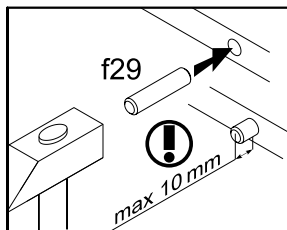
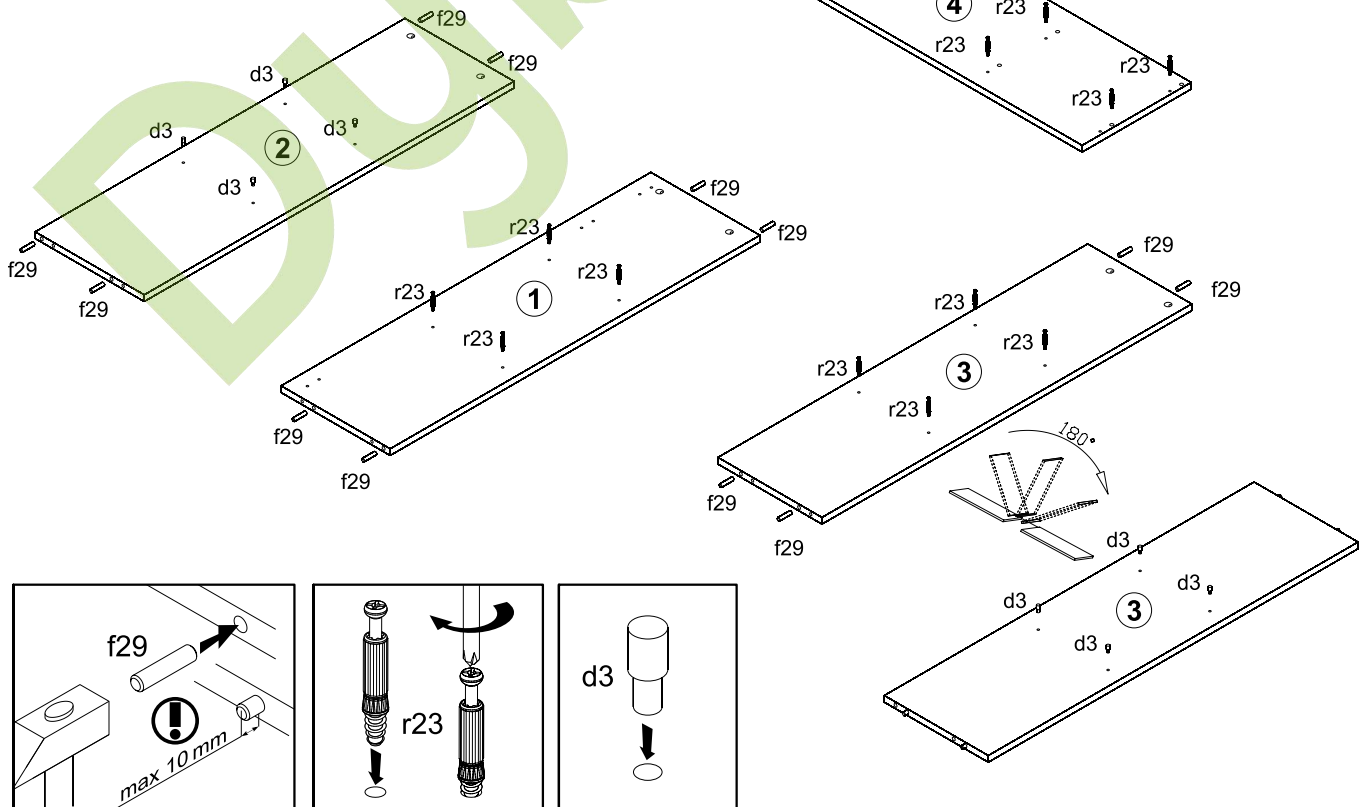
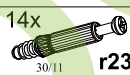
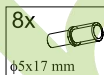
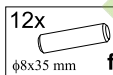

A	B	C	D	
1	PU1-110	1017	330	2/4
2	PU1-111	1017	330	2/4
3	PU1-121	1017	316	2/4
4	PU1-205	800	330	2/4
5	PU1-206	800	330	2/4
6	PU1-313	280	316	2/4
7	PU1-312	469	309	2/4
8	PU1-009A	1046	796	4/4
9	PU1-501	884	398	4/4
10	PU1-908	1044	492	4/4
11	PU1-909	1044	301	4/4

11

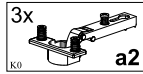
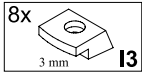
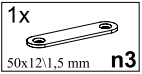
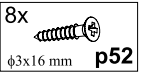

12

- 3x  a2
- 8x  l3 3 mm
- 1x  n3 50x12,1,5 mm
- 8x  p52 $\phi 3 \times 16$ mm
- 2x  p400 $\phi 3 \times 10$ mm

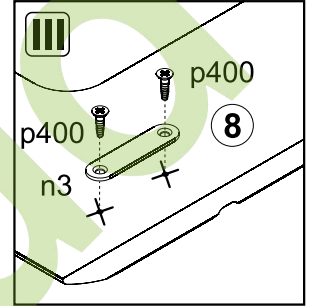
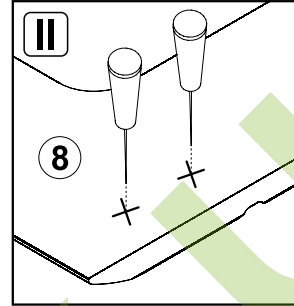
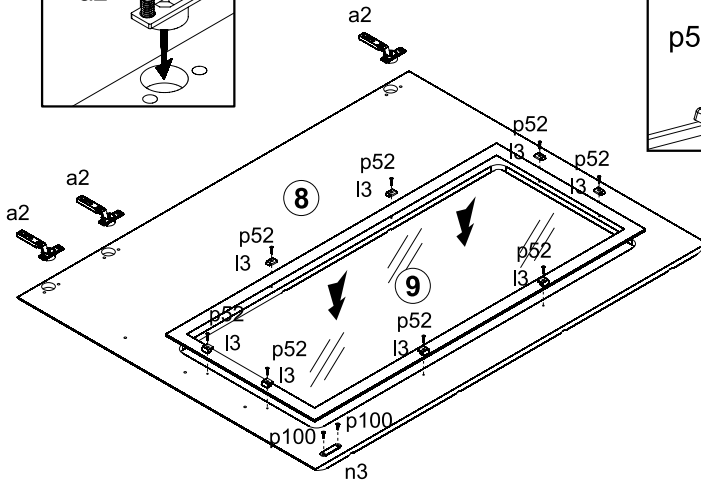
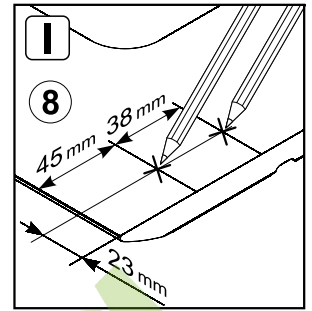
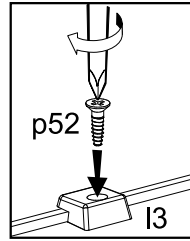
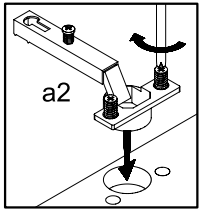

13

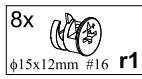

- 8x  r1 $\phi 15 \times 12$ mm #16

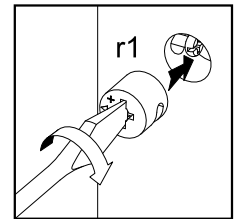
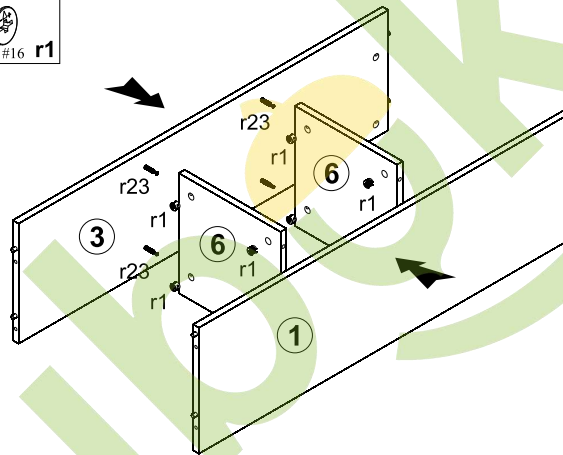

14

- 6x  e1 $\phi 7 \times 50$ mm
- 6x  r1 $\phi 15 \times 12$ mm #16
- 1x  z1

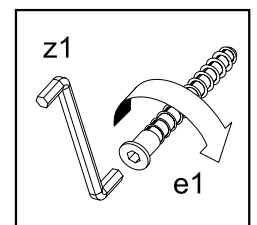
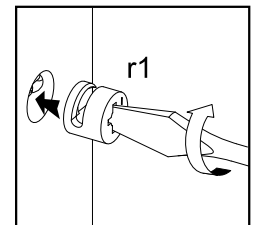
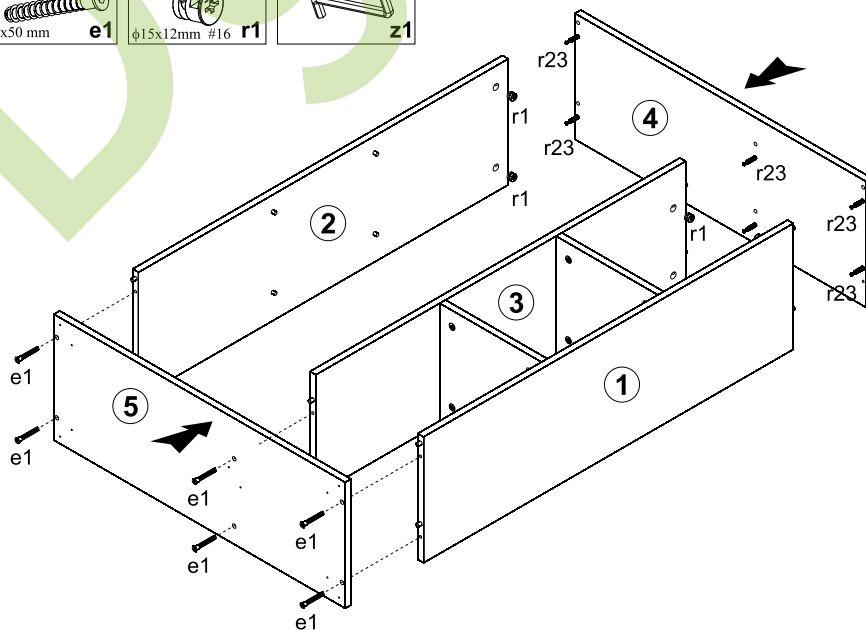

15

- 24x **l1**
- 5x **k52** 56x56x20 mm
- 6x **n108** 20x13x3,5/1mm
- 6x **p55** $\phi 2,9 \times 16$ mm
- 10x **p21** $\phi 4 \times 30$ mm

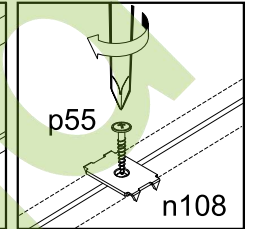
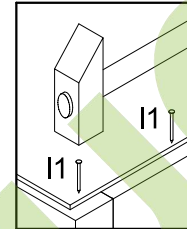
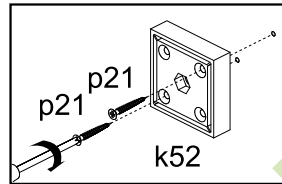
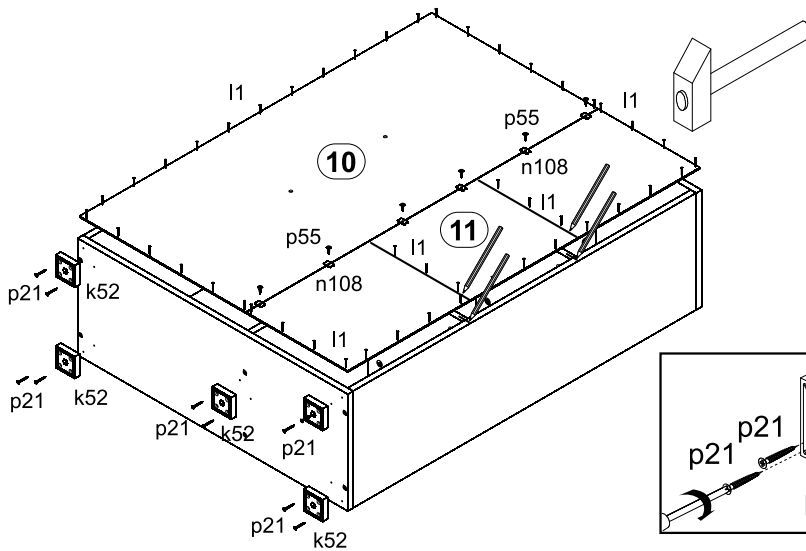
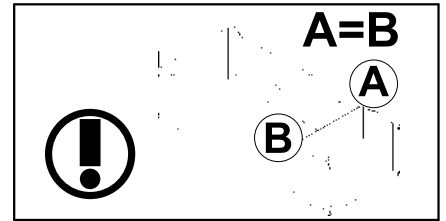

16

- 1x **n14** 81x21x15/1,5mm
- 2x **p5** $\phi 3,5 \times 13$ mm

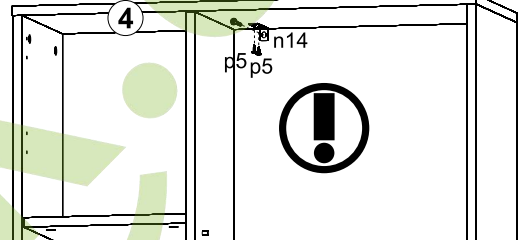
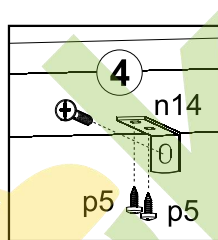
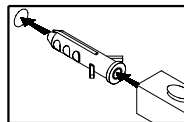
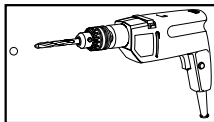

17

- 3x **b1**
- 1x **c520** L 340 mm
- 1x **n2**
- 2x **o21** $\phi 8 \times 1,8$ mm silikon
- 2x **o43/1**
- 2x **p5** $\phi 3,5 \times 13$ mm
- 3x **p9** $\phi 4 \times 30$ mm
- 14x **s2** $\phi 16$

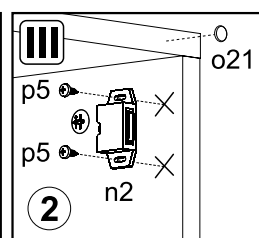
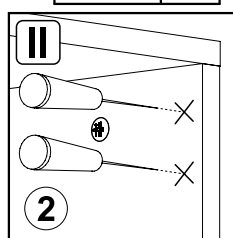
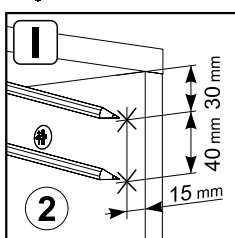
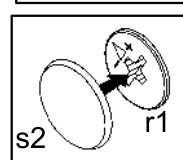
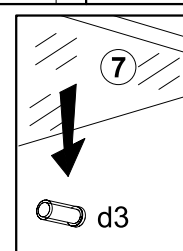
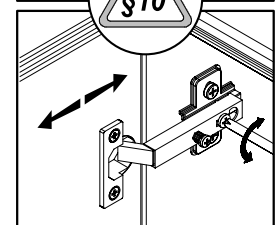
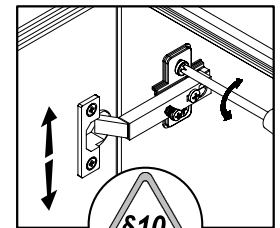
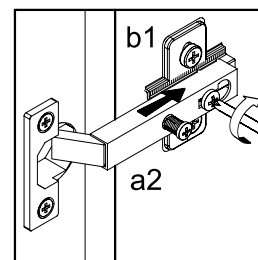
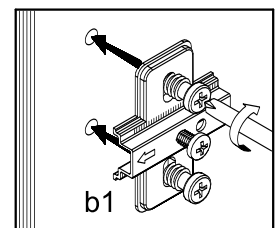
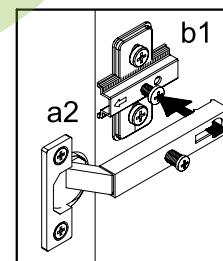
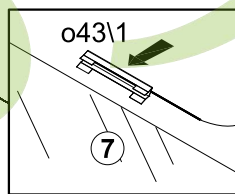
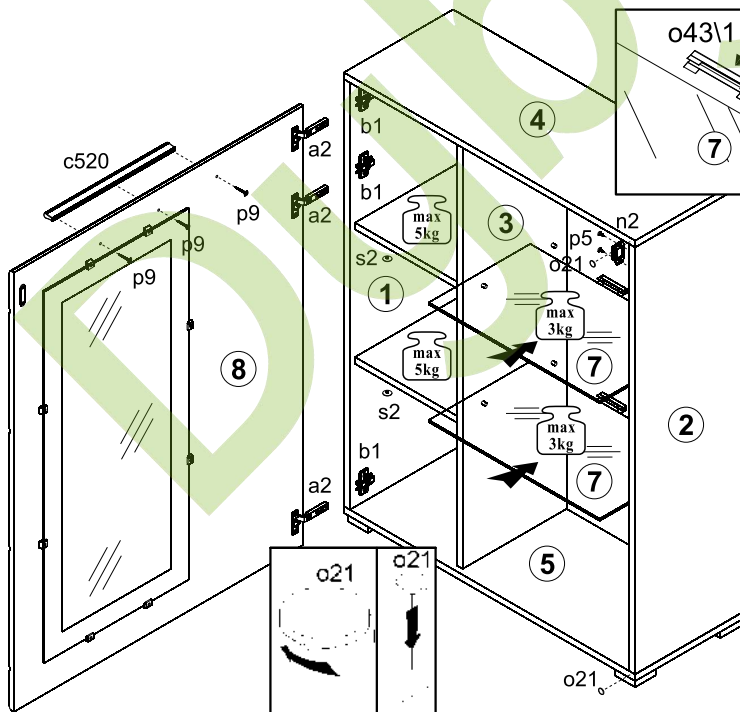

IV

Вітрина навесна права / Витрина навесная правая

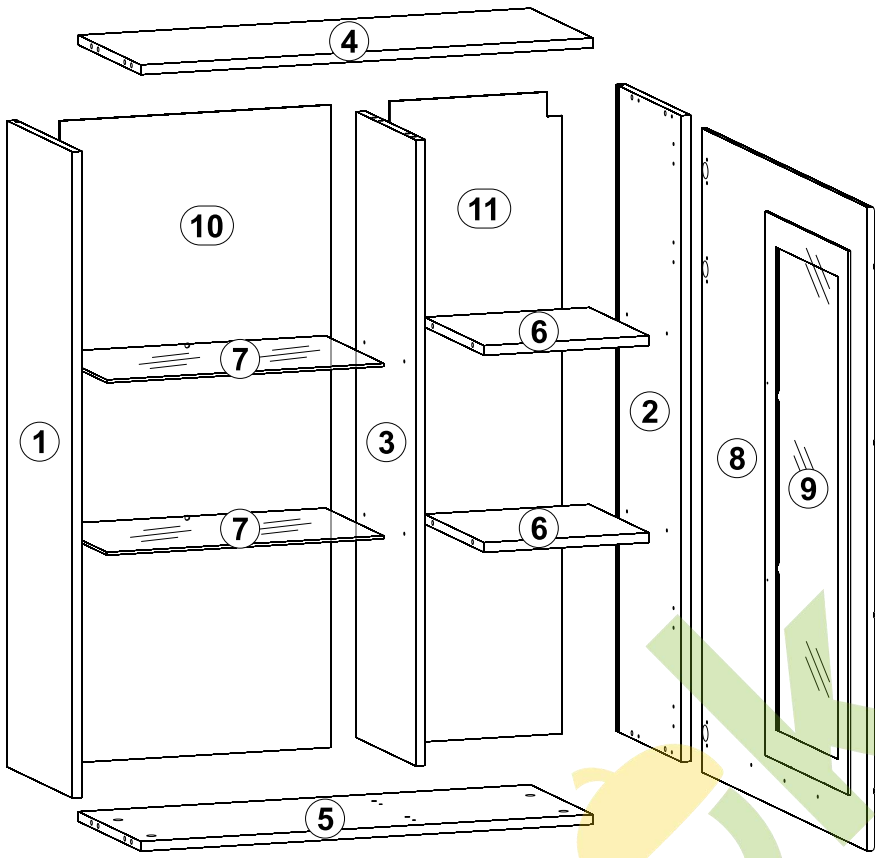

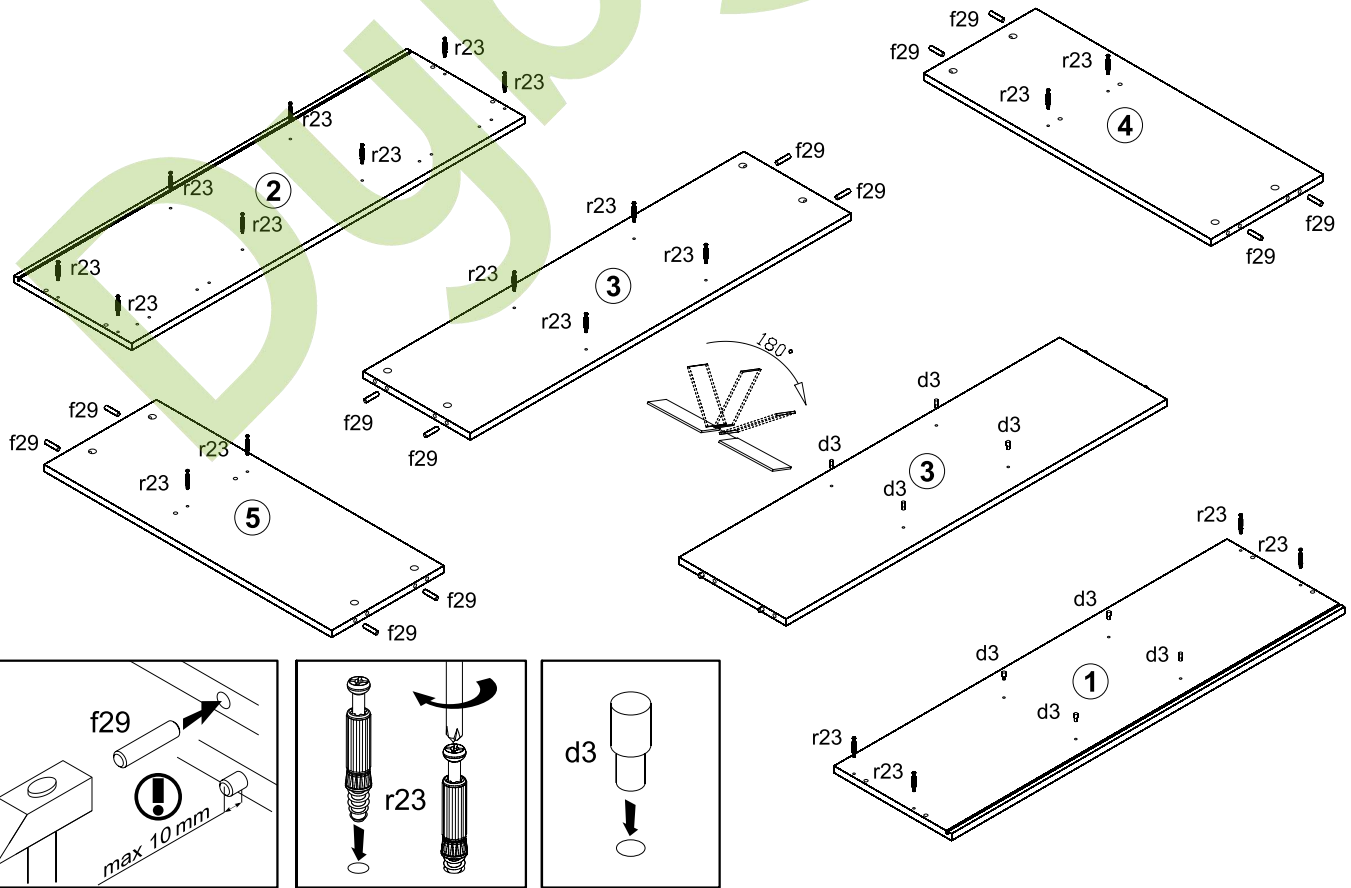

A	B	C	D	
1	PU1-108-01	1050	314	3/4
2	PU1-107-01	1050	314	3/4
3	PU1-109	1017	286	3/4
4	PU1-302	768	300	3/4
5	PU1-303	768	300	3/4
6	PU1-304	280	286	3/4
7	PU1-305	470	279	3/4
8	PU1-007A	1046	796	4/4
9	PU1-501	884	398	4/4
10	PU1-905	1044	485	4/4
11	PU1-906	1044	293	4/4

18

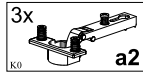
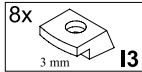
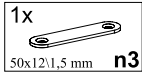
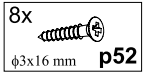

19

- 3x  a2
- 8x  l3
3 mm
- 1x  n3
50x12,1,5 mm
- 8x  p52
φ3x16 mm
- 2x  p400
φ3x10 mm

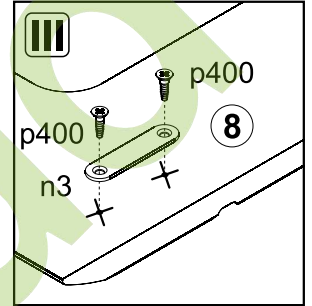
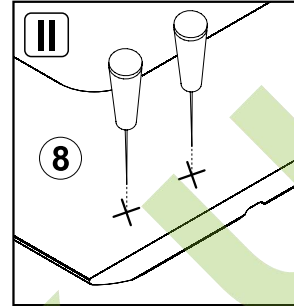
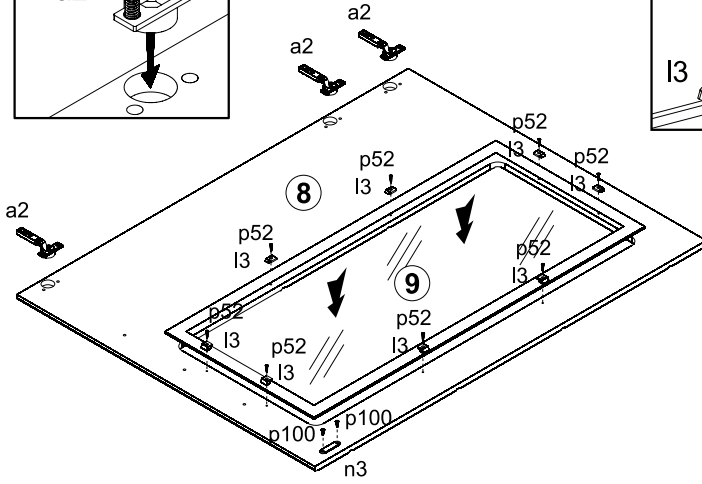
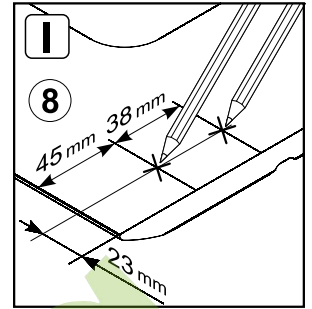
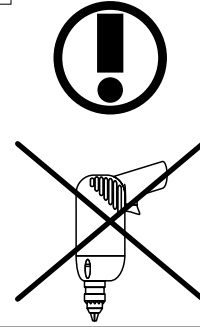
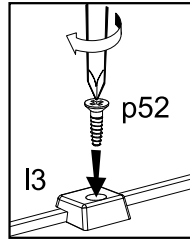
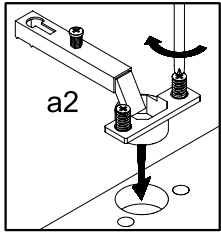

20

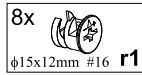

- 8x  r1
φ15x12mm #16

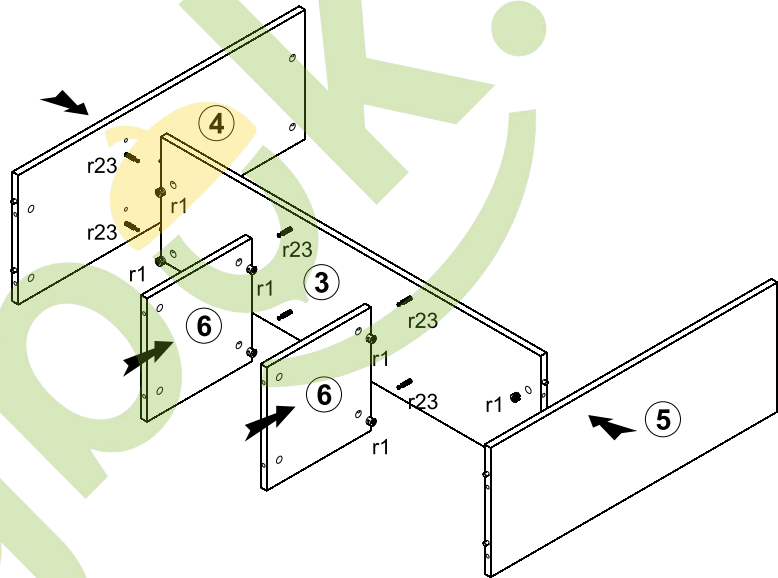
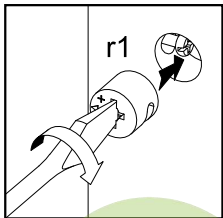

21

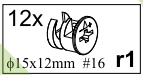
- 12x  r1
φ15x12mm #16

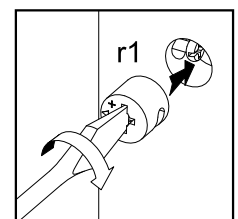
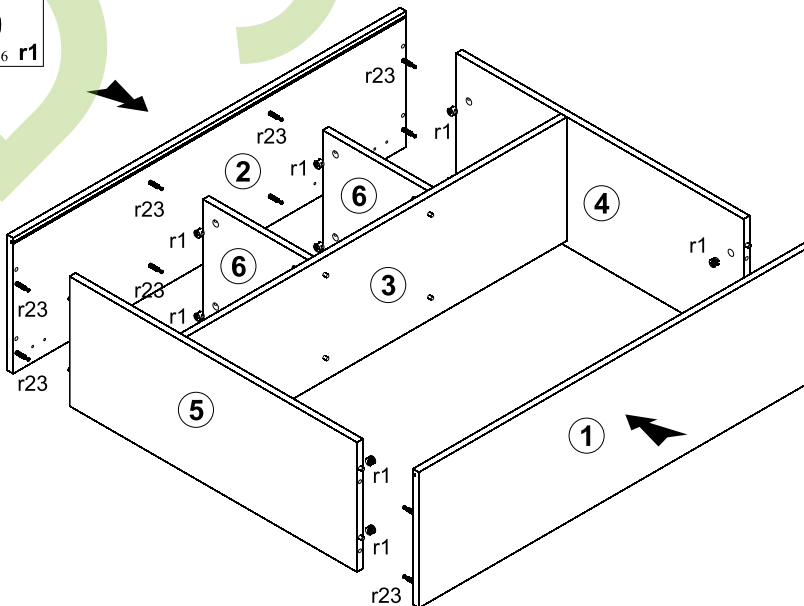

22

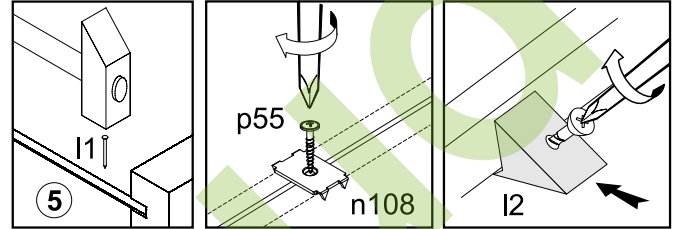
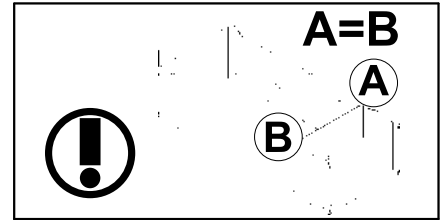
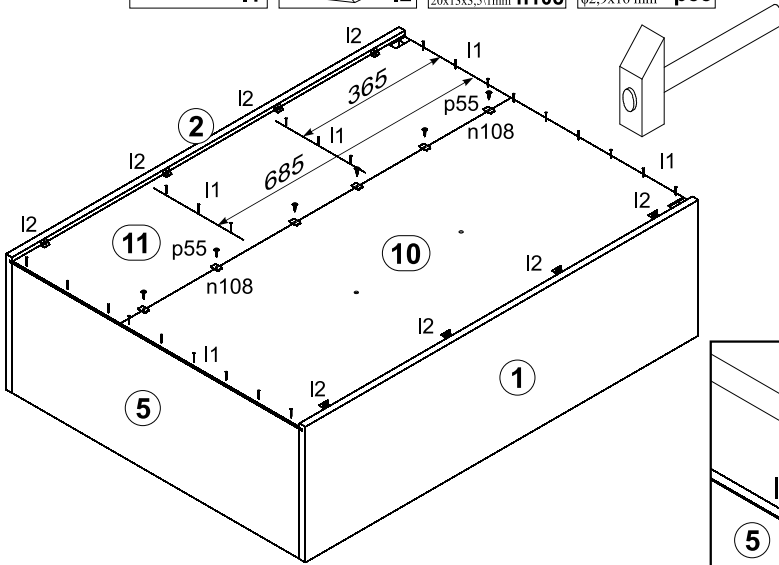

23

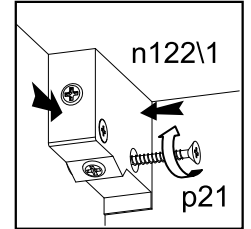
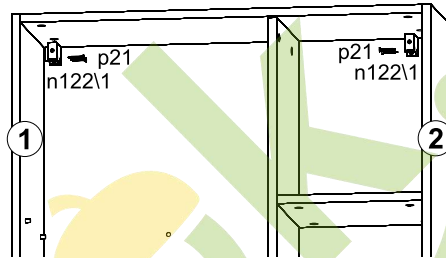
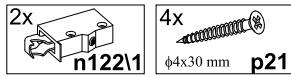

24

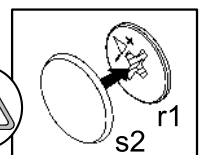
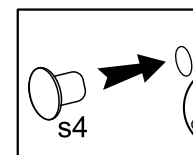
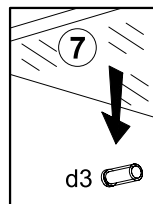
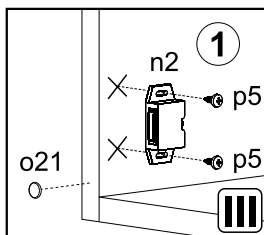
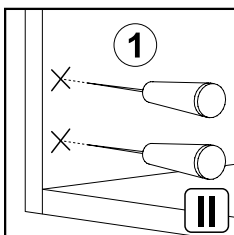
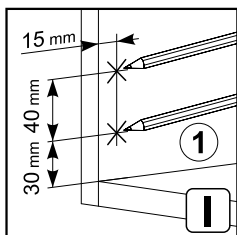
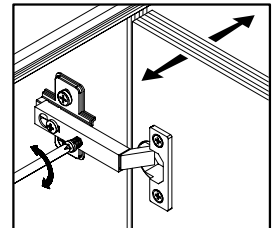
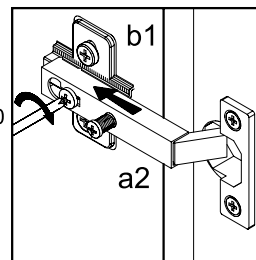
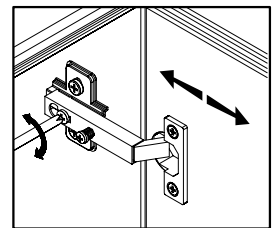
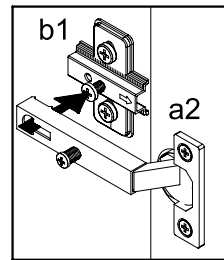
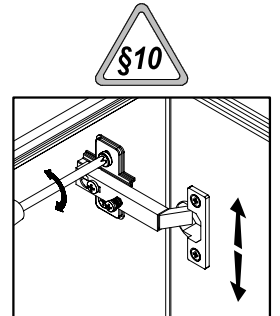
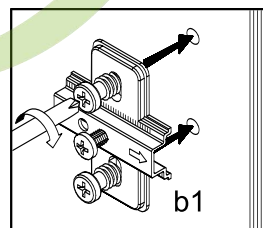
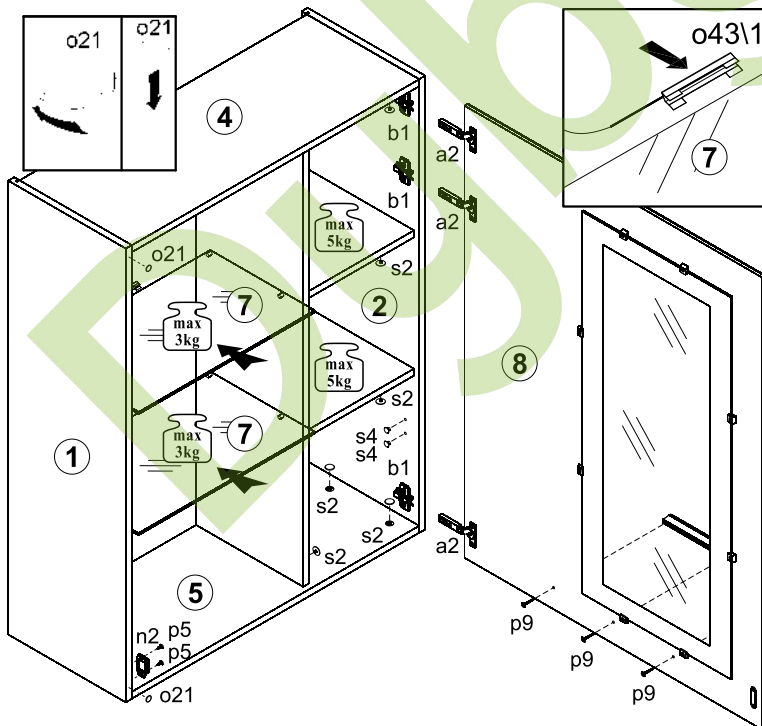

V Полиця / Полка

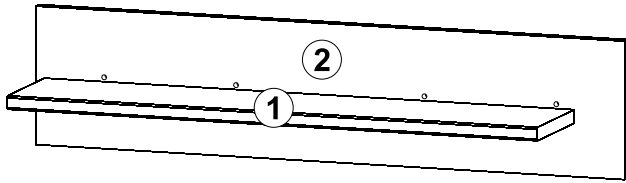

A	B	C		D
1	PU1-306	900	180	4/4
2	PU1-401	225	1000	4/4



25

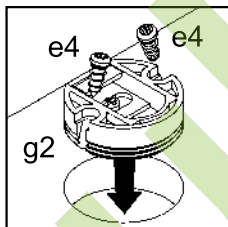
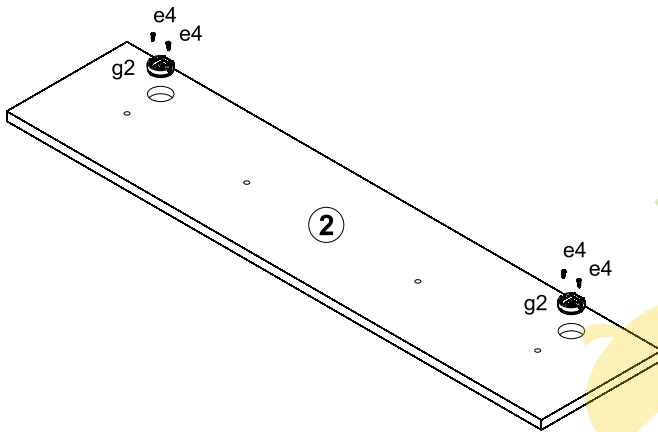
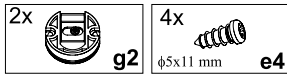

26

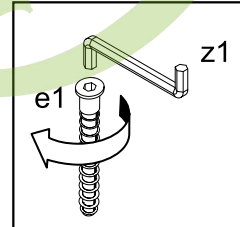
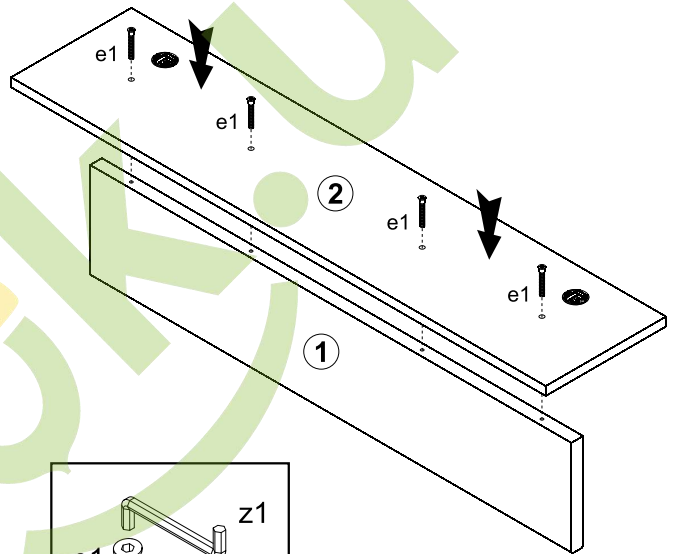

27

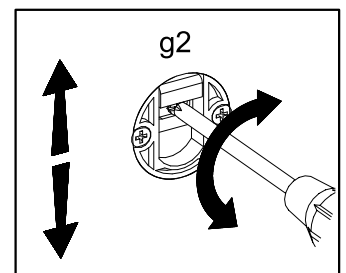
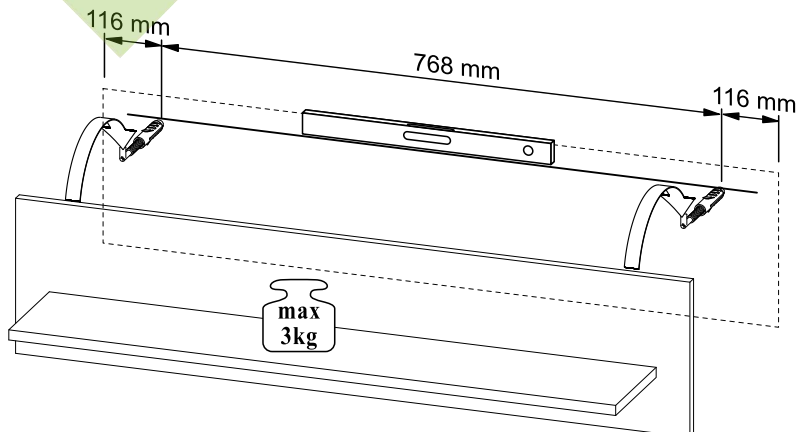
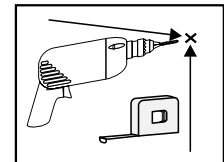
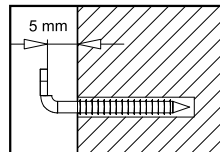
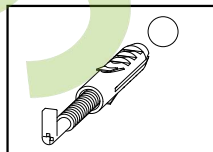

28

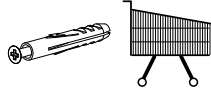
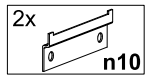

25 mm 64 mm 64 mm 25 mm

