

Installation manual

DINA KOM 2D4S

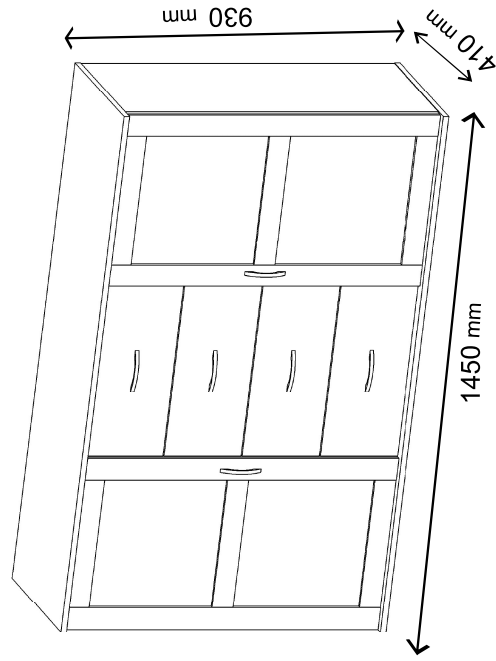

Element symbol	Dimensions	Code	Package
1	1450 410 16	D - 205	1/3
2	1450 410 16	D - 206	1/3
3	898 366 16	D - 106	1/3
4	898 366 16	D - 107	1/3
5	898 370 16	D - 104	1/3
6	898 370 16	D - 105	1/3
7	894 481 16	D - 003	2/3
8	894 481 16	D - 003	2/3
9	459 365 16	D - 304	1/3
10	409 150 16	D - 505	1/3
11	350 150 16	D - 506	1/3
12	409 150 16	D - 507	1/3
13	350 150 16	D - 508	1/3
14	221 479 16	D - 004	2/3
15	916 482 3	D - 604	2/3
16	916 476 3	D - 605	2/3
17	423 332 3	D - 606	2/3

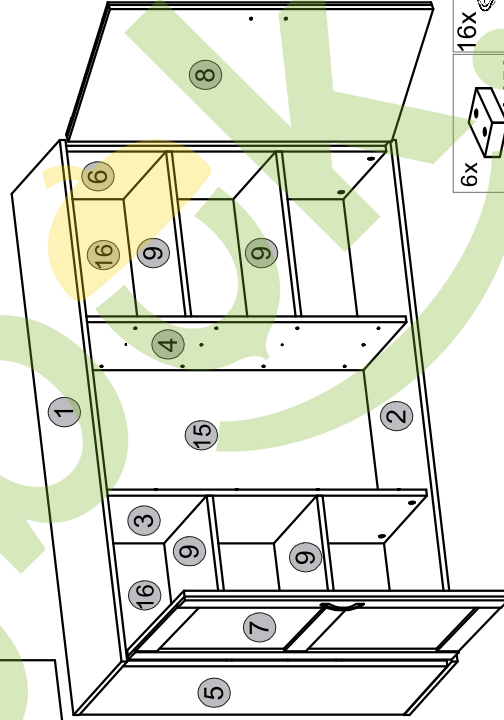
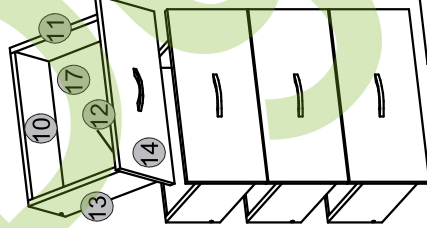
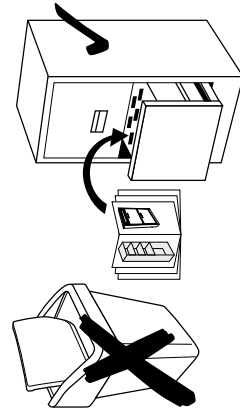
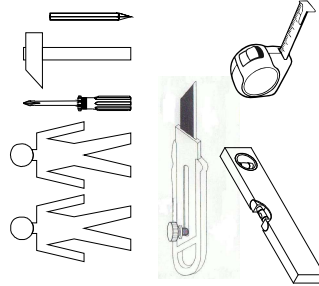
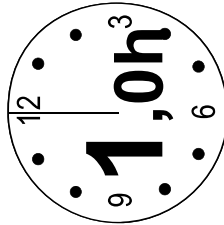
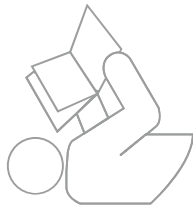
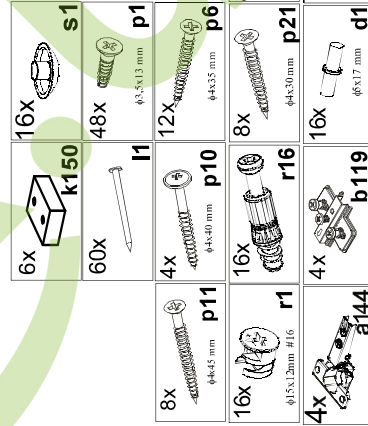

1

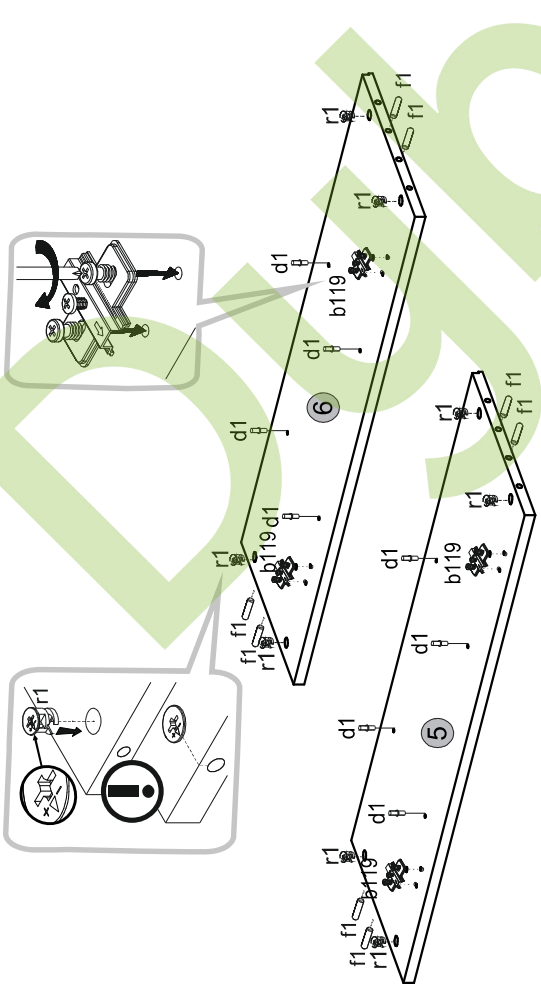

3

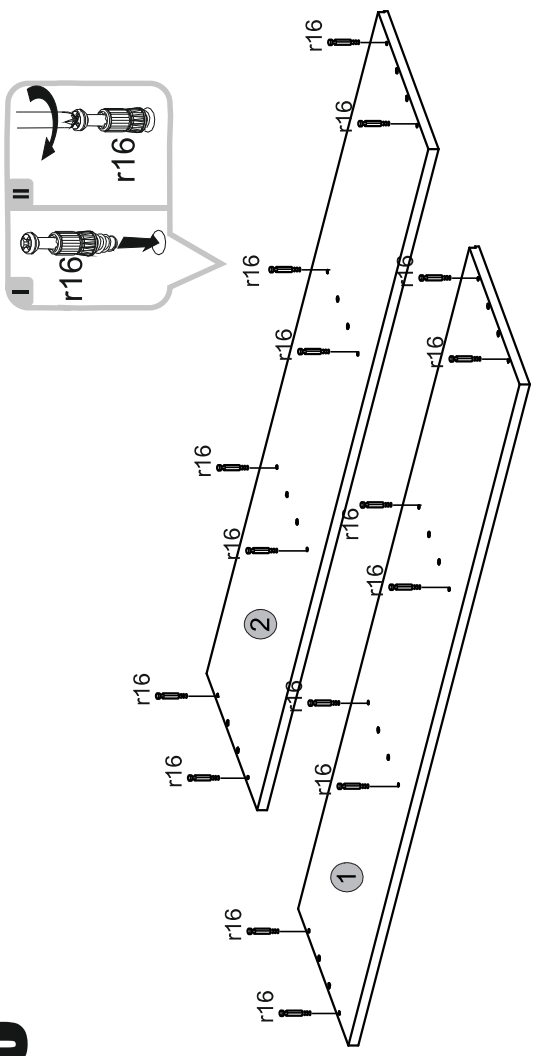

2

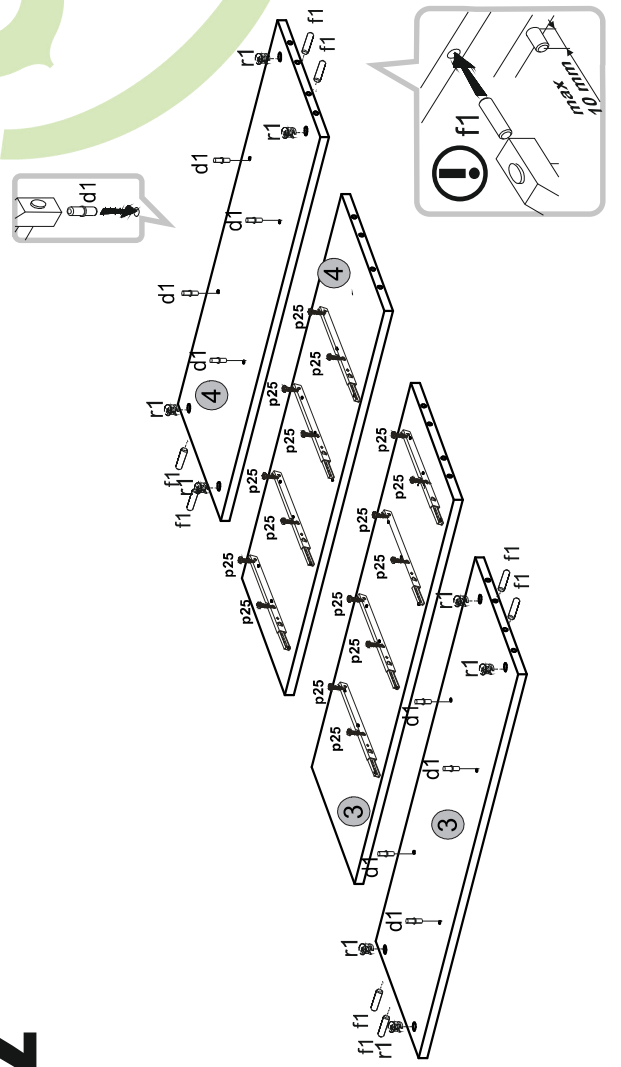

4

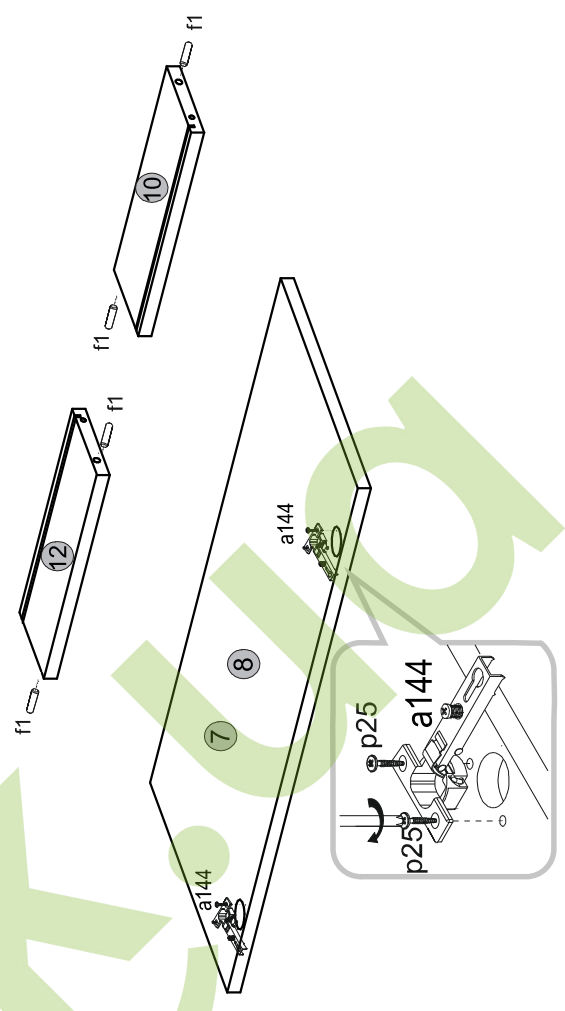

5

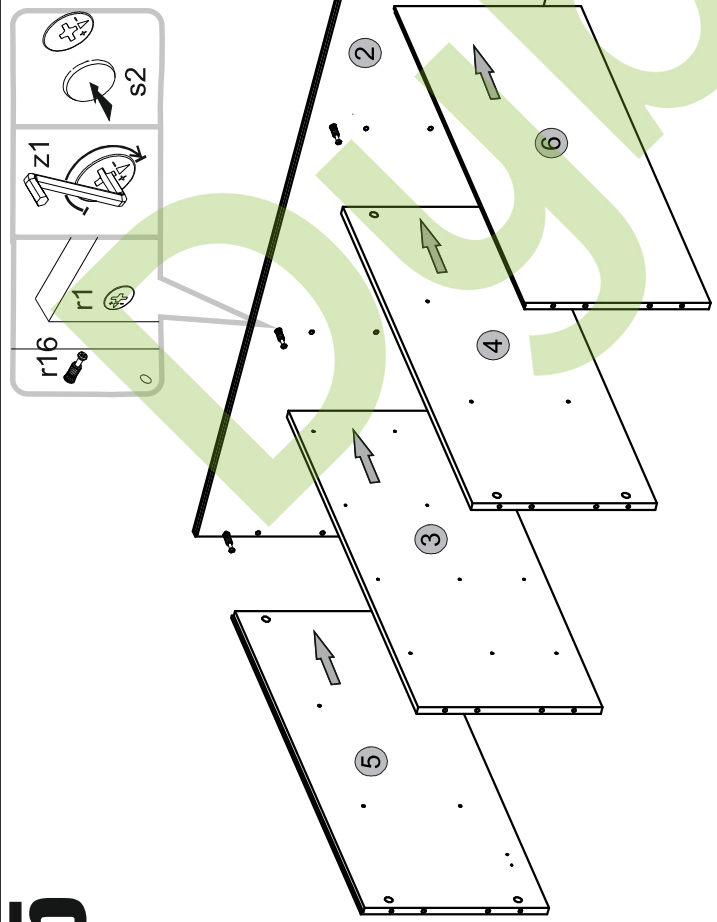

7

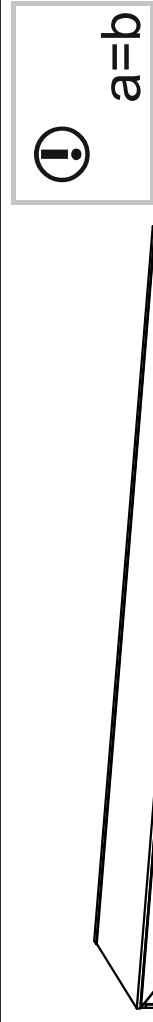

a=b

6

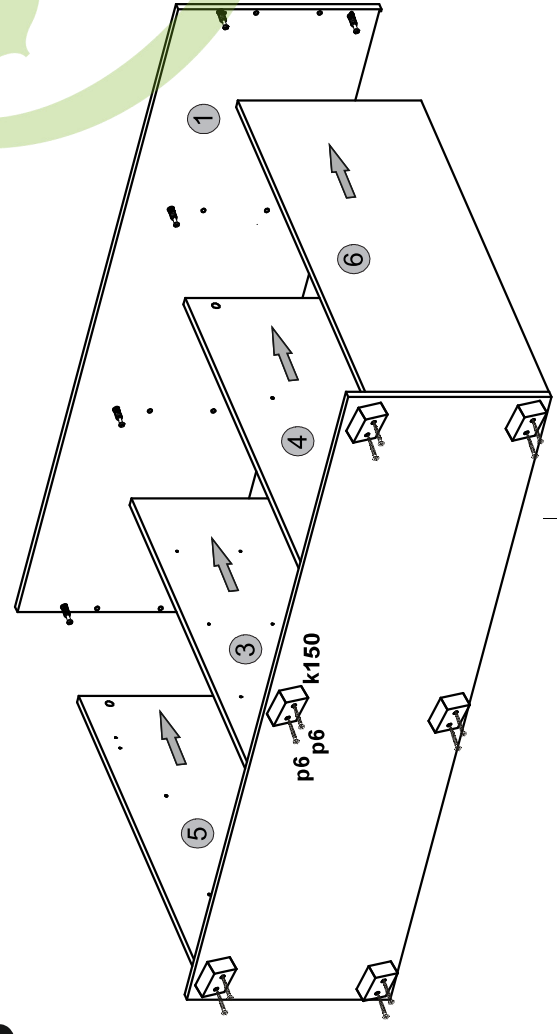

8

