

# Instalation manual

SOLO: SZF\_1D

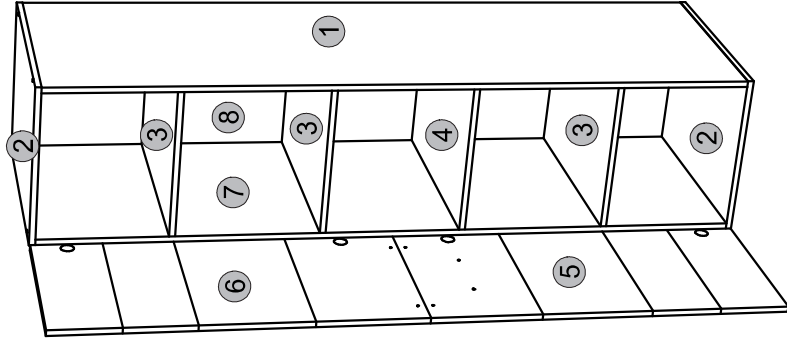

Element symbol	Dimensions	Code	Package
1	1913 574 16	1 SN-139	1/1
2	450 574 16	2 SN-218	1/1
3	415 571 16	3 SN-325	1/1
4	416 571 16	1 SN-324	1/1
5	970 448 16	1 SN-009	1/1
6	970 448 16	1 SN-011	1/1
7	1913 574 16	1 SN-140	1/1
8	1932 434 3	1 SN-624	1/1

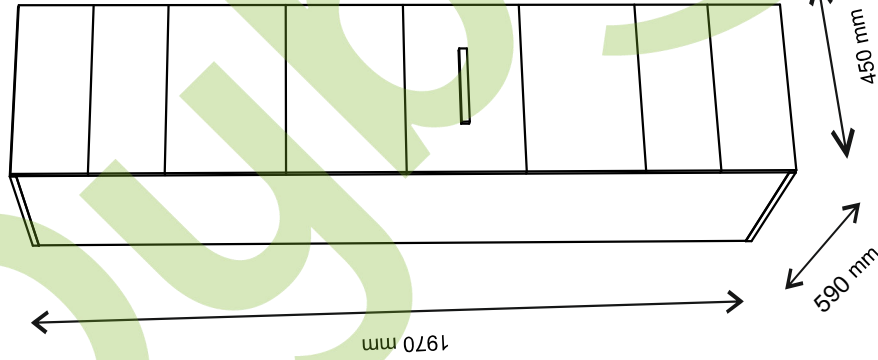
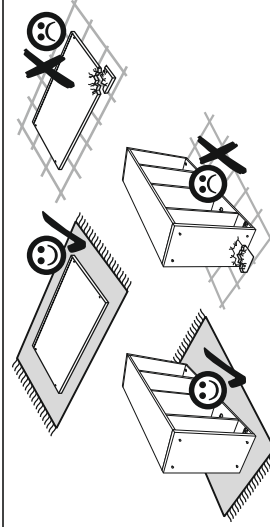
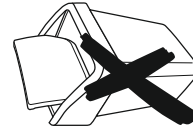
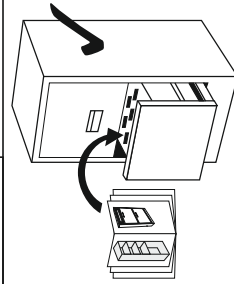
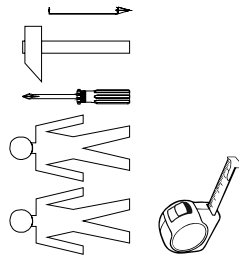
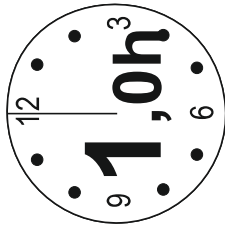
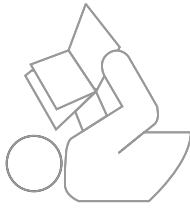
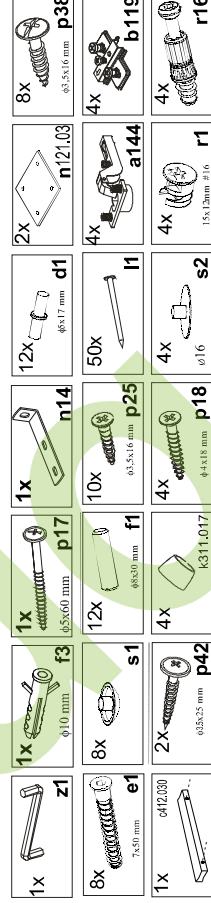

1

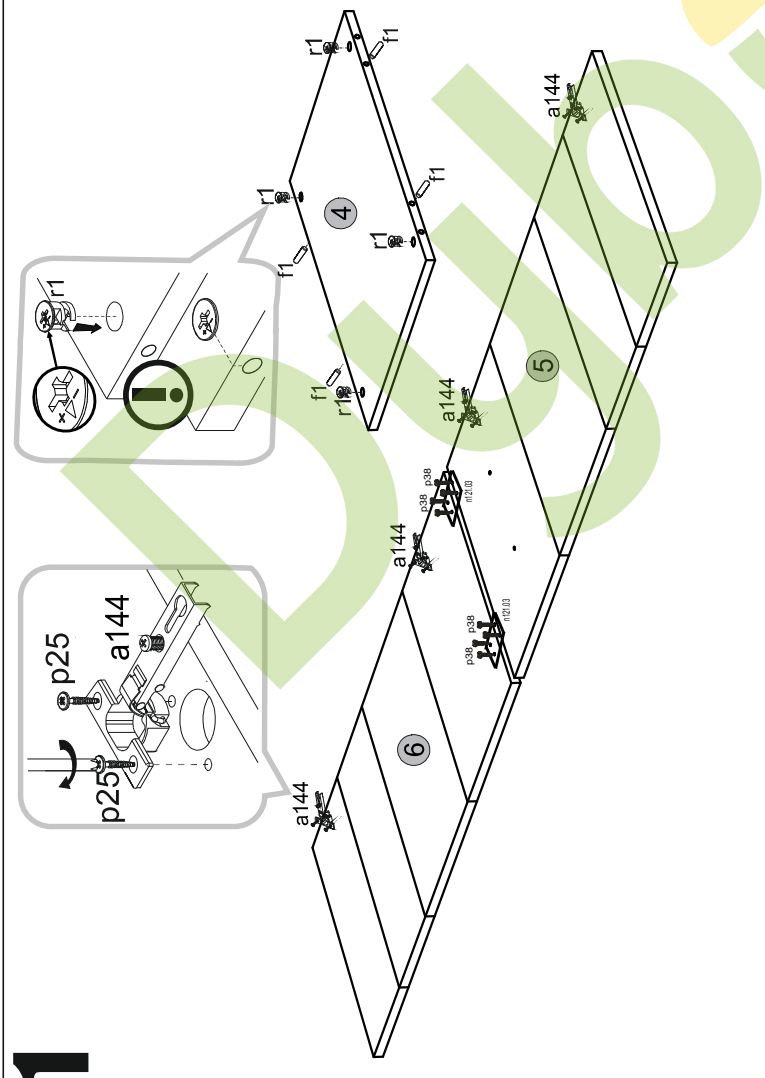

3

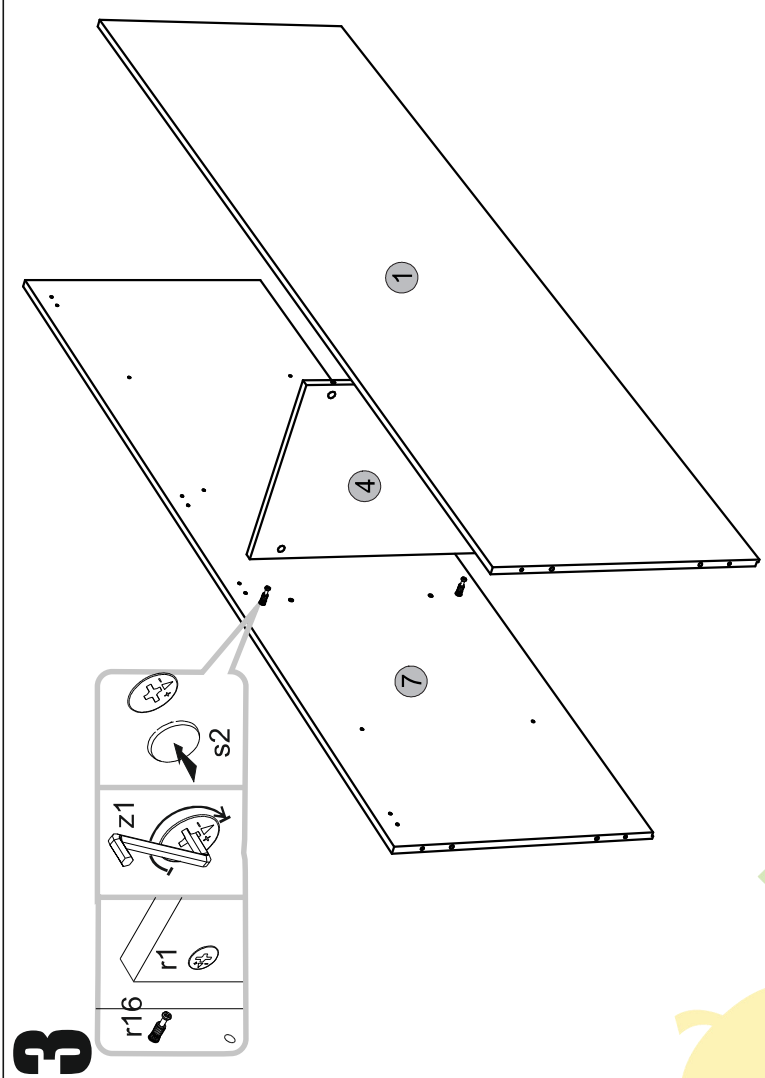

2

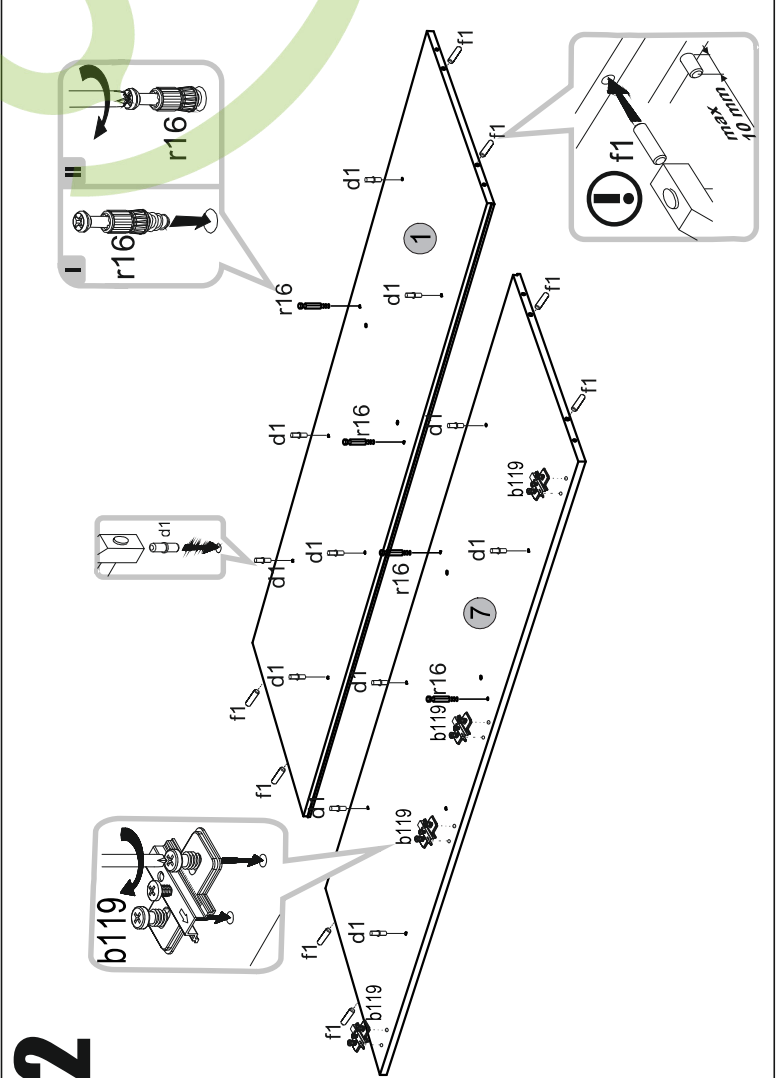

4

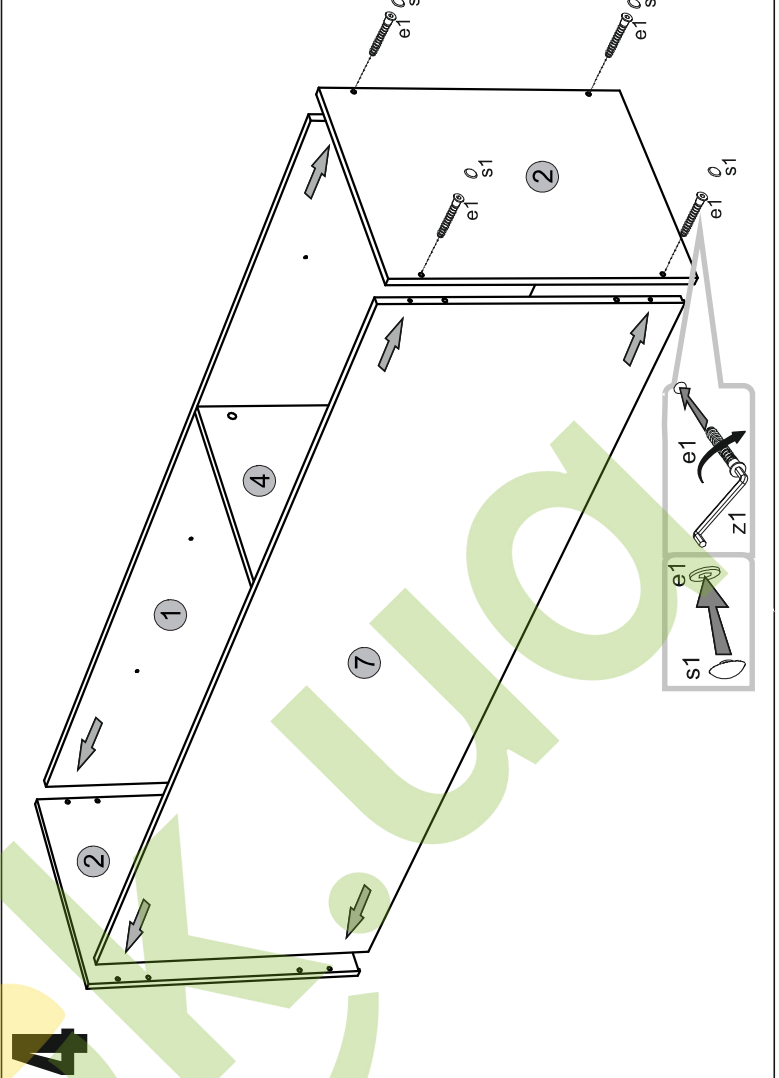

5

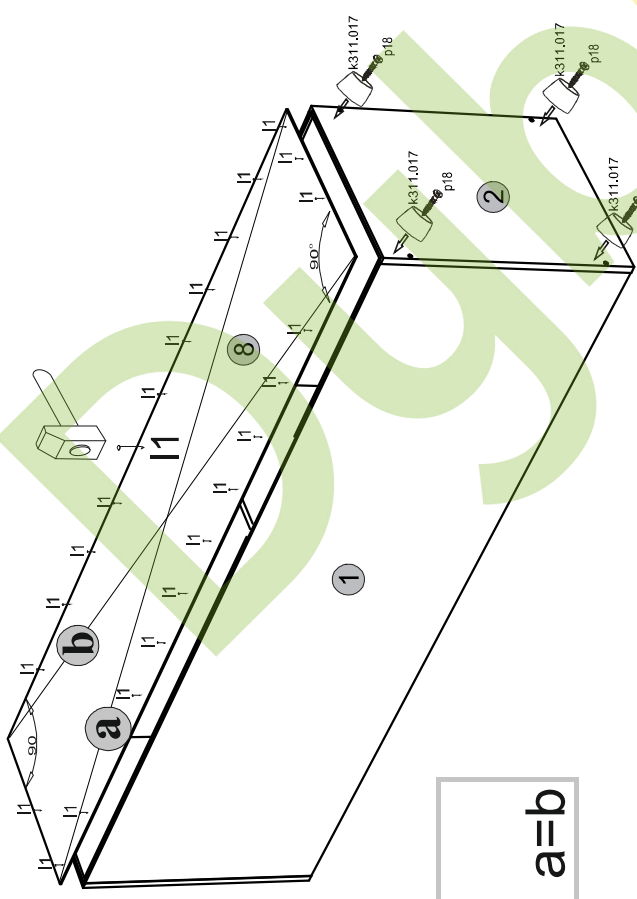

**!** a=b

6

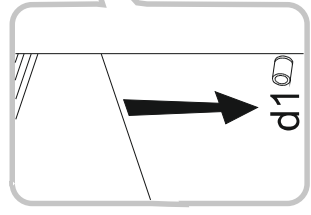
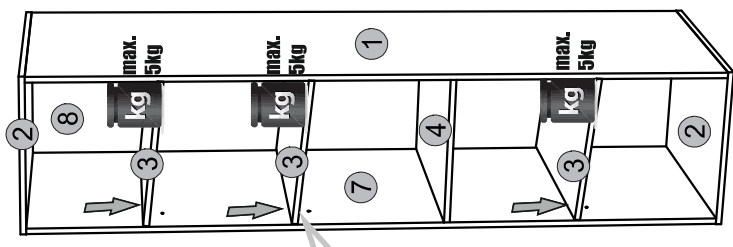

7

