

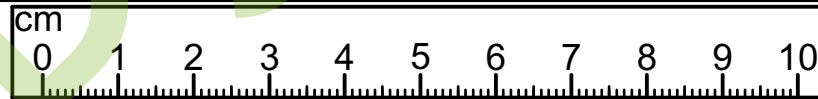

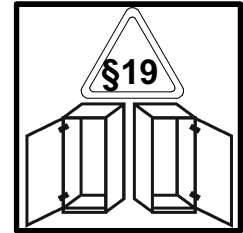









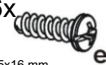
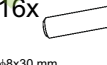

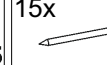

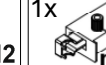
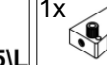

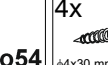
A	B	C (mm)		D
1	S205-111	1001	330	1/5
2	S205-112	1001	330	1/5
3	S205-209	600	330	1/5
4	S205-302	567	300	1/5
5	S205-303	560	280	3/5
6	S205-551	563	469	4/5
7	S205-582	345	100	1/5
8	S205-701	403	596	5/5
9	S205-702	200	596	5/5
10	S205-311	567	330	1/5
11	S205-953	994	288	1/5
12	S205-954	994	288	1/5
13	Lh-977	977	14	1/5
14	qc33/1			5/5



- 3x  **a102**
- 3x  **b59**
- 4x  **d33**
- 6x  $\phi 5 \times 16$ mm **e47**
- 16x  $\phi 8 \times 30$ mm **f1**
- 2x  $\phi 10 \times 50$ mm **f35**
- 15x  **l1**
- 12x  **l2**
- 1x  **n165L**
- 1x  **n165P**
- 6x  $\phi 5,3 \times \phi 8,3 \times 4,8$ mm **o54**
- 4x  $\phi 4 \times 30$ mm **p9**
- 4x  $\phi 3,5 \times 16$ mm **p38**
- 6x  $\phi 3,5 \times 15$ mm **p51**
- 2x  $\phi 6 \times 60$ mm **p127**
- 16x  $\phi 15 \times 12$ mm #16 **r1**
- 16x  **r42**
- 16x  $\phi 16$ **s2**
- 6x  $\phi 5$ **s4**
- 3x  $\phi 35$ mm **s33**
- 6x  $\phi 12 \times 0,5$ mm **s59**

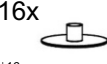

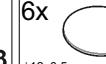
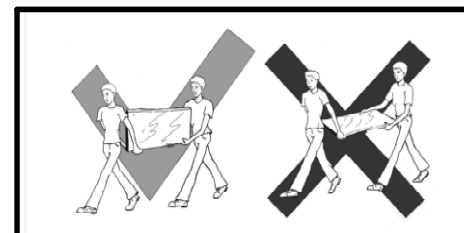
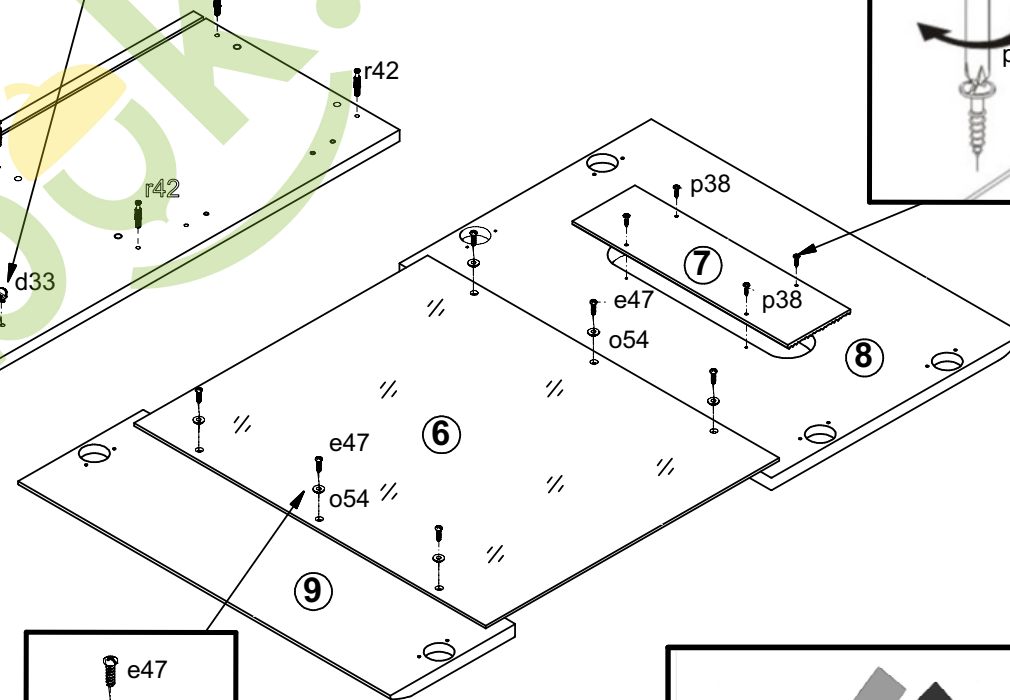
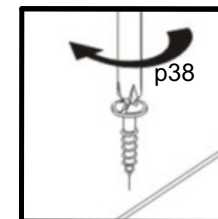
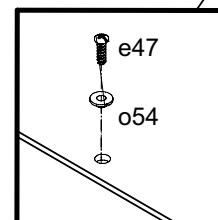
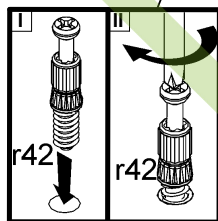
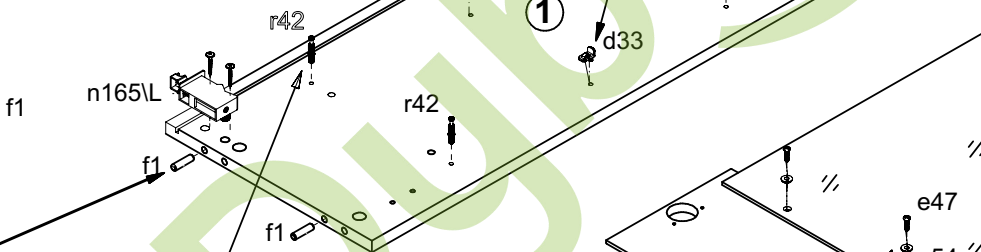
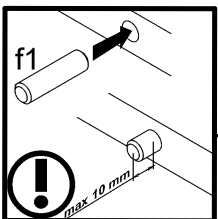
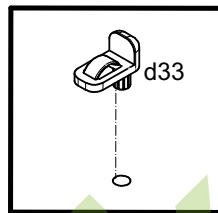
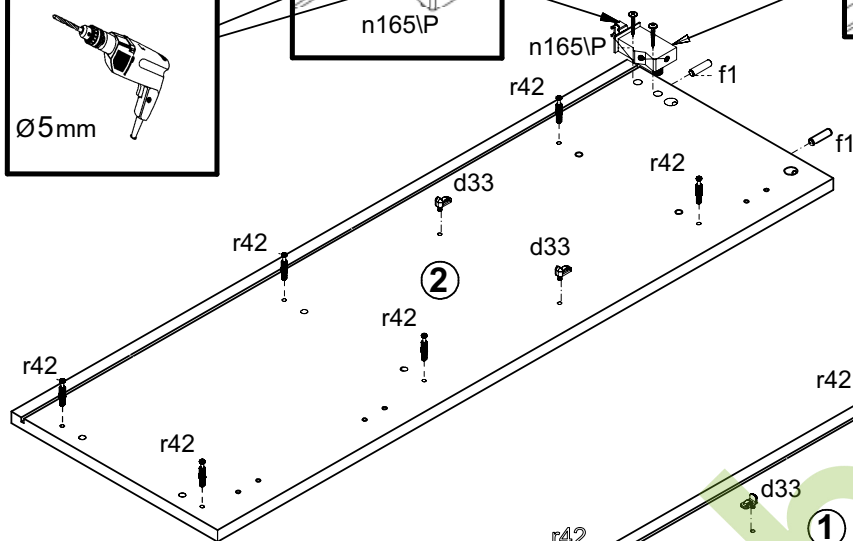
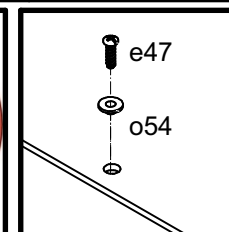
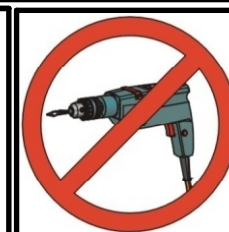
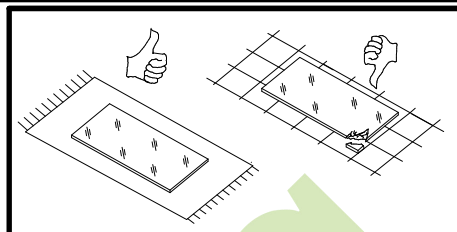
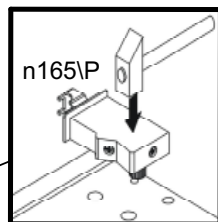
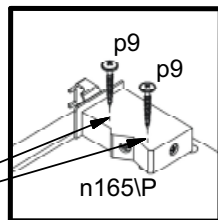
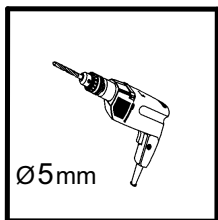
2 

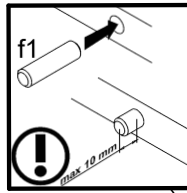

3

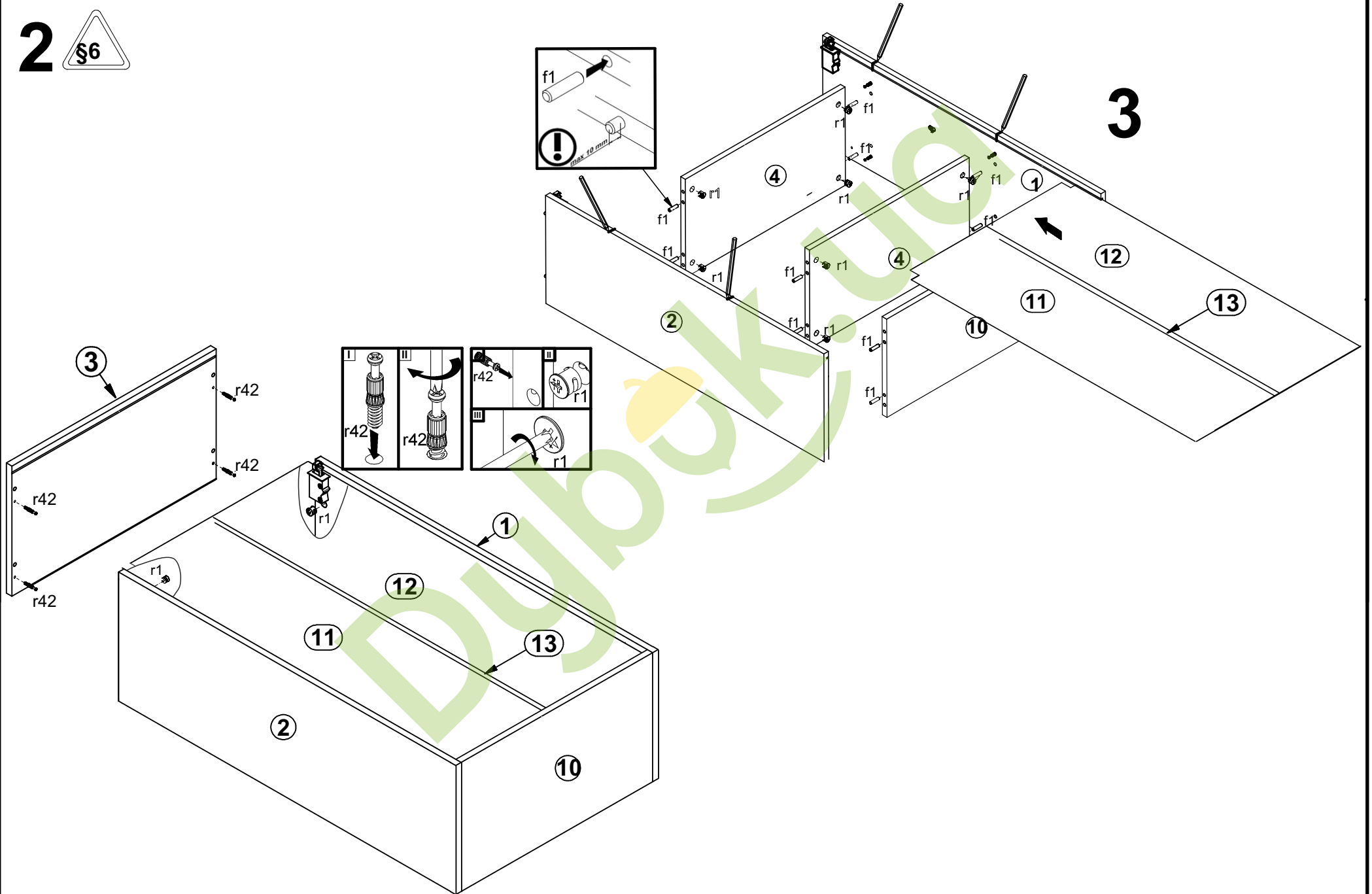

4

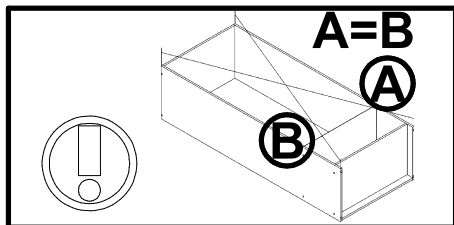
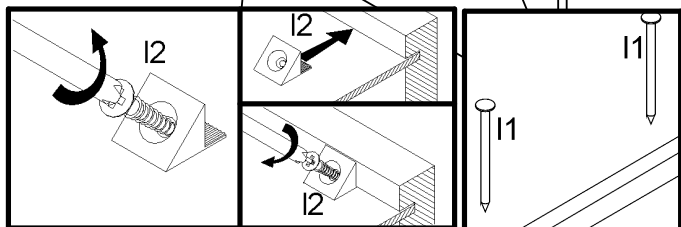
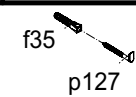
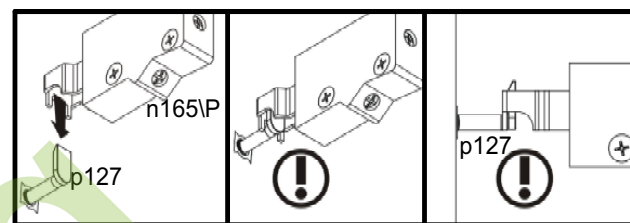
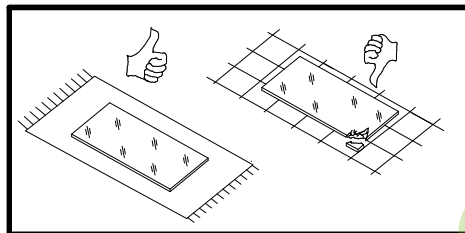
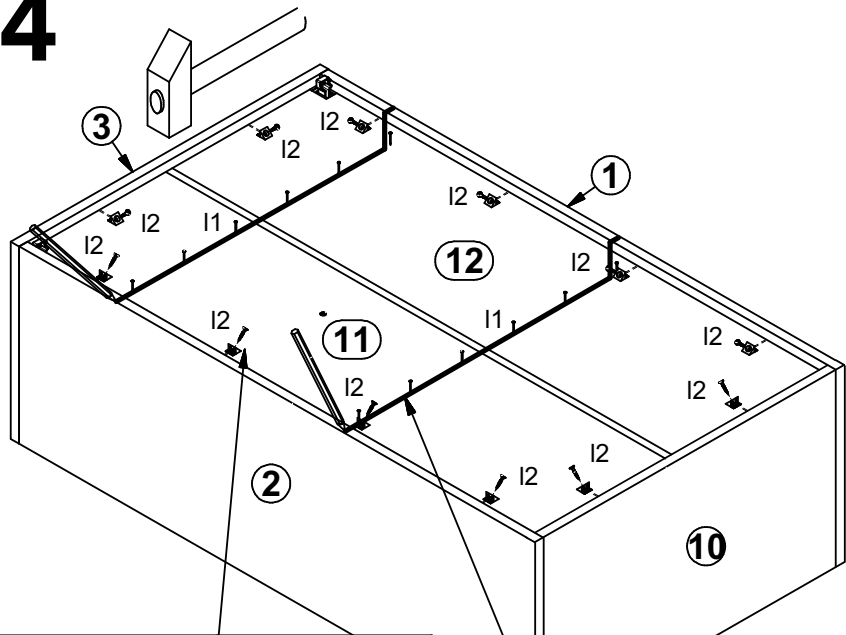

5

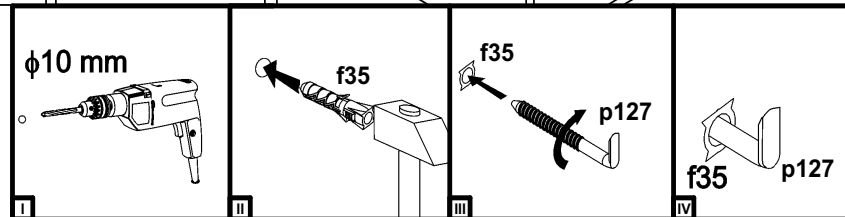
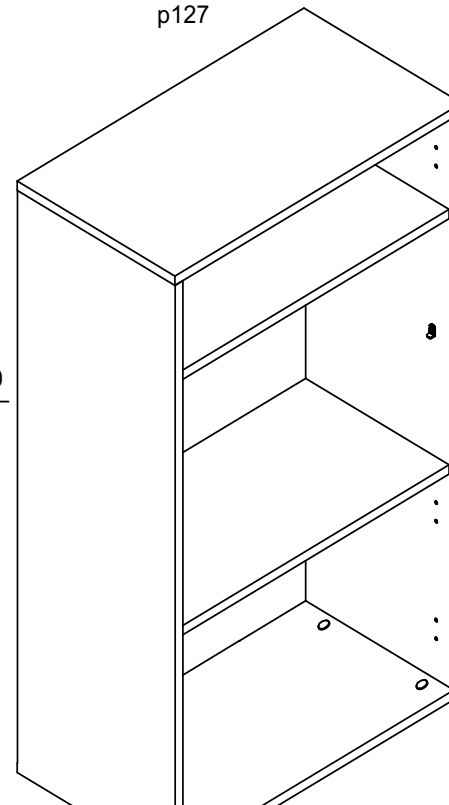
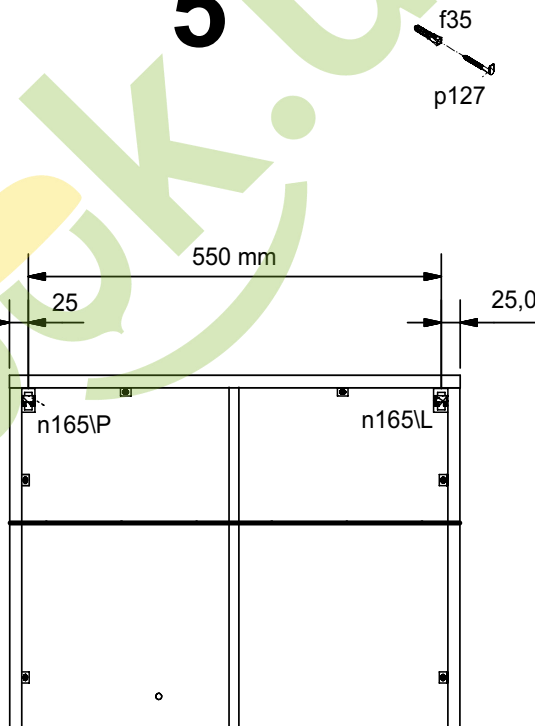

6 

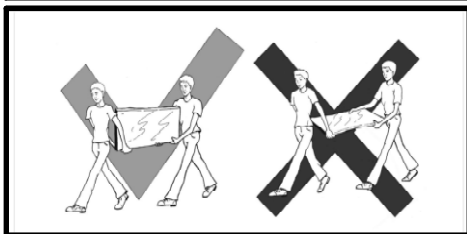
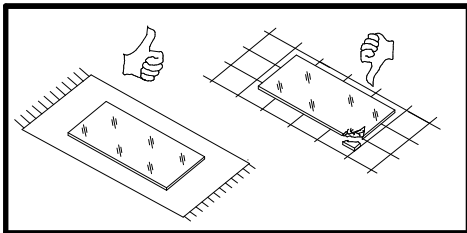
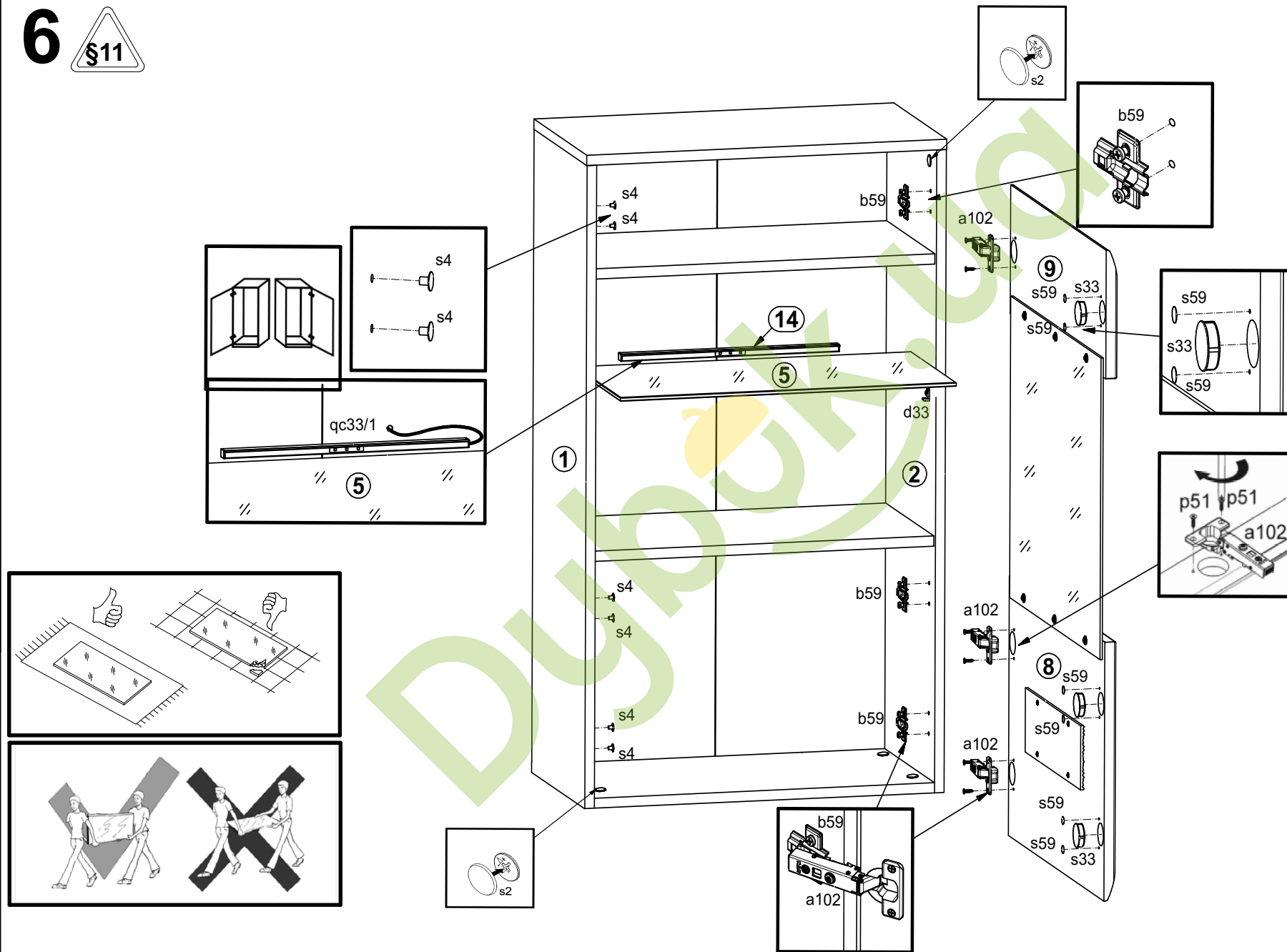

7

