

A	B	C		D
1	S205-029	1418	396	3/6
2	S205-140	1390	390	2/6
3	S205-141	1390	390	2/6
4	S205-142	1390	364	2/6
5	S205-223	900	390	1/6
6	S205-224	900	390	1/6
7	S205-306	475	360	1/6
8	S205-308	469	340	4/6
9	S205-314	475	360	1/6
10	S205-315	374	360	1/6
11	S205-556	480	469	5/6
12	S205-583	370	100	3/6
13	S205-586	270	100	3/6
14	S205-717	809	496	3/6
15	S205-719	200	496	3/6
16	S205-916	1400	388	2/6
17	S205-960	1400	244	2/6
18	S205-961	1400	244	2/6
19	Lh-1385	1385	14	2/6

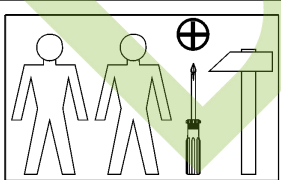

6x a102	6x b59	16x d1 φ5x17 mm	4x d33	6x e1 φ7x50 mm	6x e47 φ5x16 mm	20x f1 φ8x30 mm	2x k84	3x k85
12x l1	18x l2	9x n108 20x13x3,5/1	1x o4316	1x o4318	6x o54 φ5,3/φ8,3x4,8 mm	15x p38 φ3,5x16 mm	12x p51 φ3,5x15 mm	9x p55 φ2,9x16 mm
6x p6 φ4x35 mm	14x r1 φ15x12 mm #16	14x r42	14x s2 φ16	1x z1	1x n2611	32x s4 φ5	1x p17 φ5x60 mm	1x f35 φ10x50 mm

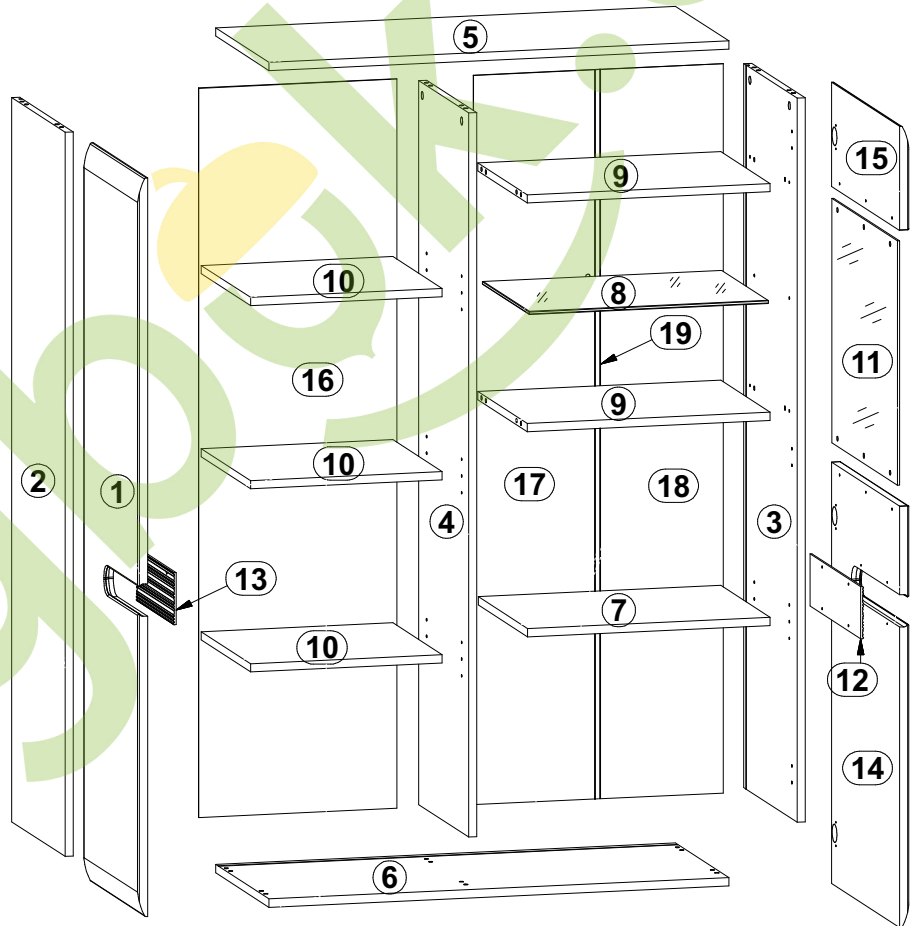
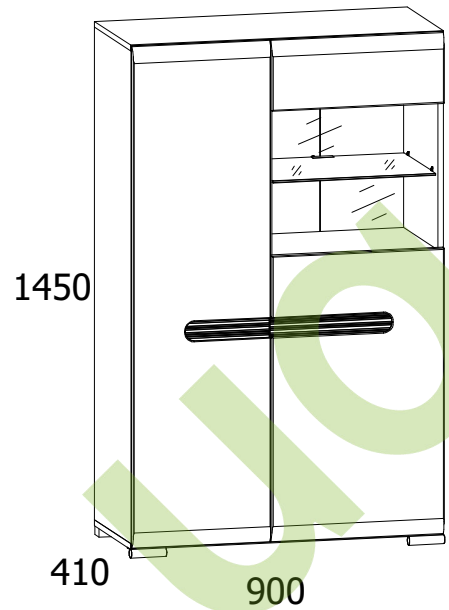
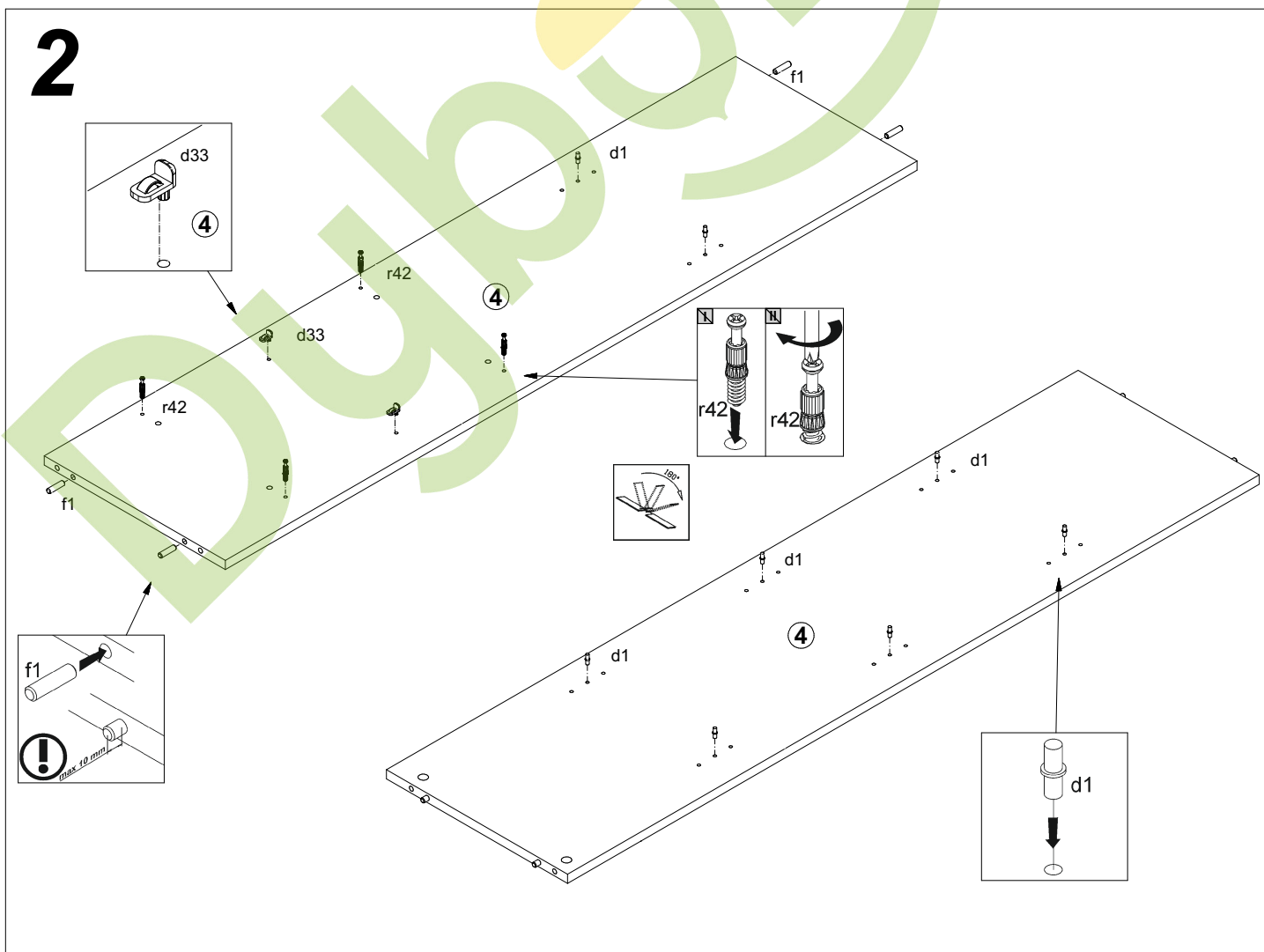
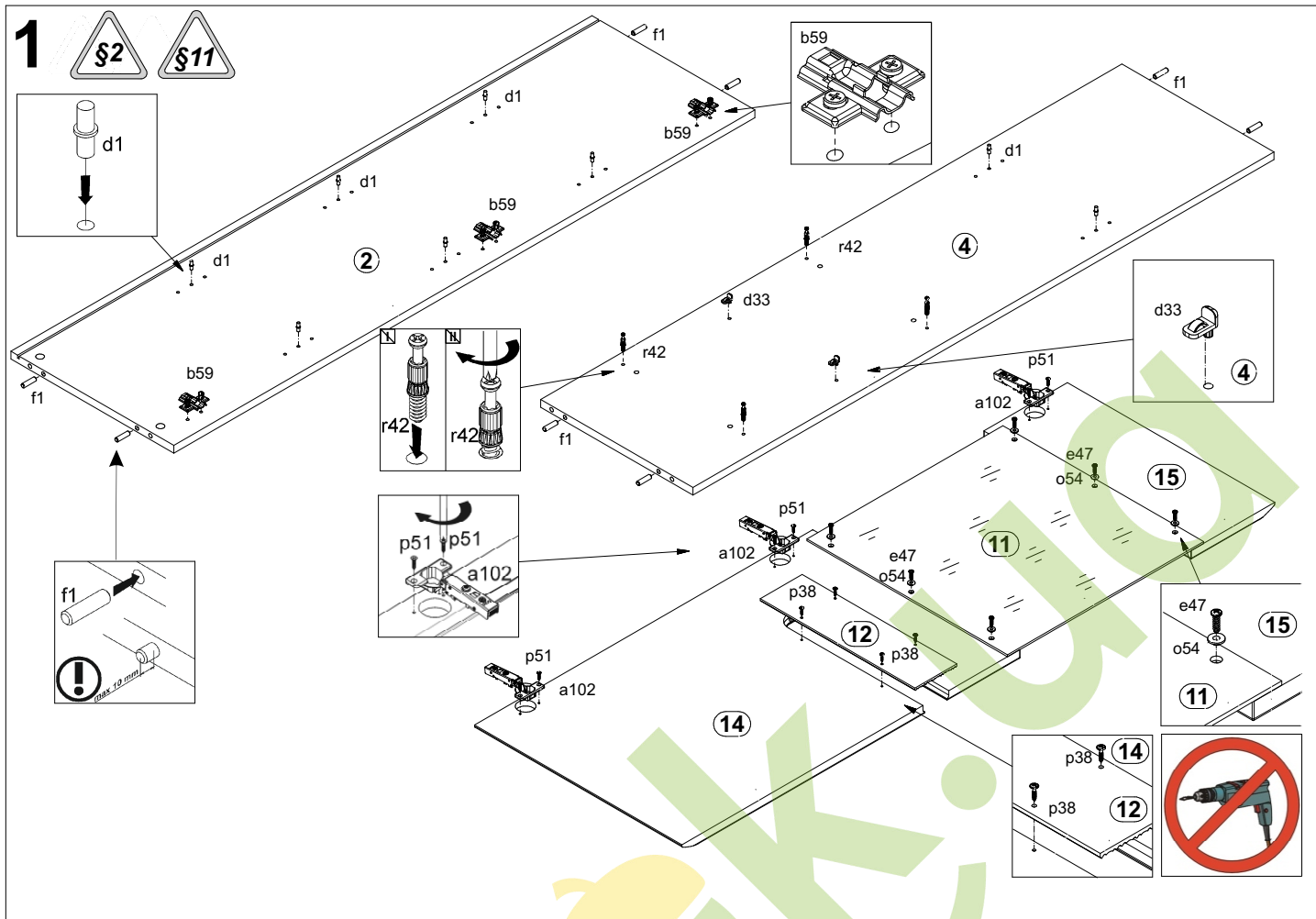

3

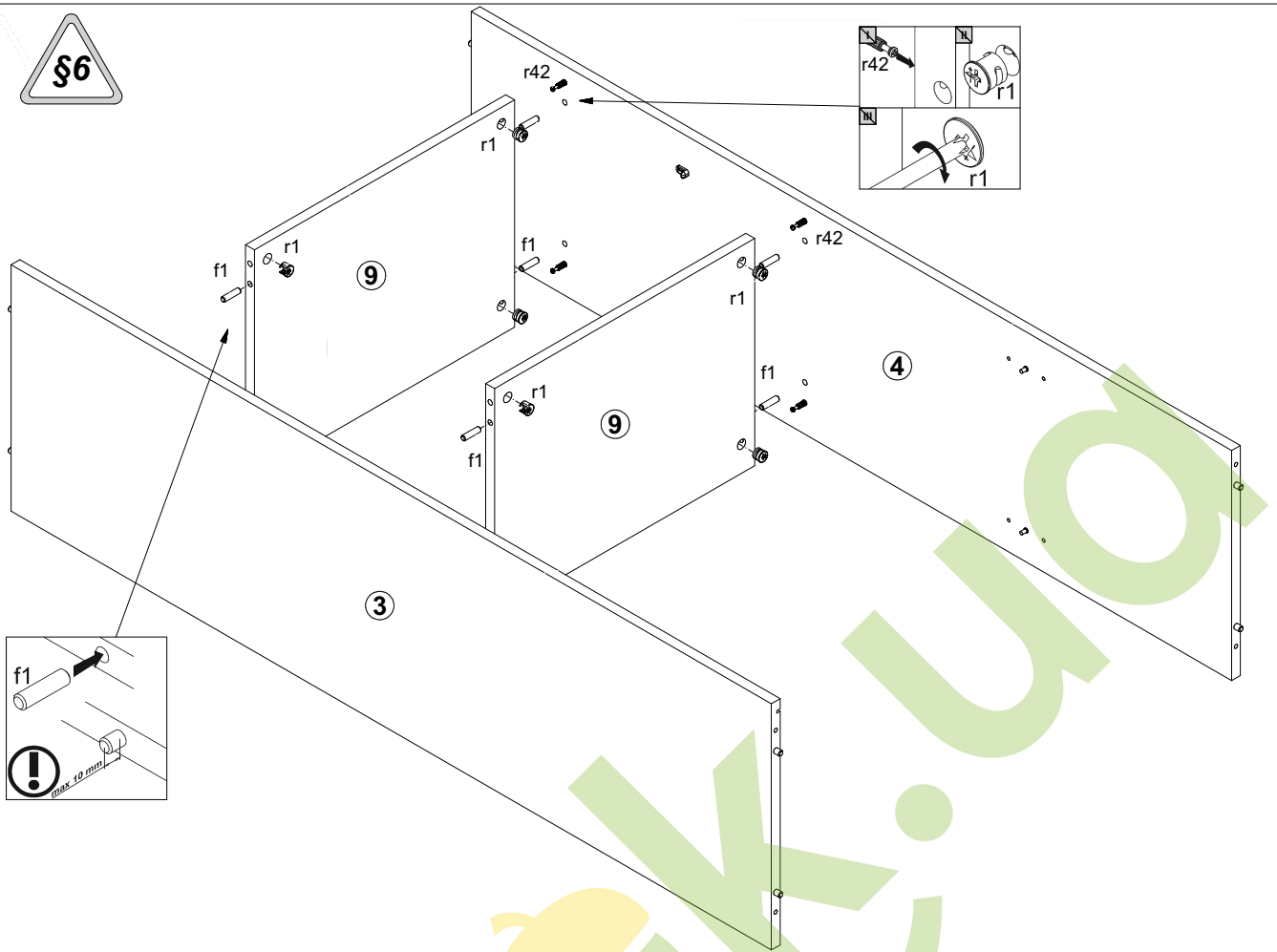

4

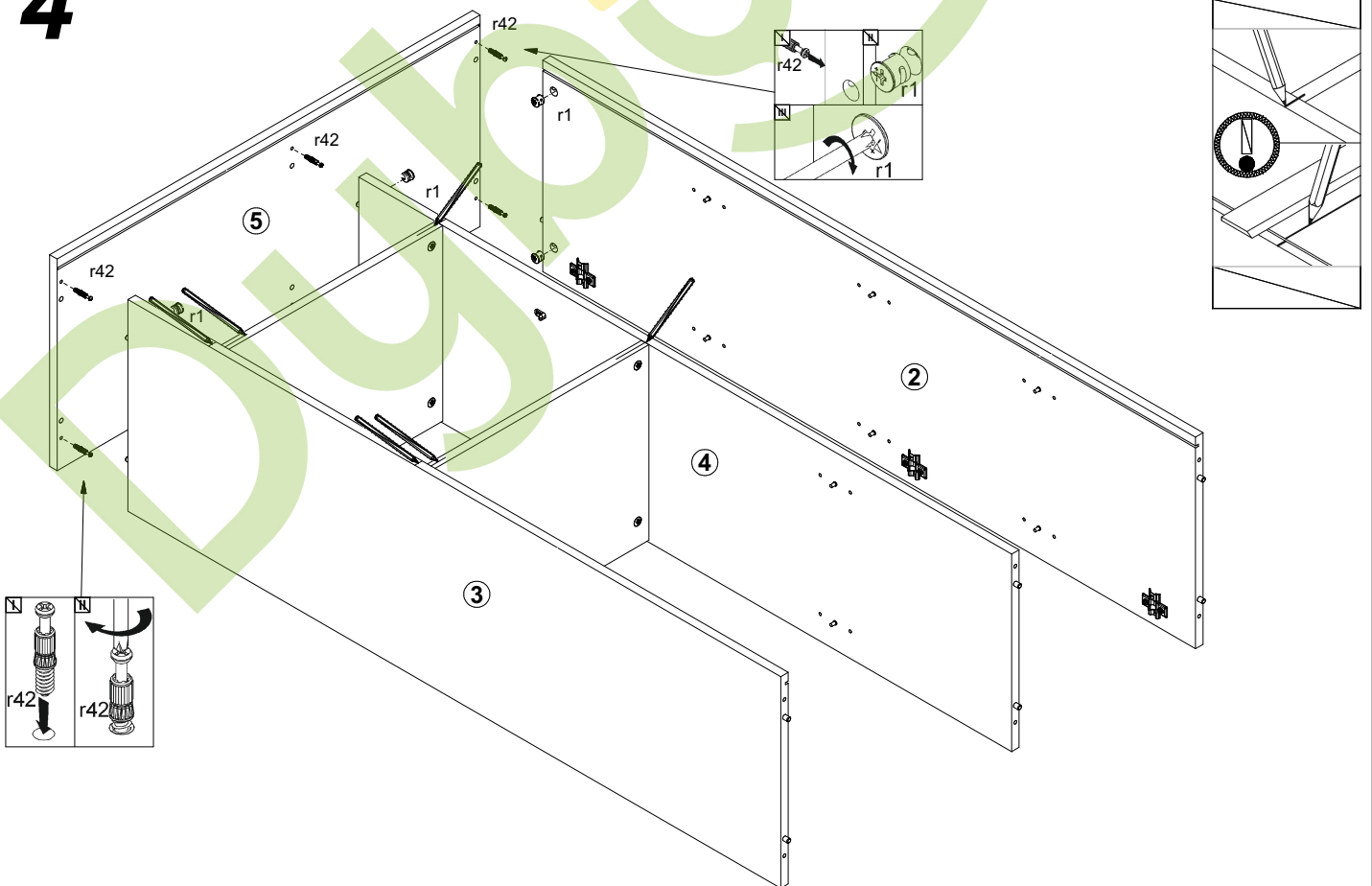

5

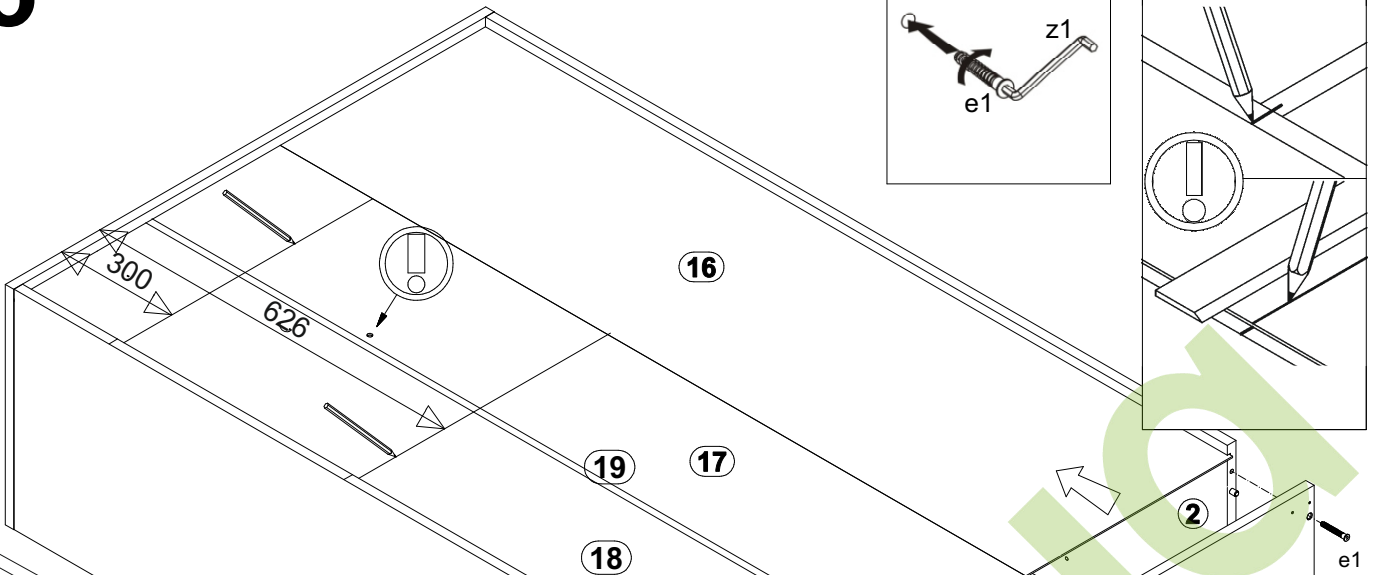
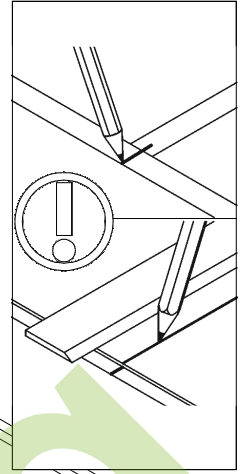
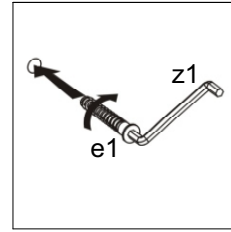

6

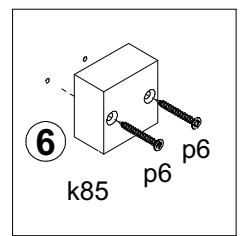
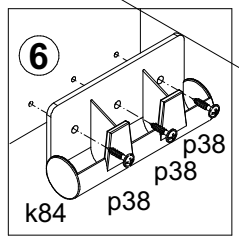
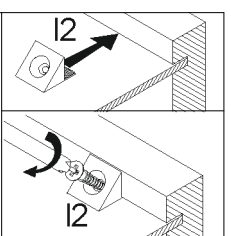
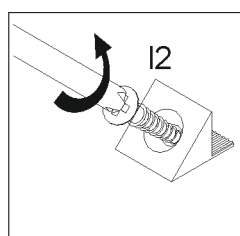
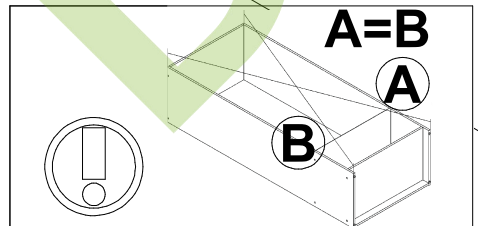
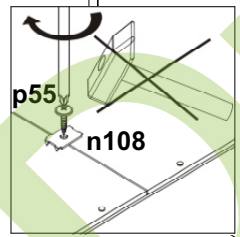
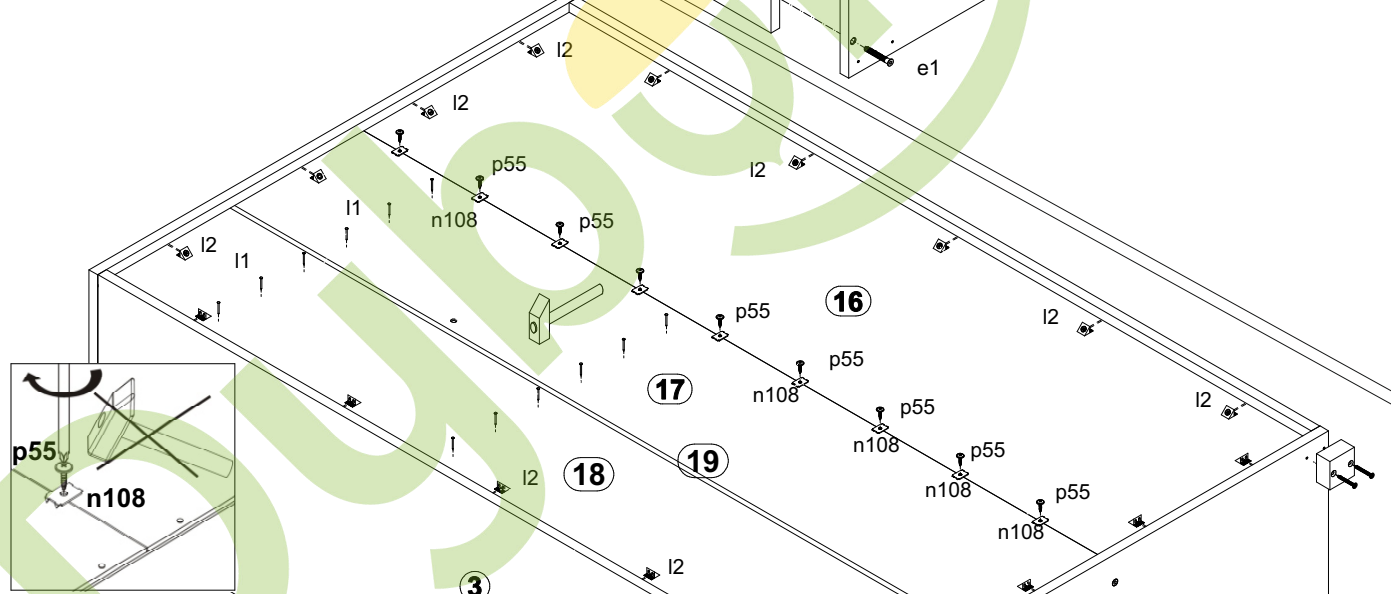
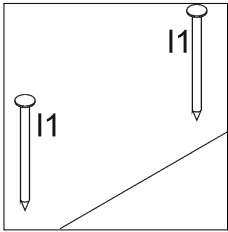

7

