

| A | B | C | D | |
|----|----------|------|-----|-----|
| 1 | S205-028 | 2071 | 396 | 3/6 |
| 2 | S205-137 | 2043 | 390 | 2/6 |
| 3 | S205-138 | 2043 | 390 | 2/6 |
| 4 | S205-139 | 2043 | 364 | 2/6 |
| 5 | S205-221 | 900 | 390 | 1/6 |
| 6 | S205-222 | 900 | 390 | 1/6 |
| 7 | S205-306 | 474 | 360 | 1/6 |
| 8 | S205-716 | 809 | 496 | 3/6 |
| 9 | S205-314 | 475 | 360 | 1/6 |
| 10 | S205-315 | 374 | 360 | 1/6 |
| 11 | S205-553 | 919 | 480 | 5/6 |
| 12 | S205-583 | 370 | 100 | 3/6 |
| 13 | S205-586 | 270 | 100 | 3/6 |
| 14 | S205-308 | 469 | 340 | 4/6 |
| 15 | S205-718 | 403 | 496 | 3/6 |
| 16 | S205-915 | 2053 | 388 | 2/6 |
| 17 | S205-958 | 2053 | 244 | 2/6 |
| 18 | S205-958 | 2053 | 244 | 2/6 |
| 19 | Lh-2035 | 2035 | 14 | 2/6 |

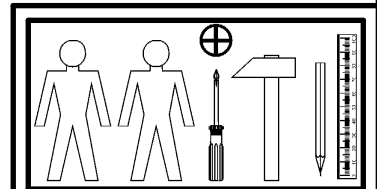

| | | | | | | | | |
|----------------|---------------|-----------------|-----------------|-----------------|-----------------|----------------|----------------|----------------|
| 8x a102 | 8x b59 | 20x d1 | 8x d33 | 6x e1 | 6x e47 | 20x f1 | 2x k84 | 3x k85 |
| 12x l1 | 22x l2 | 12x n108 | 2x o4318 | 1x o4316 | 6x o54 | 15x p38 | 16x p51 | 12x p55 |
| 6x p6 | 14x r1 | 14x r42 | 14x s2 | 1x z1 | 1x n2611 | 40x s4 | | |

1 

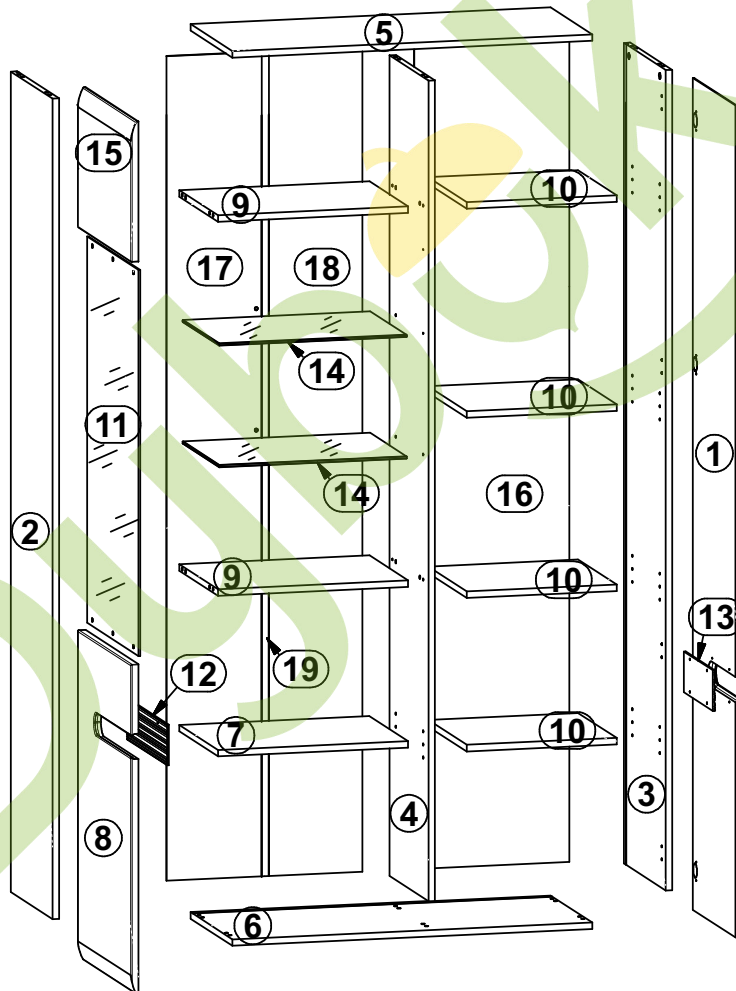
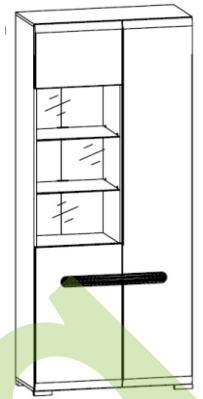
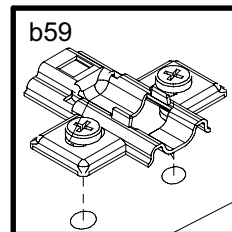
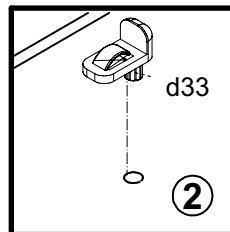
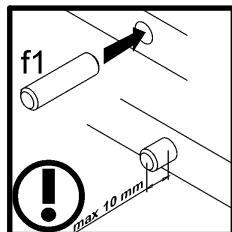
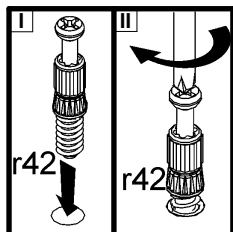
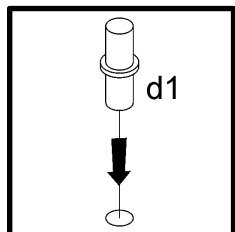
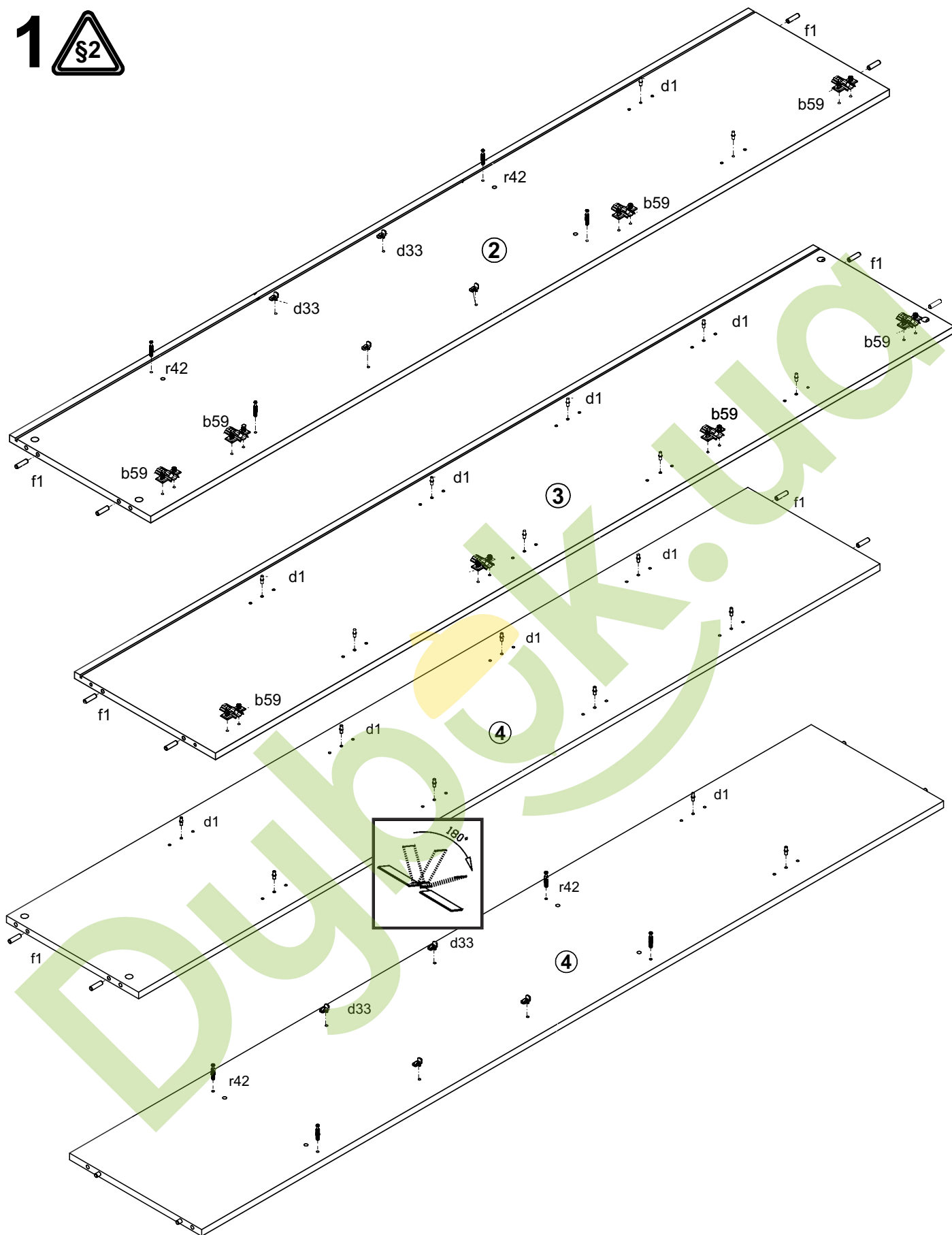

3

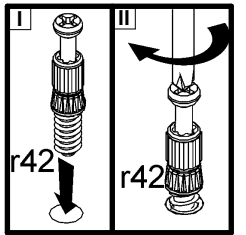
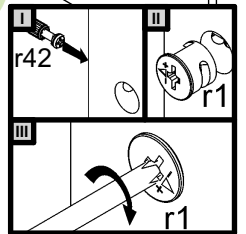
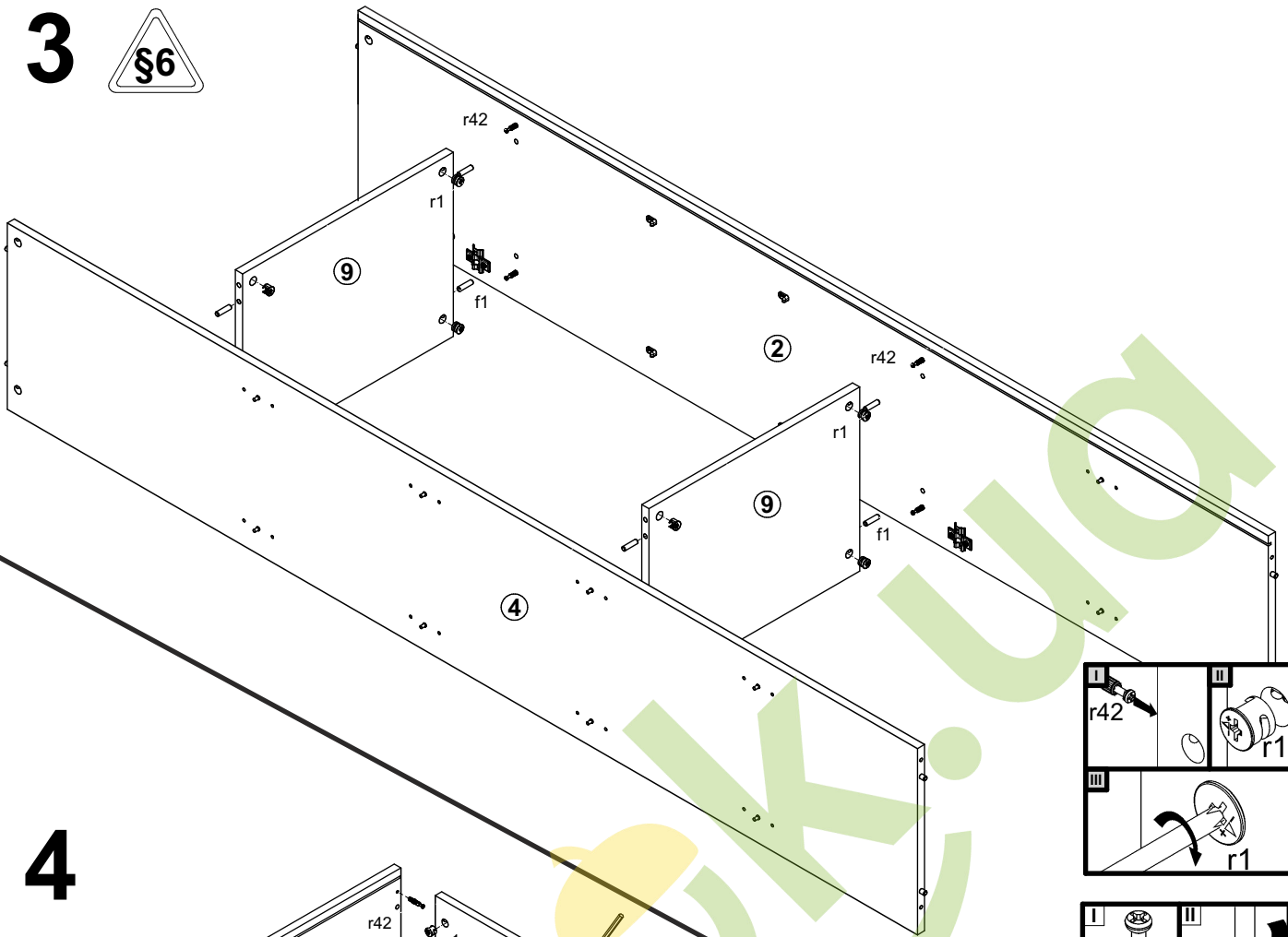

4

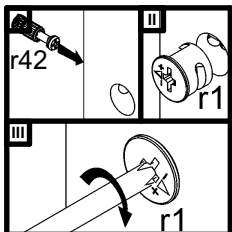
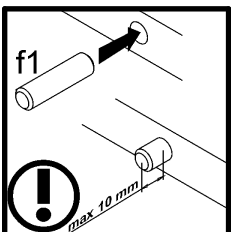
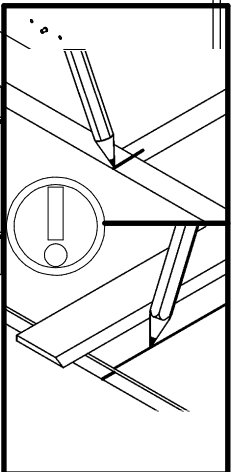
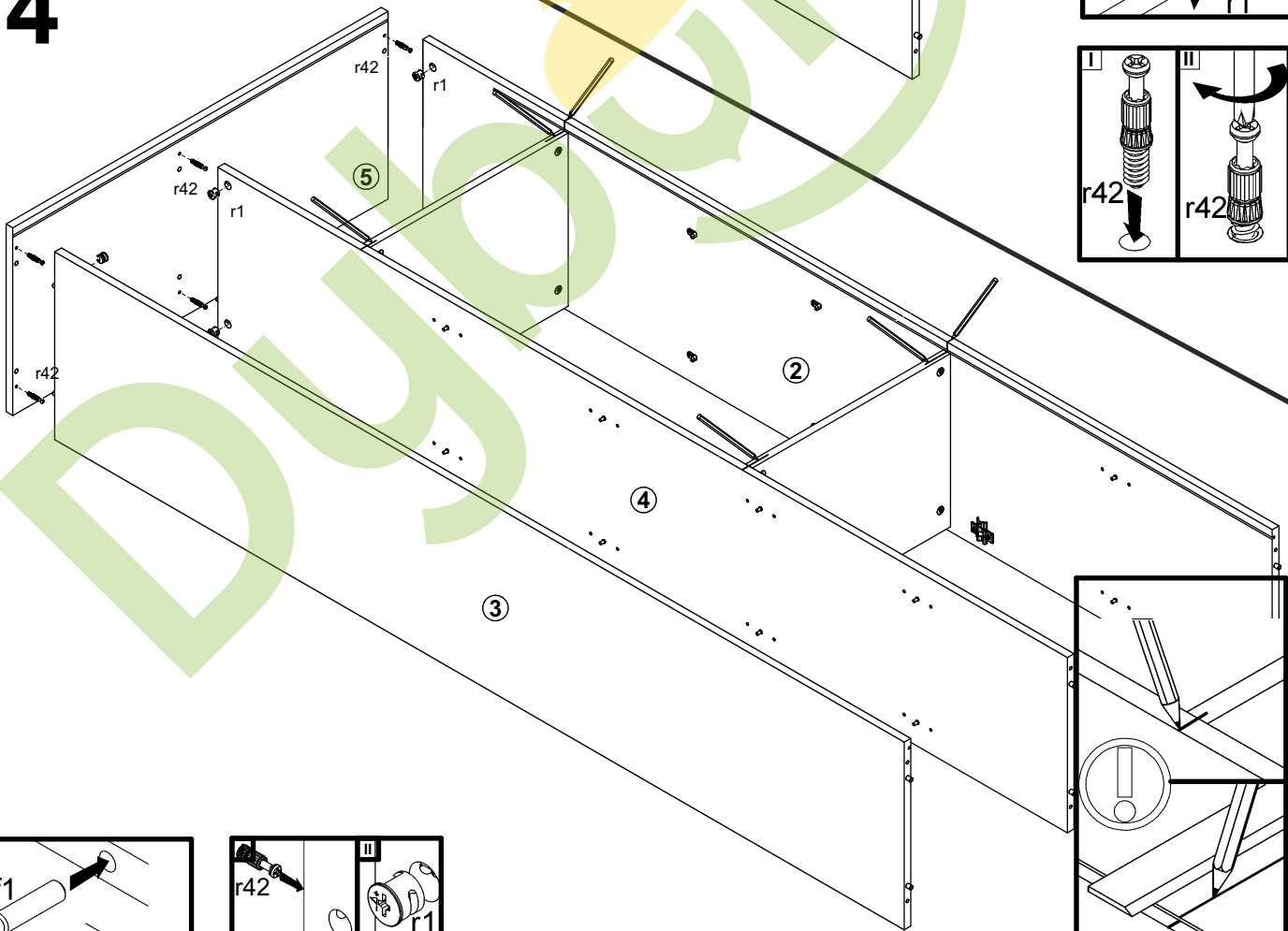

5

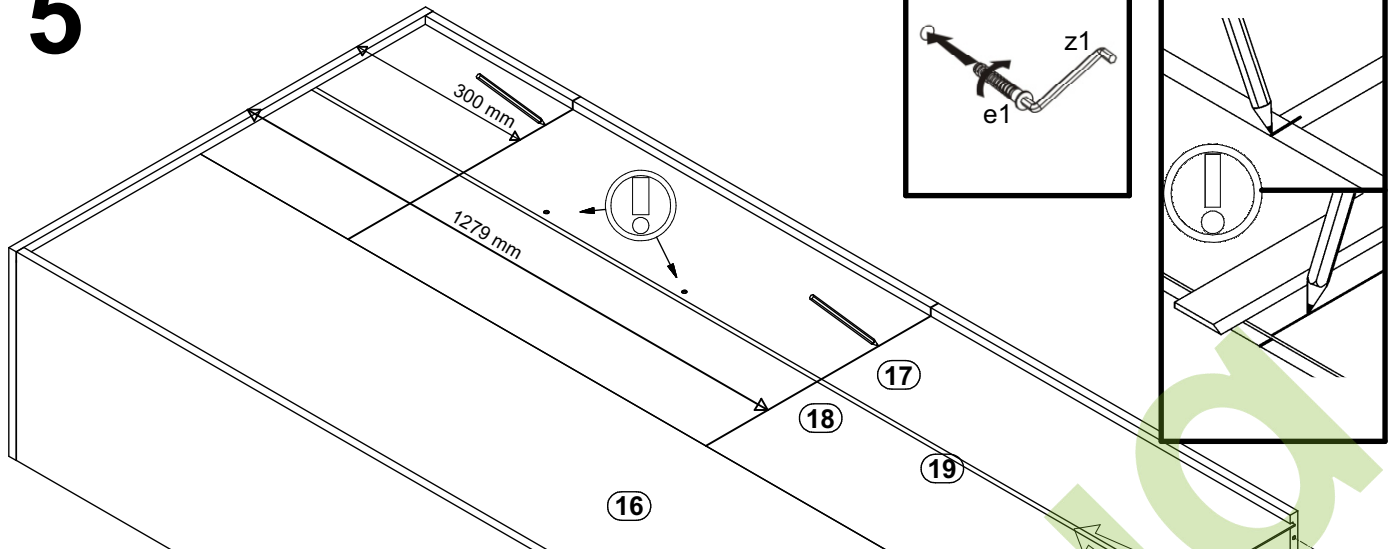

6

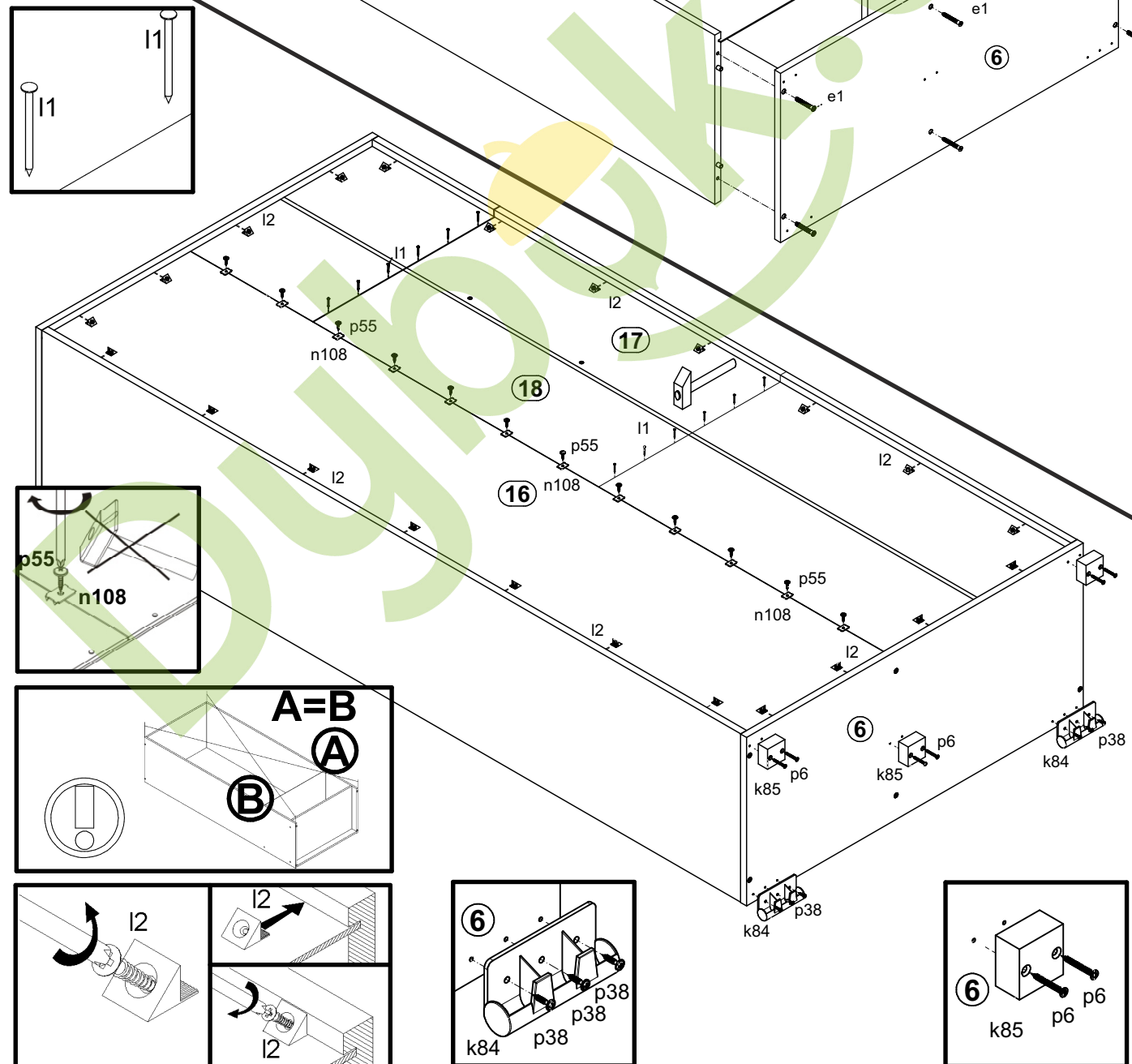

7

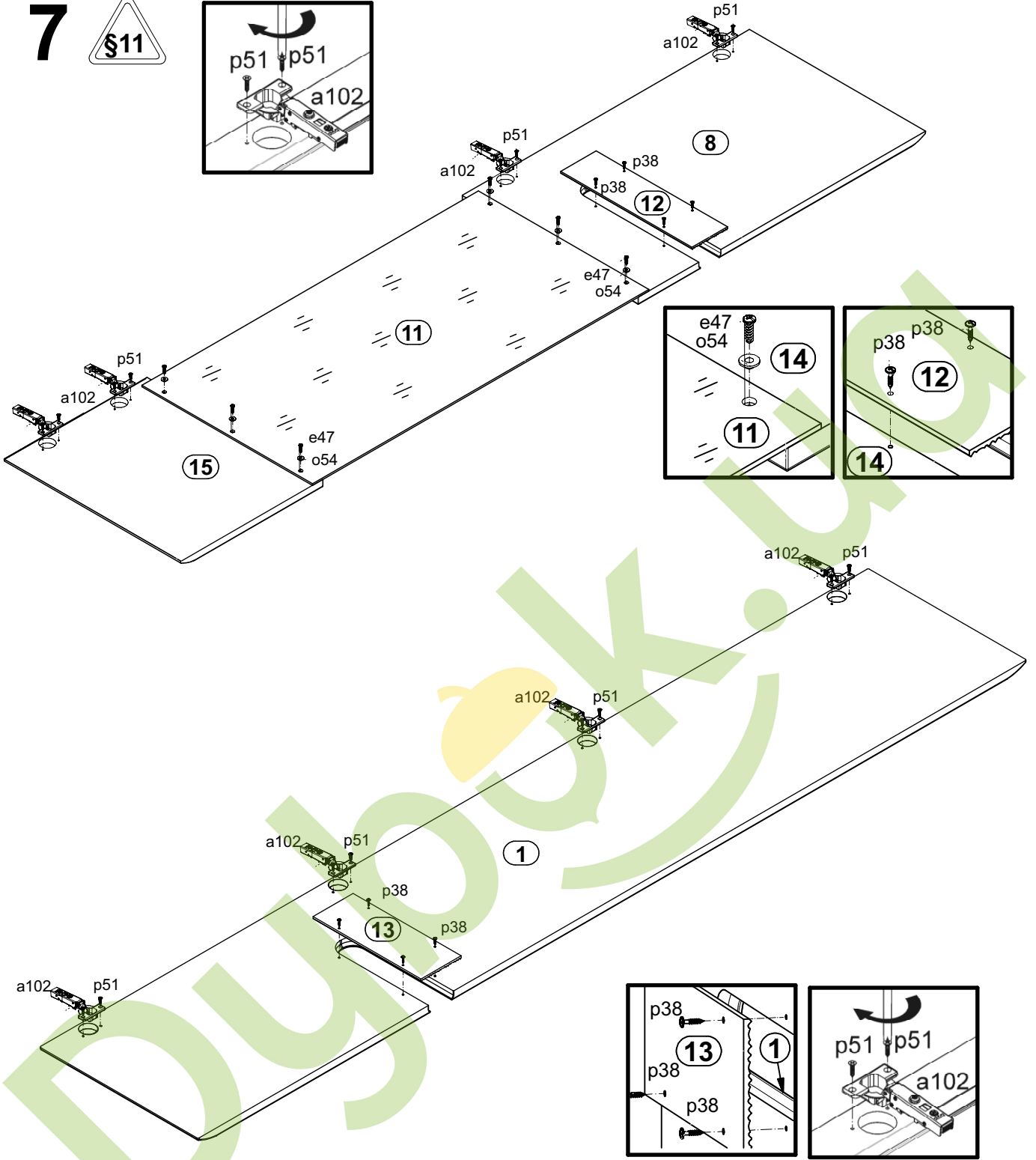
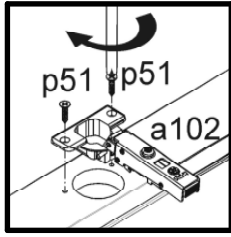

8

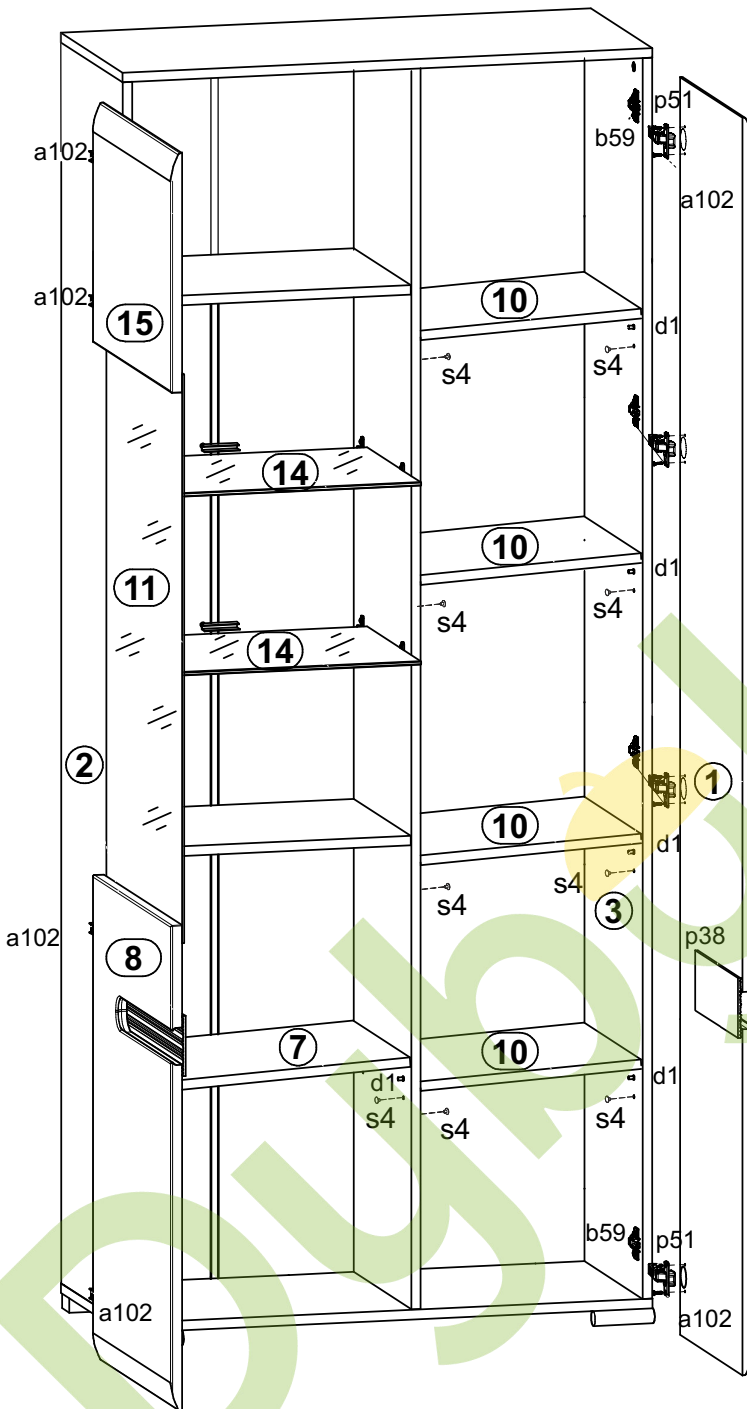

§23

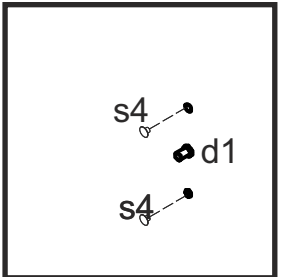
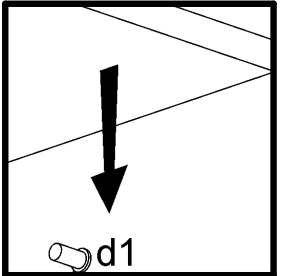
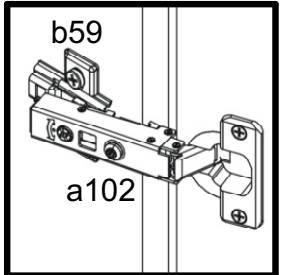
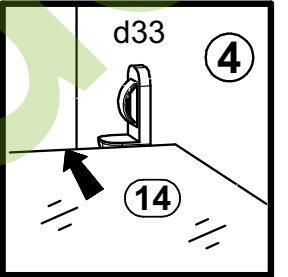
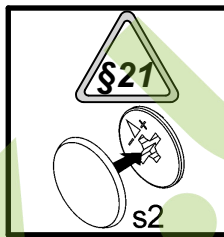
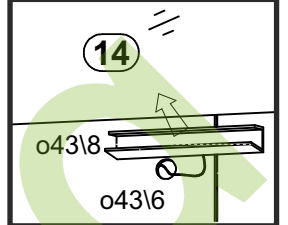
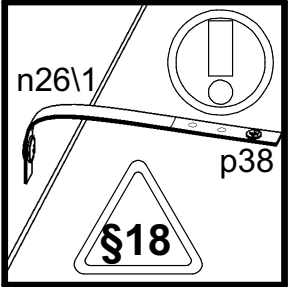
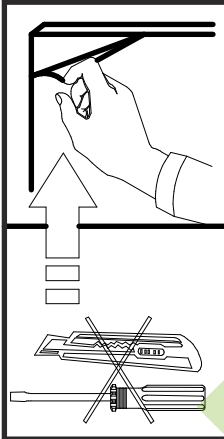

§10

