

АРИ; ЕСМЕРАЛЬДА АРИ; ЭСМЕРАЛЬДА

Шафа
Шкаф **SZF2D**

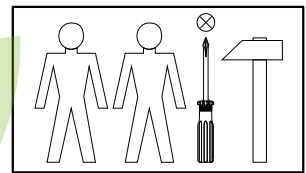

УВАГА! Після завершення монтажу фасадів білий (чорний) глянець **ЗНЯТИ ЗАХИСНУ ПЛІВКУ!**

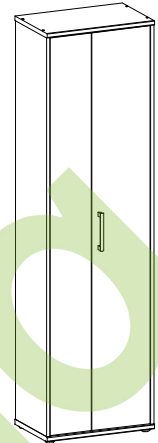
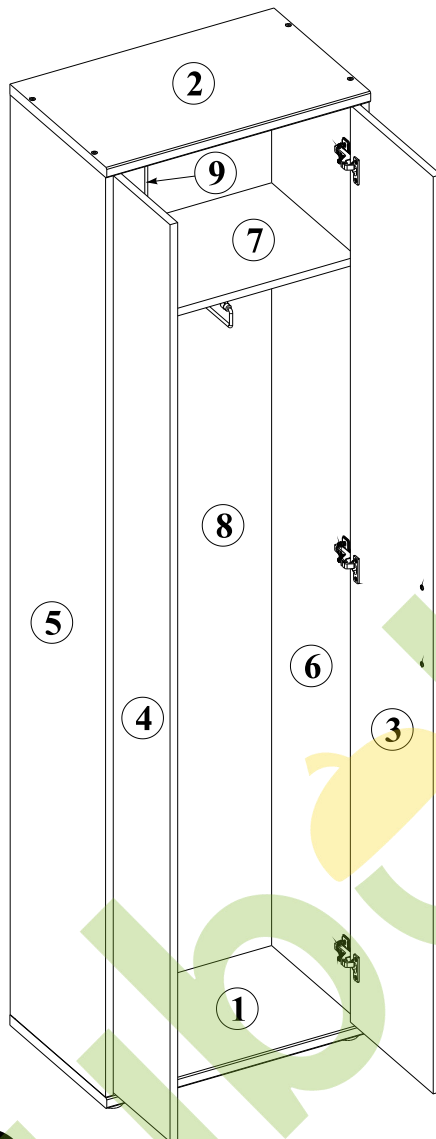





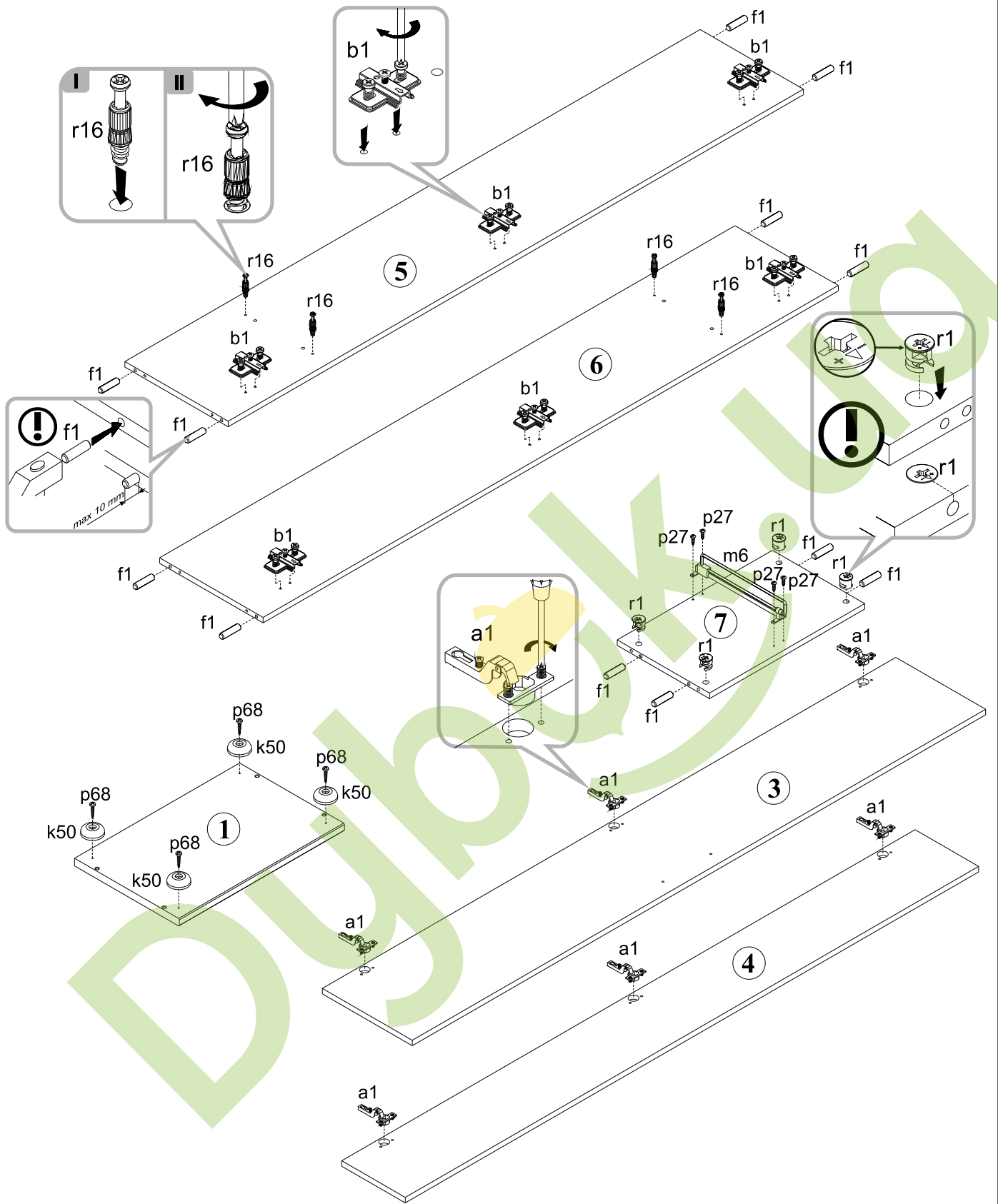

ВНИМАНИЕ! После завершения монтажа фасадов белый (черный) глянец **СНЯТЬ ЗАЩИТНУЮ ПЛЕНКУ!**

A	B	C	D
1	S19-258	551 x 350	1/1
2	S19-259	551 x 350	1/1
3	S19-057	1914 x 300	1/1
4	S19-058	1914 x 212	1/1
5	S19-1155	1920 x 345	1/1
6	S19-1156	1920 x 345	1/1
7	S19-3306	518 x 328	1/1
8	S19-984	1959 x 272	1/1
9	LH-1919	1919 x 14	1/1

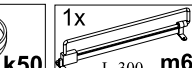
6x a1	6x b1	1x 160 mm c193	8x 7x50 mm e1	12x 8x30 mm f1	 1x 3.5x16 mm p38 1x n26
4x k50	55x l1	1x L-300 m6	2x 4x30 mm p9	4x 3.5x13 mm p27	
4x 4x20 mm p68	4x 15x12mm #16 r1	4x r16	4x 16 s2	1x z1	

1



6x  b1	6x  a1	4x  k50	1x  L-300 m6	4x  φ3,5x13 mm p27	12x  φ8x30 mm f1	4x  φ15x12mm #16 r1	4x  r16	4x  φ4x20 mm p68
--	--	---	--	--	--	--	---	--

2

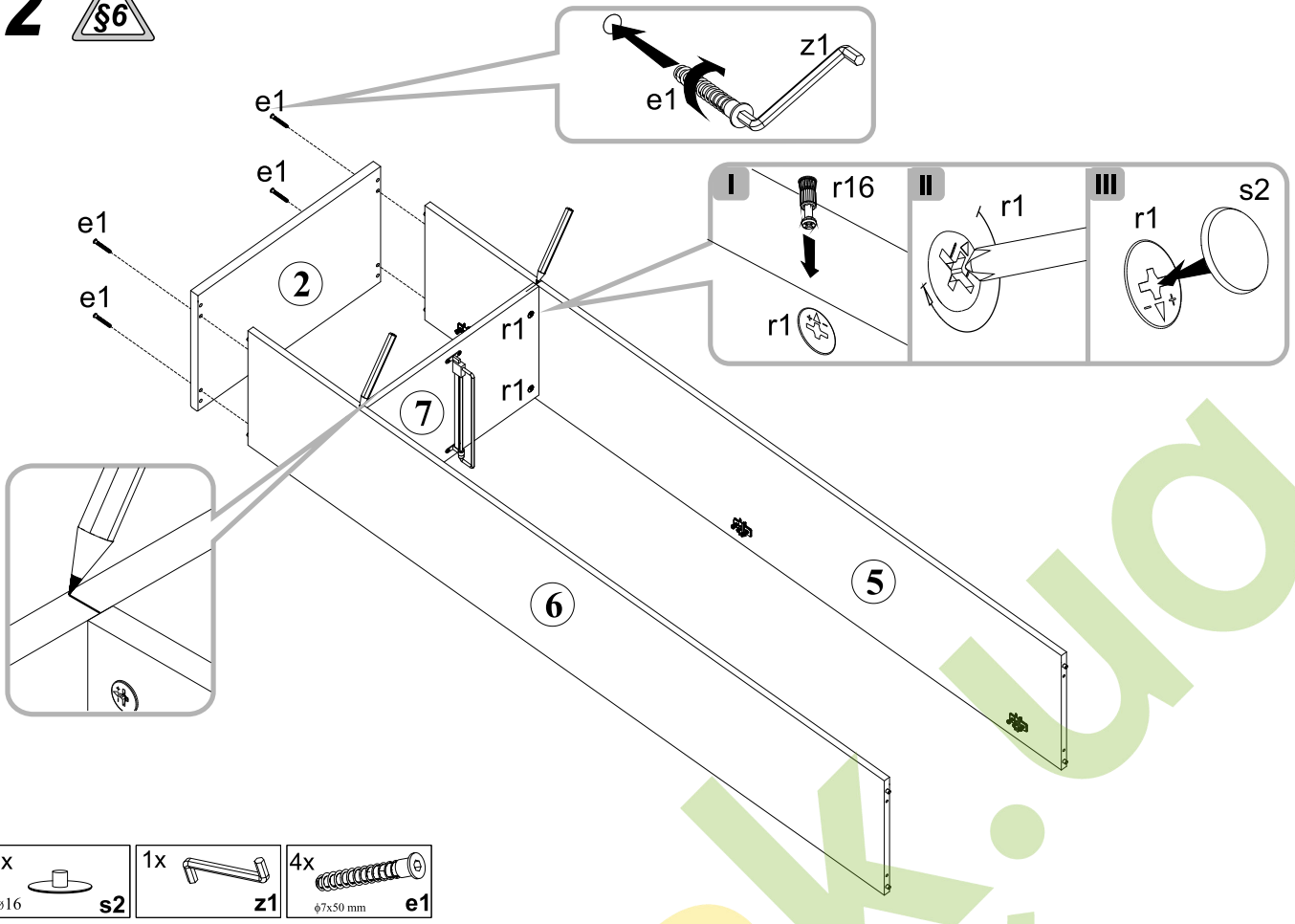

- 4x s2
- 1x z1
- 4x e1 $\phi 7 \times 50 \text{ mm}$

3

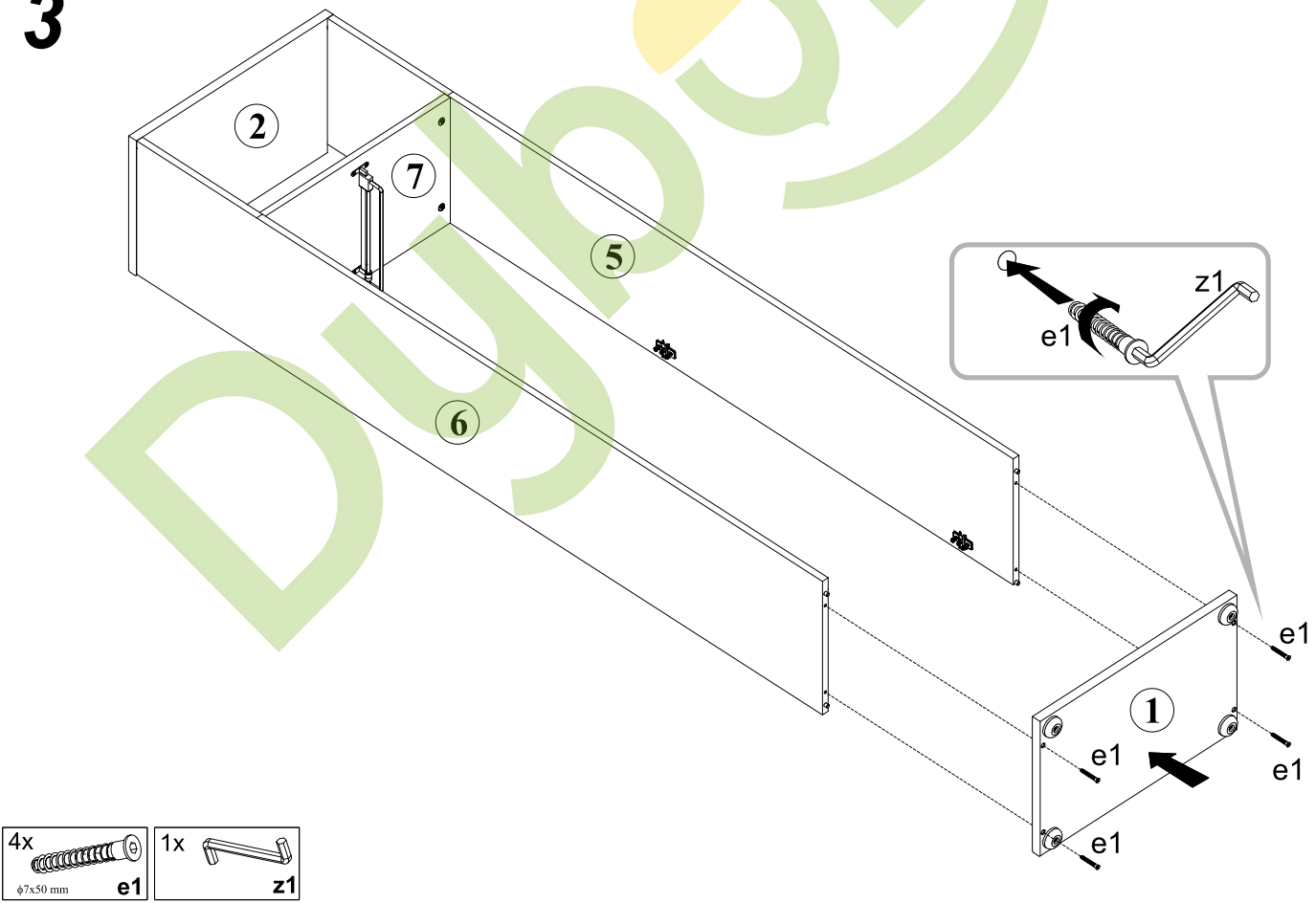

- 4x e1 $\phi 7 \times 50 \text{ mm}$
- 1x z1

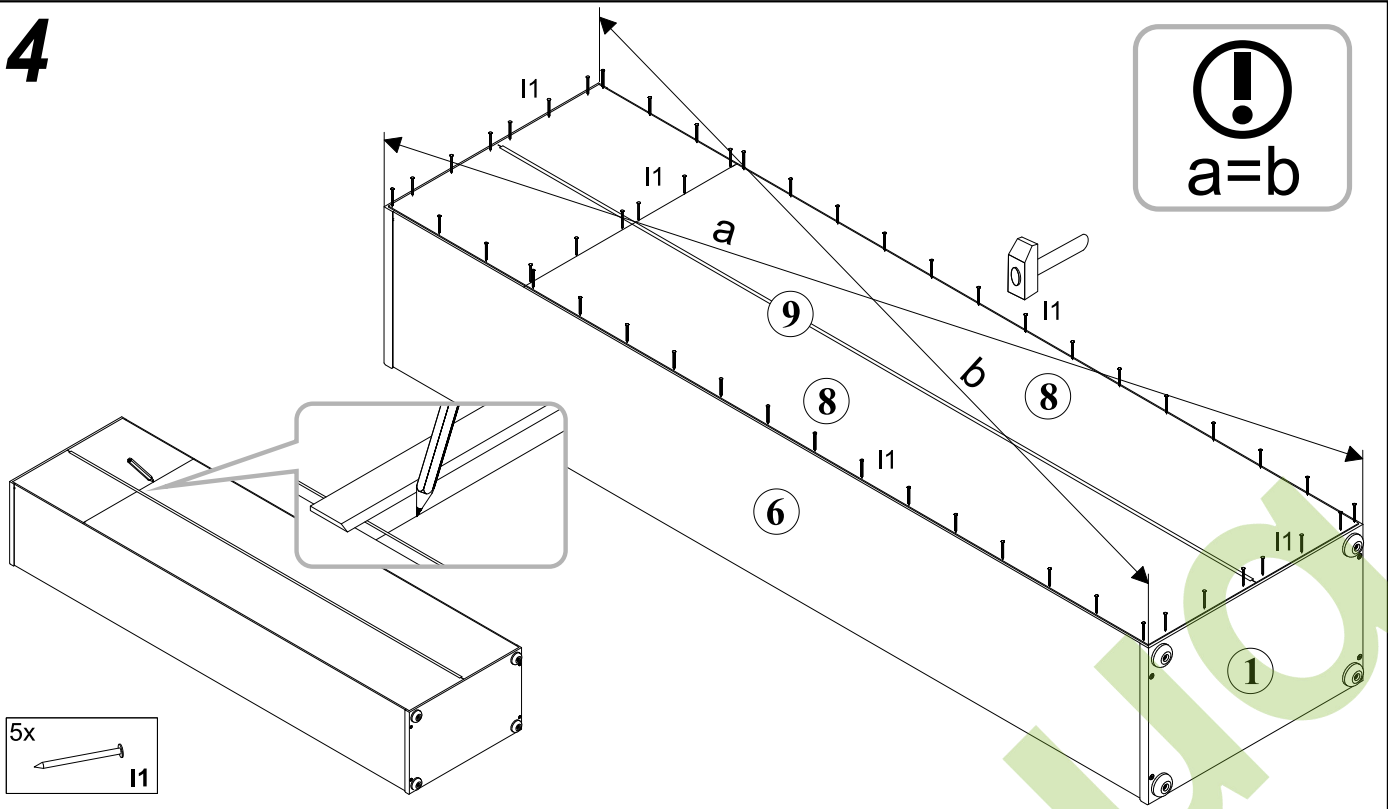
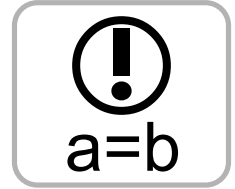
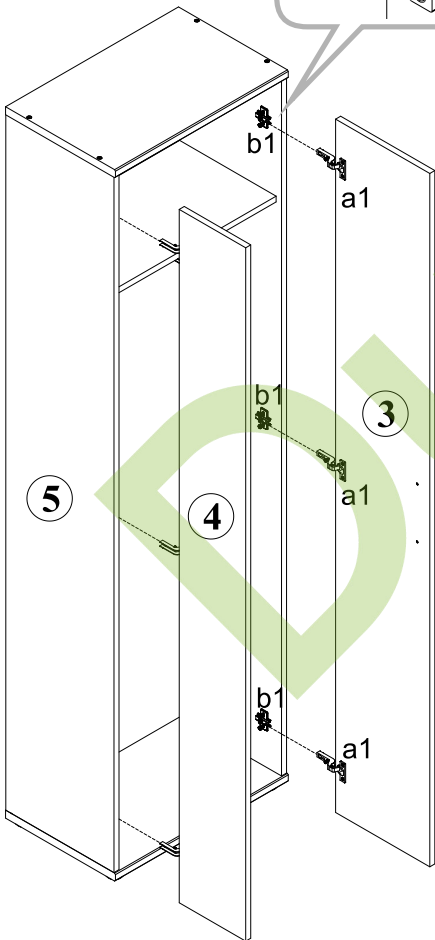
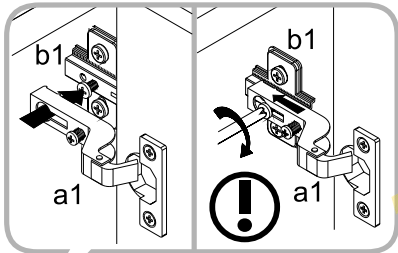
4**5****6**