

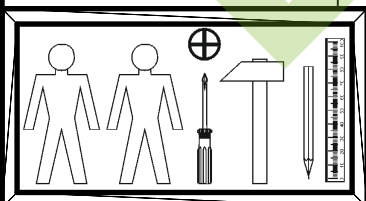

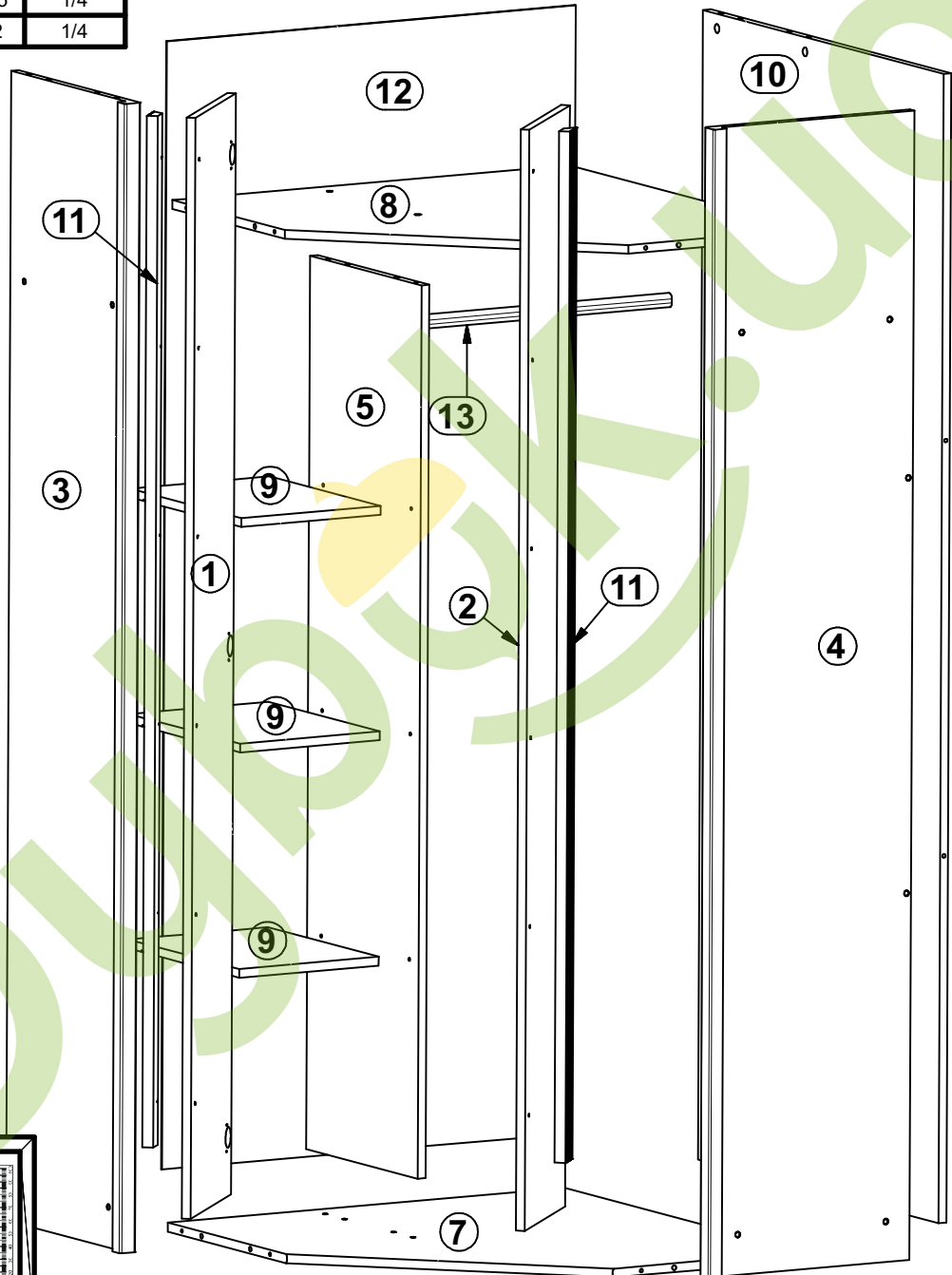

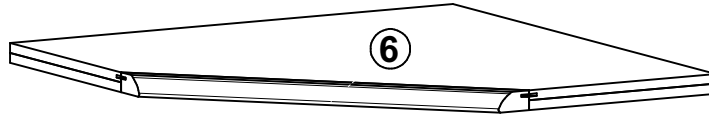

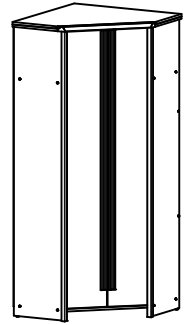



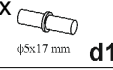
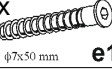

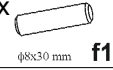
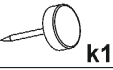
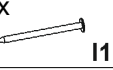
CAPS

S153-SZFN2D

A	B	C	D	
1	S153-0017	1866	275	2/4
2	S153-0018	1866	275	2/4
3	S153-1126	1948	399	1/4
4	S153-1127	1948	400	1/4
5	S153-1130	1514	365	2/4
6	S153-2207	820	820	3/4
7	S153-3320	770	787	3/4
8	S153-3321	770	787	3/4
9	S153-3326	271	364	2/4
10	S153-4405	1948	787	1/4
11	S153-577	1748	49	4/4
12	S153-9912	1912	795	1/4
13	dr-480	480	22	1/4



6x  a14	6x  b7	12x  φ5x17 mm d1	18x  φ7x50 mm e1	12x  φ6x13 mm e3	22x  φ8x30 mm f1	6x  k1	80x  l1	2x  n1
8x  φ3,5x13 mm p1	12x  φ3,5x15 mm p51	12x  φ4x22 mm p60	6x  φ1,5x12mm #16 r1	6x  r42	1x  z1	16x  s1	6x  ø16 s2	

1 

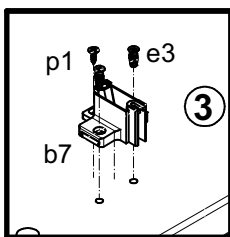
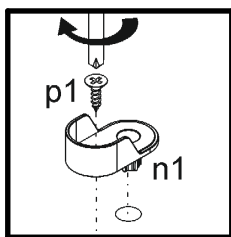
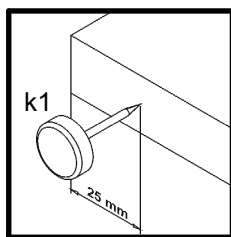
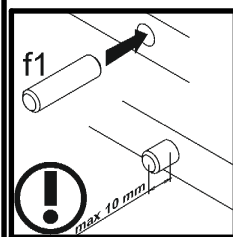
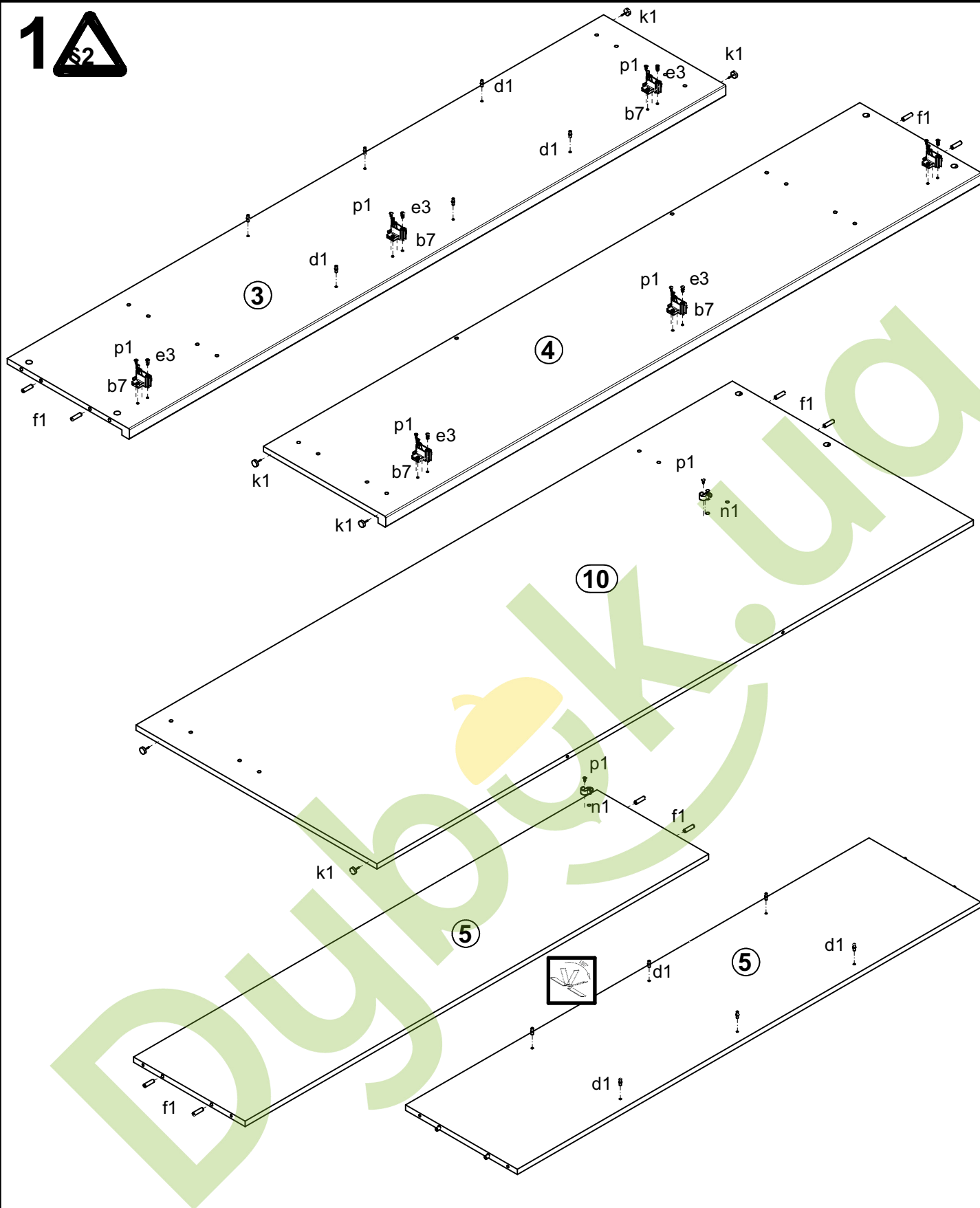

2 

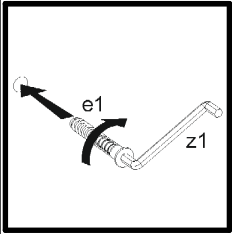
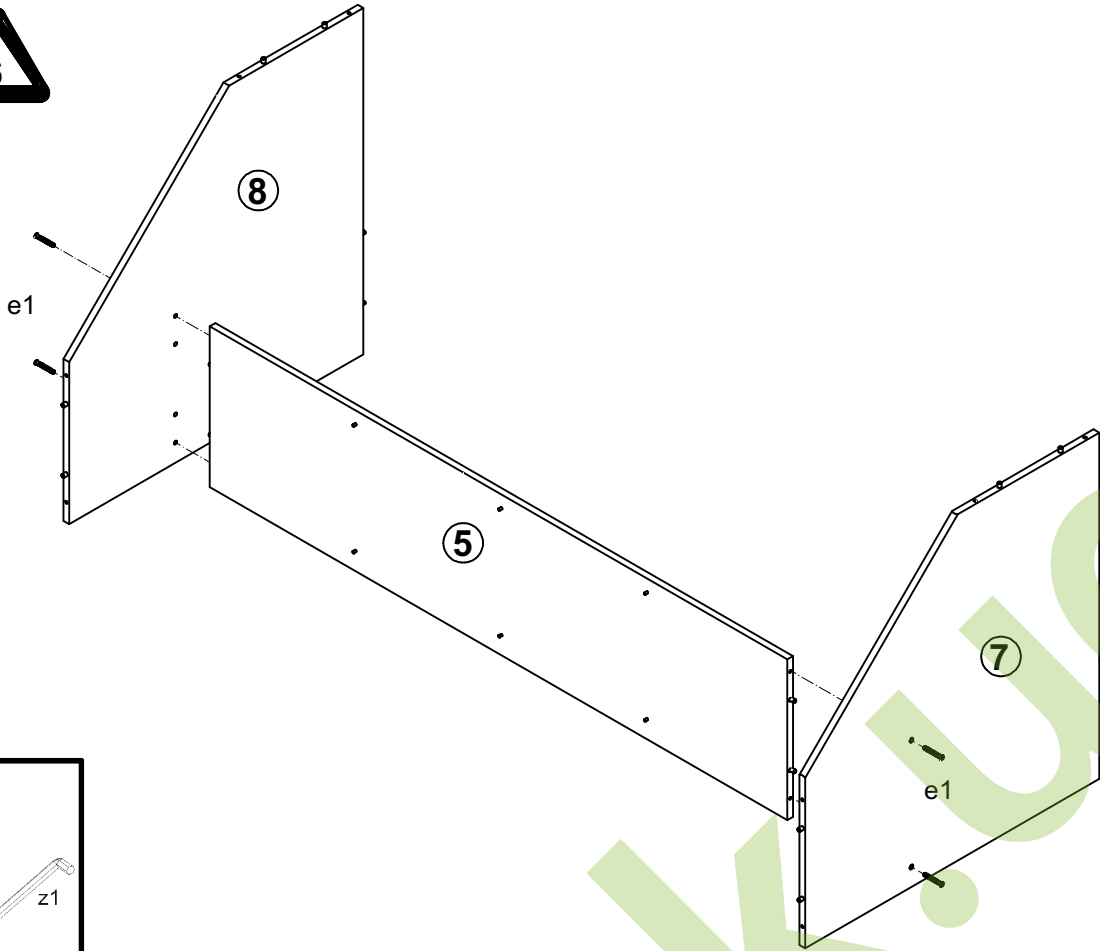

3

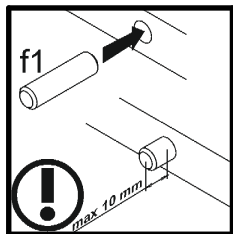
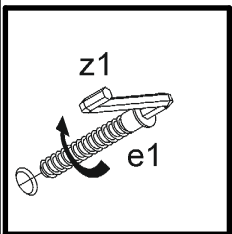
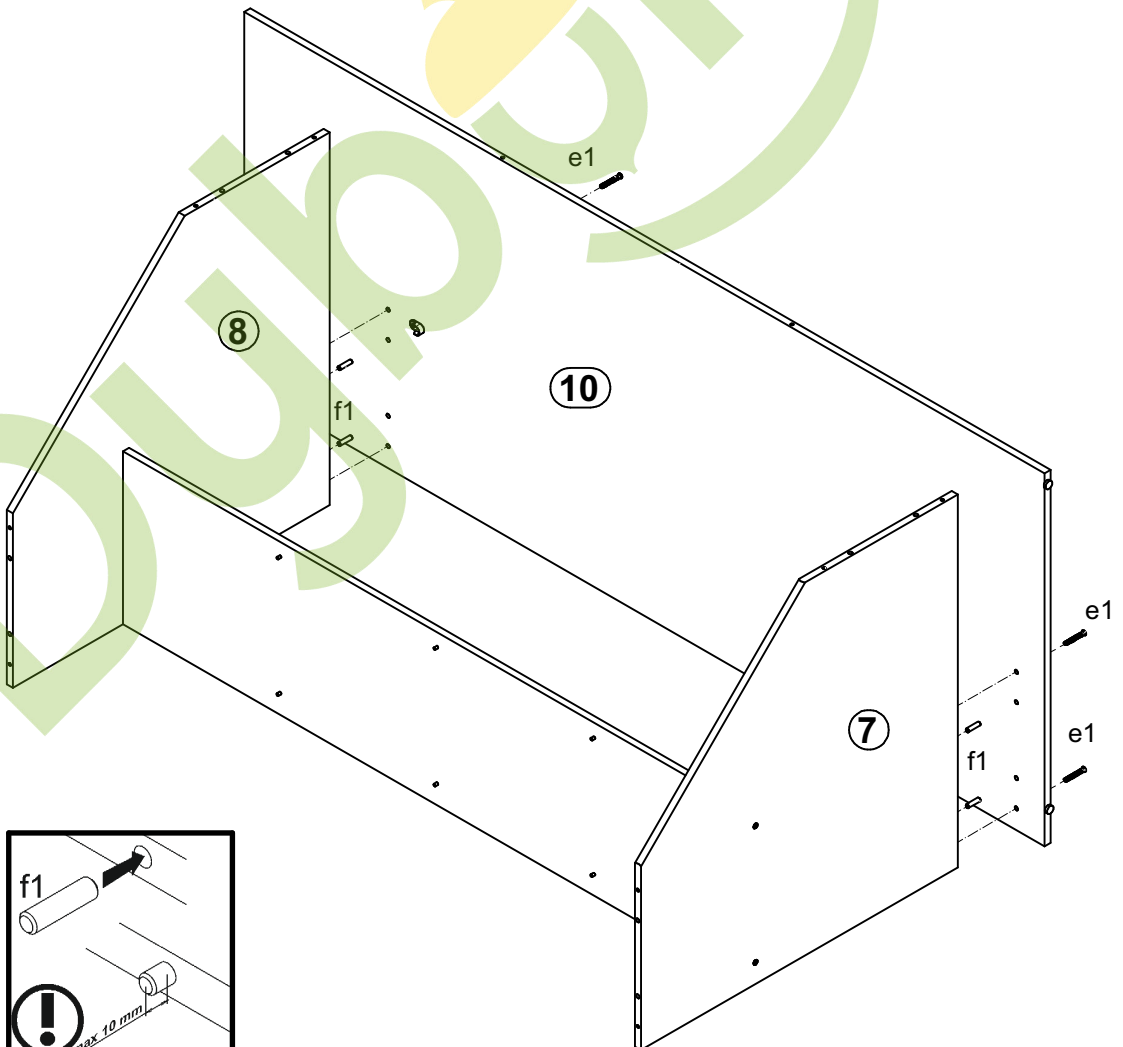

3

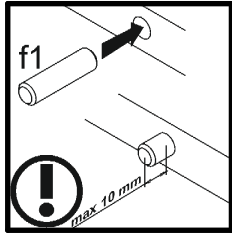
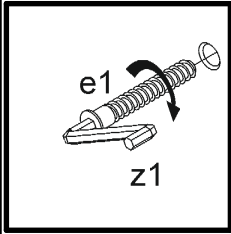
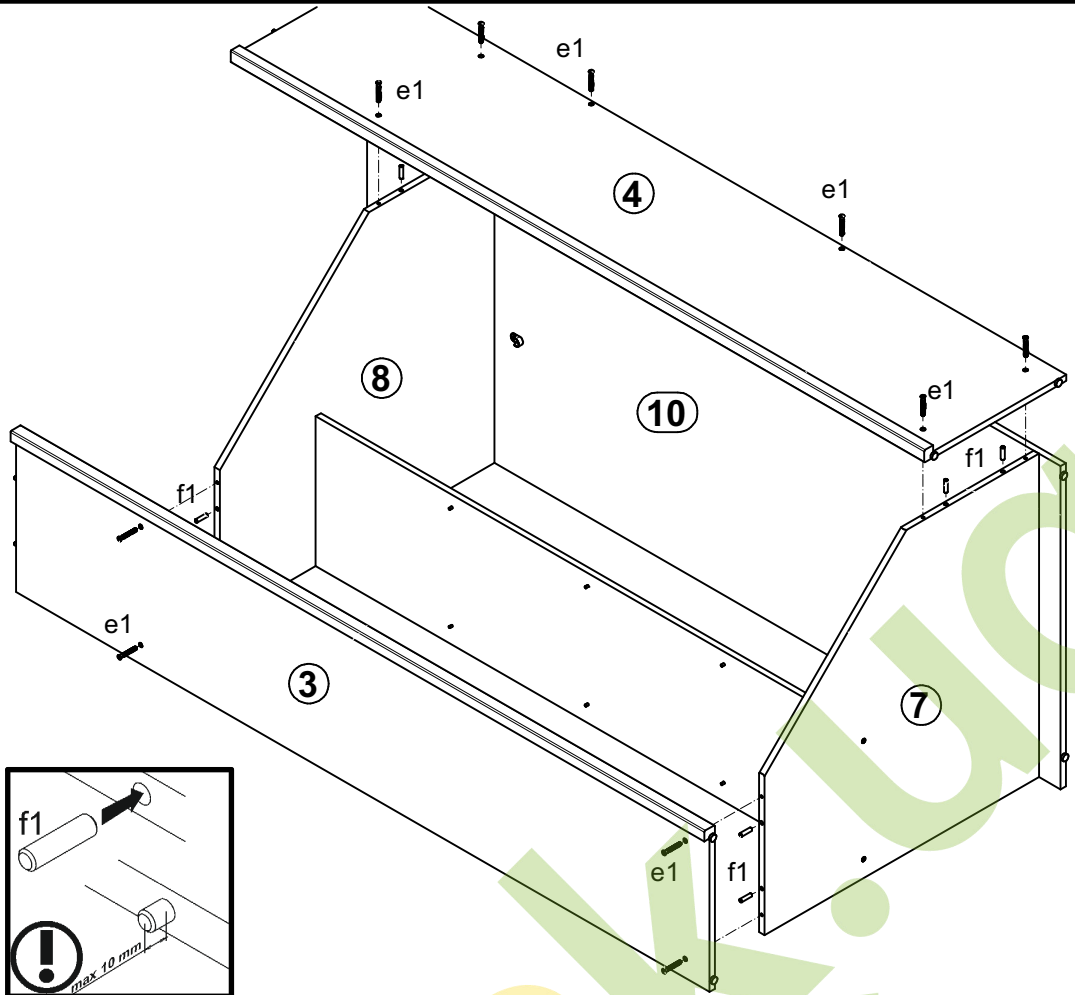

4

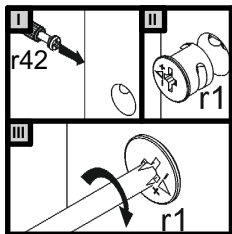
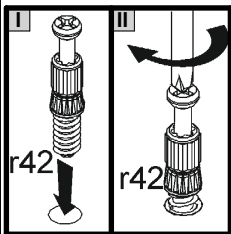
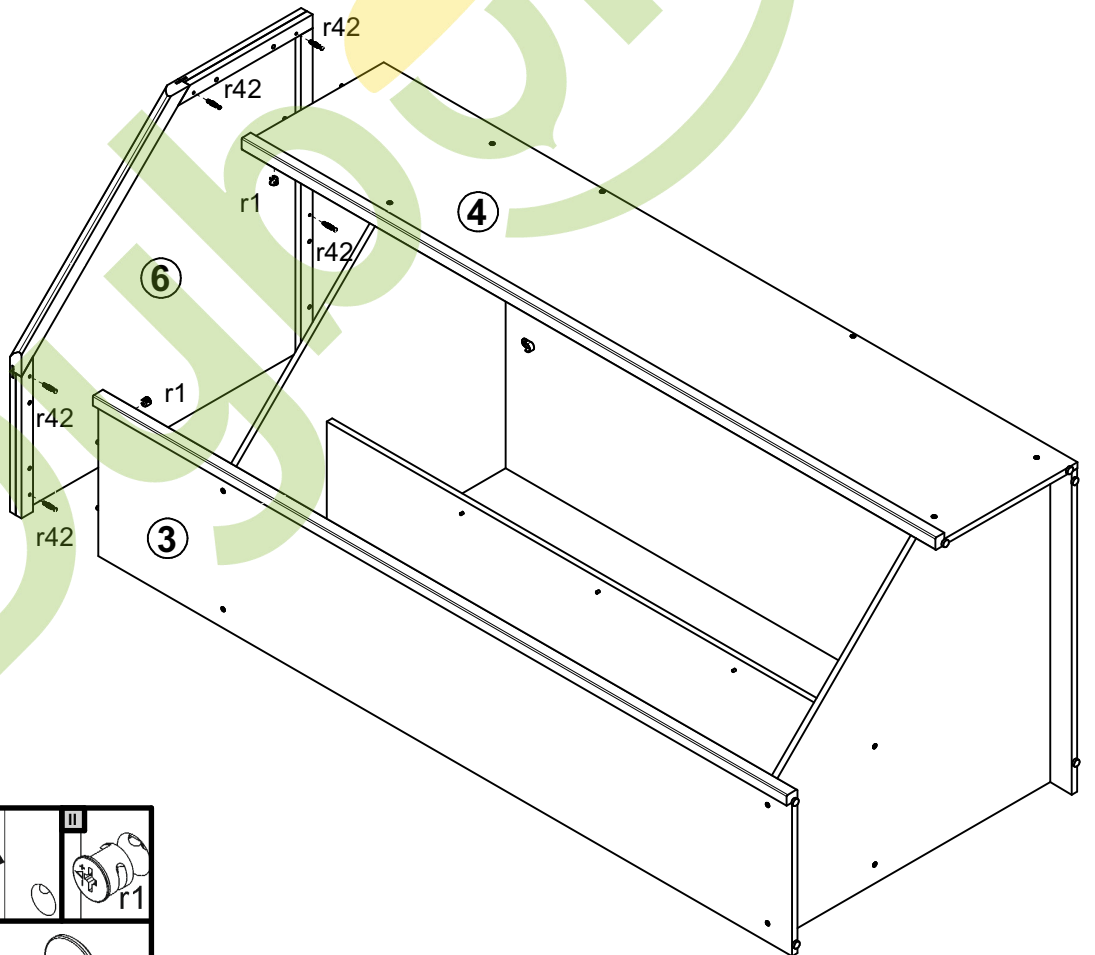

5

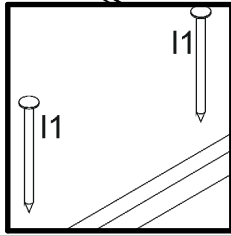
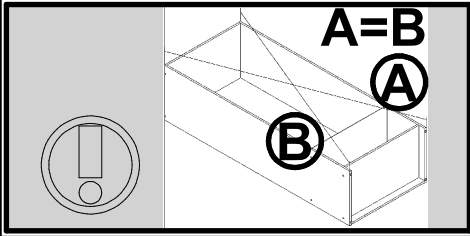
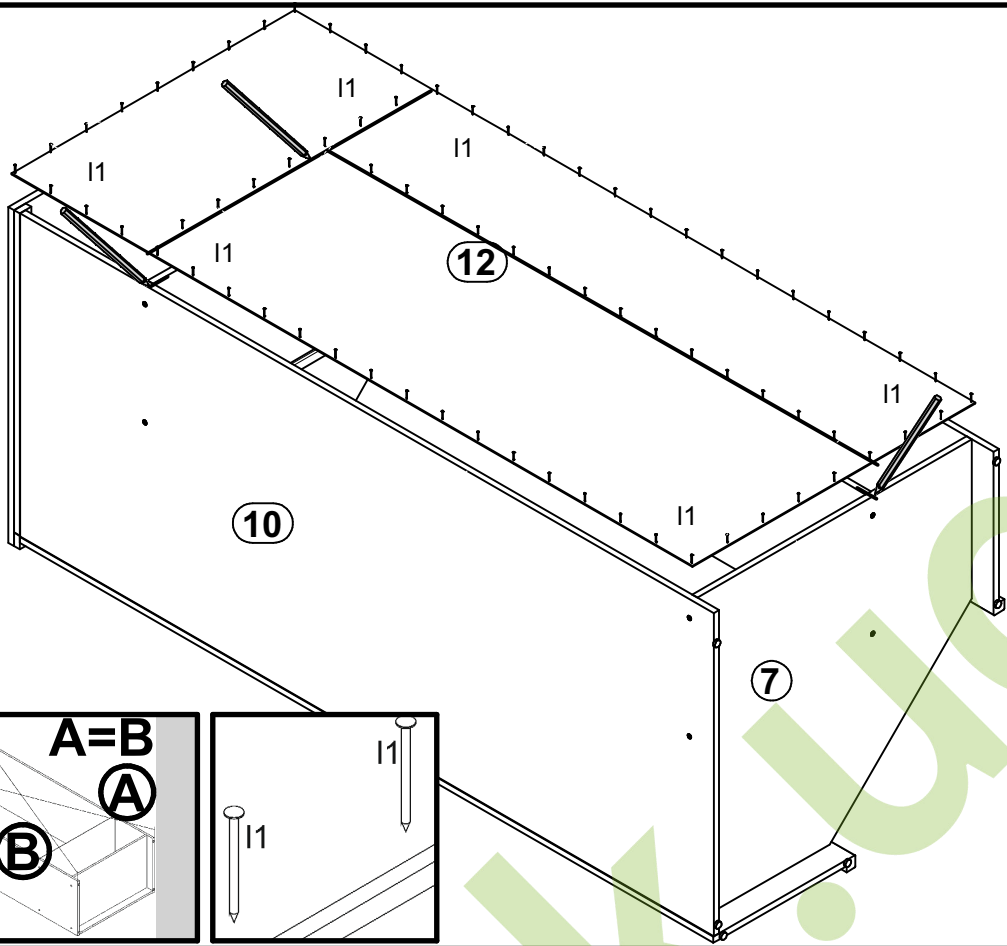
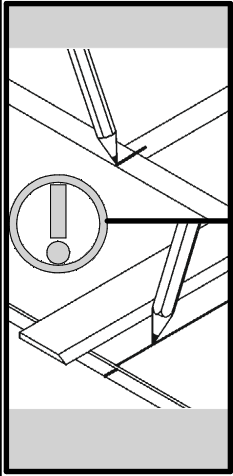

6

