

LOREN

S163-KOM2D3S

A	B	C	D	A	B	C	D		
1	S163-0004	436	196	3/3	11	S163-4406	1352	60	2/3
2	S163-0005	628	436	3/3	12	S163-4407	1388	60	2/3
3	S163-0006	628	436	3/3	13	S163-4408	430	60	2/3
4	S163-1107	860	400	1/3	14	S163-504	1352	64	2/3
5	S163-1108	860	400	1/3	15	S163-91903	717	222	1/3
6	S163-1109	689	359	2/3	16	S163-9906	403	355	1/3
7	S163-1110	689	359	2/3	17	S163-91904	717	243	1/3
8	S163-3305	1388	359	2/3	19	ZS4-501	350	120	1/3
9	S163-3306	1352	360	2/3	20	ZS4-502	350	120	1/3
10	S163-3307	462	333	2/3	18	ZS3-5513	381	120	1/3
					21	Lh-687	687	14	1/3

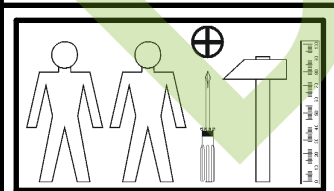
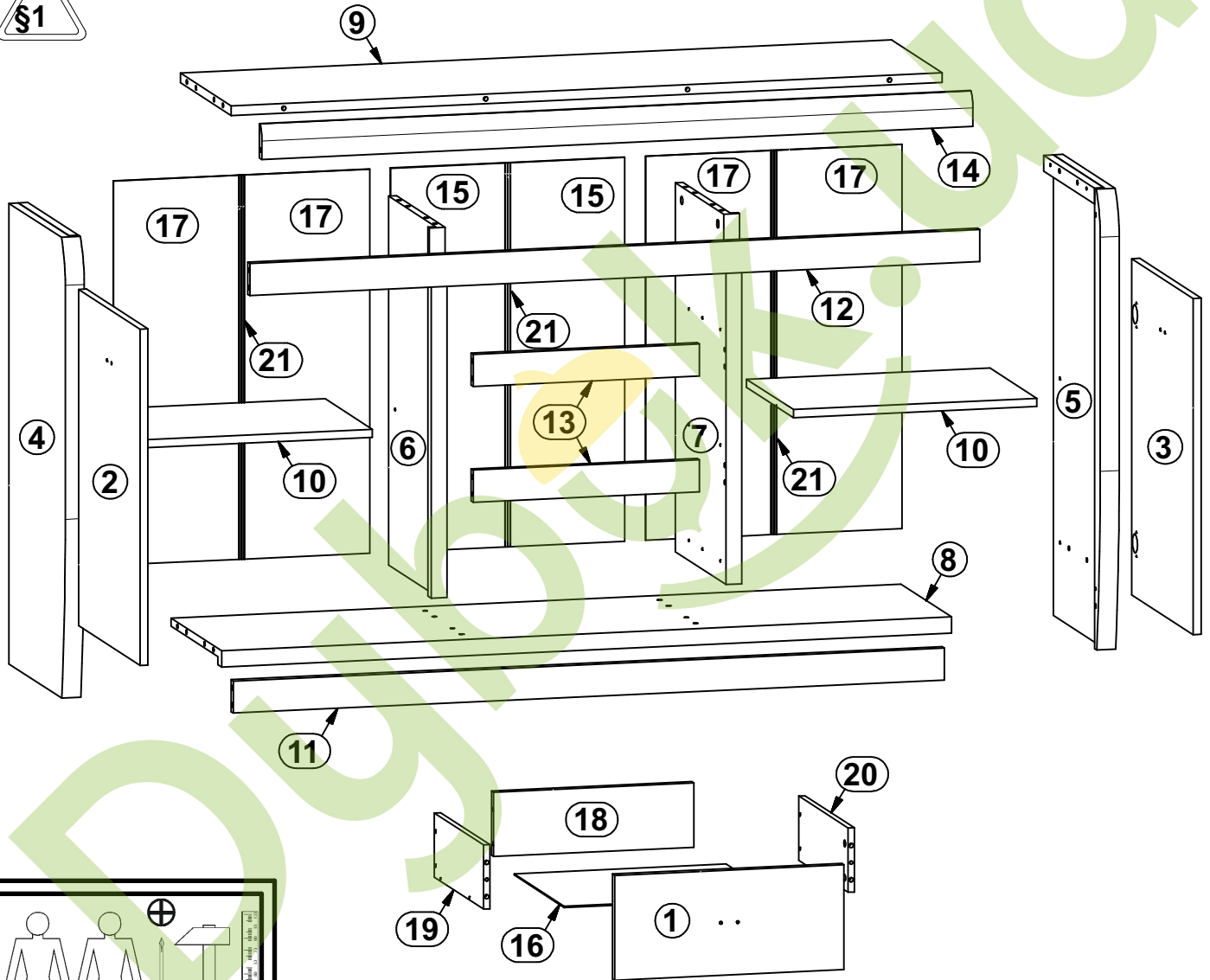
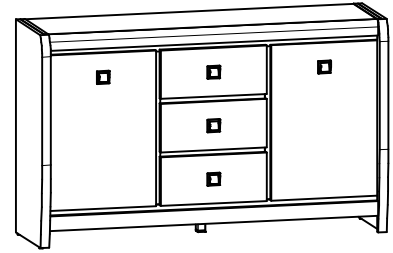

4x a43	4x b18	5x c333	8x d1 5x17 mm	4x e1 17x50 mm	12x e19 16x9 mm	9x e2 16x3x13 mm	18x e3 16x13 mm	32x f1 16x30 mm
6x f9 16x30 mm	12x f25 16x5x40 mm	10x j1 M4x20 mm	4x k1	1x k38/3	1x k38/5	80x l1	1x n56 32x16x15/1 mm	2x p27 16x5x13 mm
16x p38 16x5x16 mm	8x p51 16x5x15 mm	18x r1 16x5x12 mm #16	12x r15 16x12x10.5 mm #12	30x r16	3x w45/CL 350 mm	3x w45/CR 350 mm	3x w45/DL 350 mm	3x w45/DR 350 mm
1x z1	1x n26/1 16x5x16 mm	1x p38 16x5x16 mm						

1

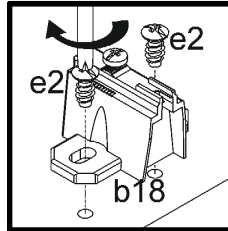
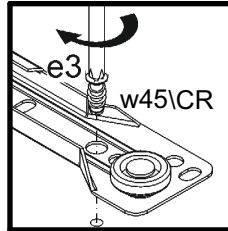
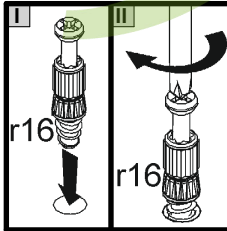
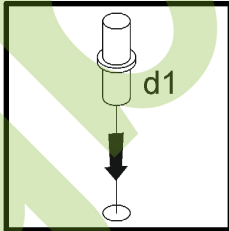
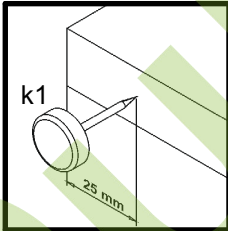
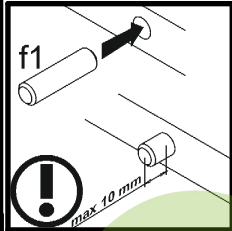
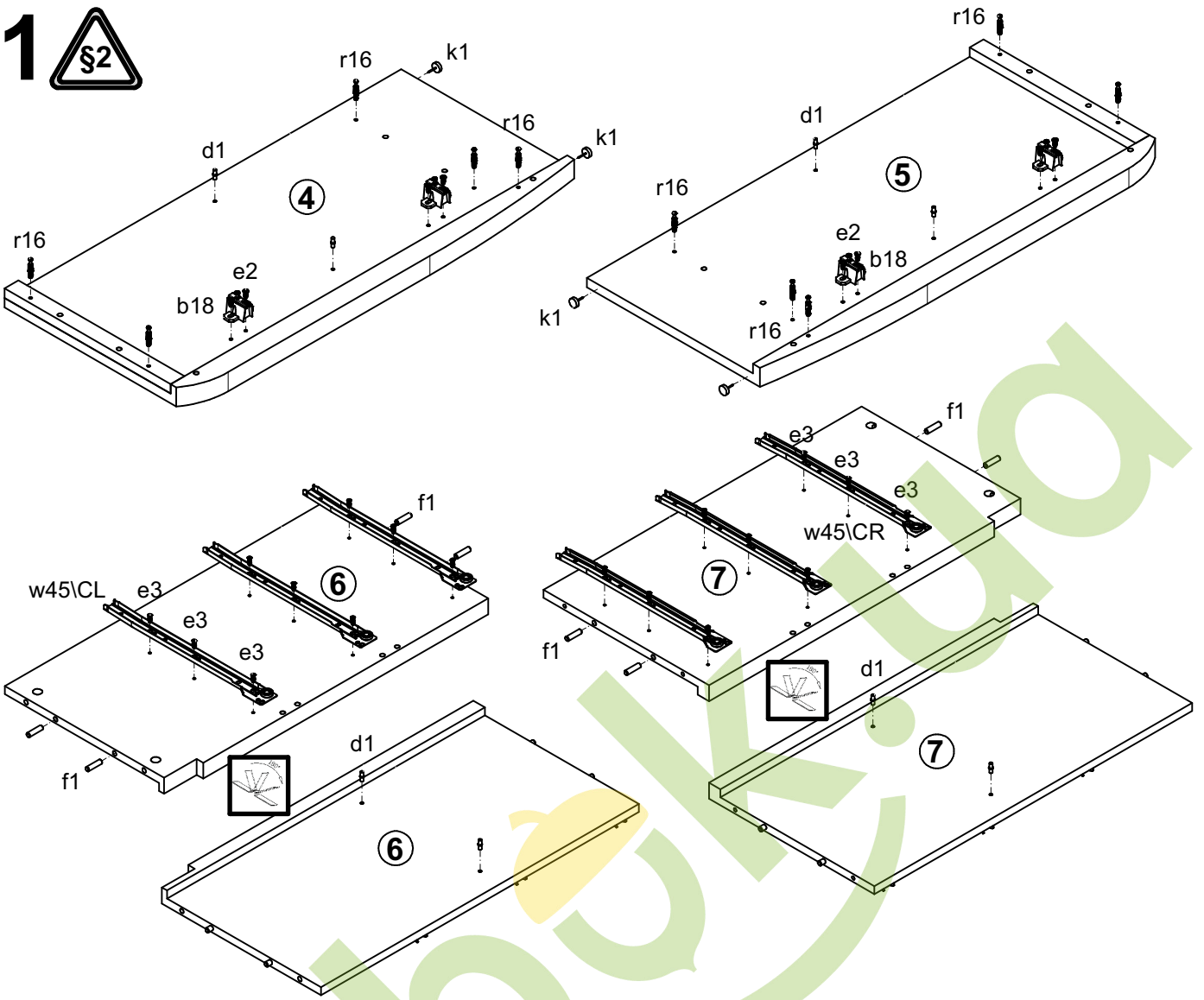

2

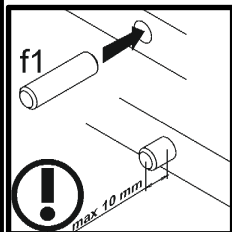
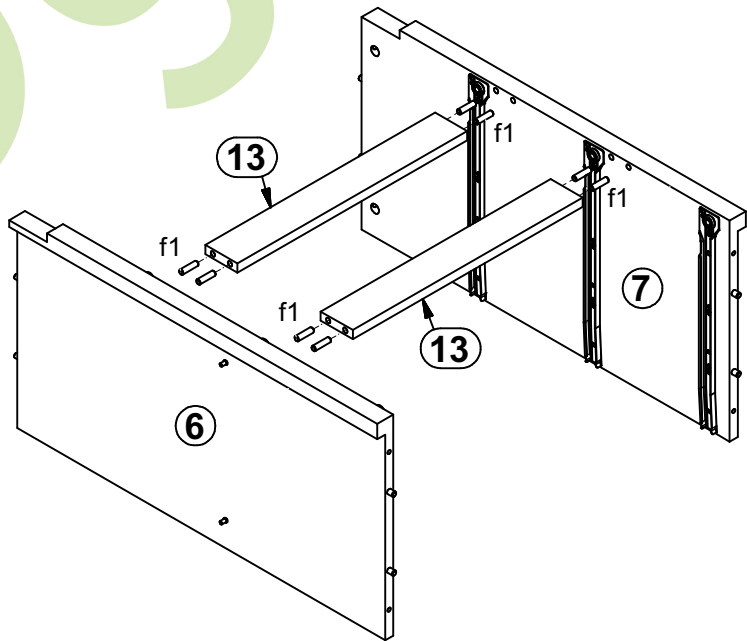

3

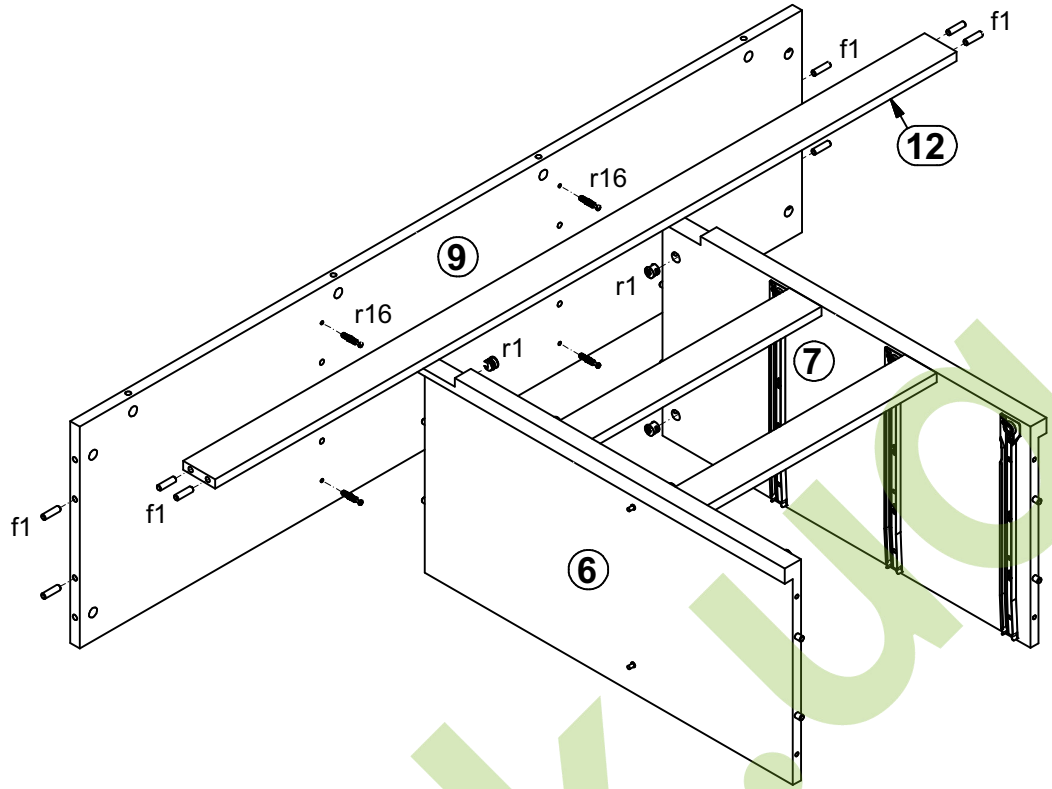
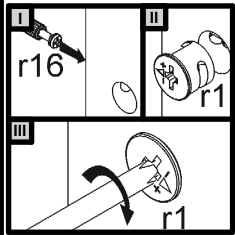
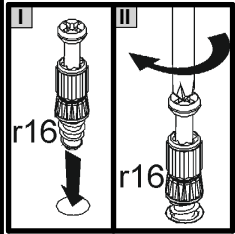
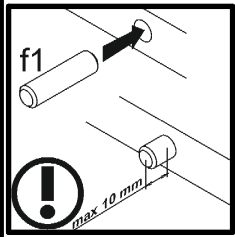

4

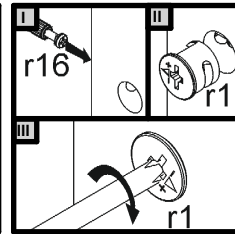
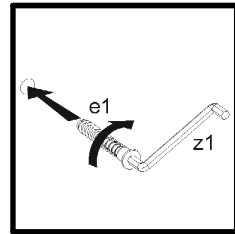
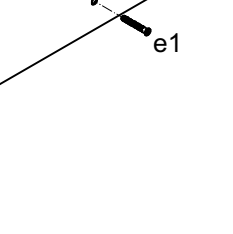
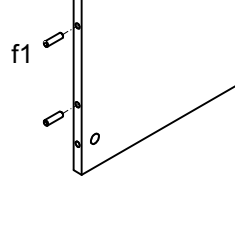
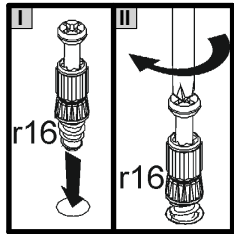
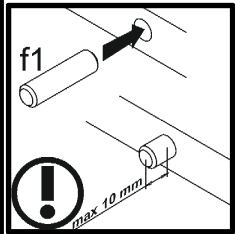
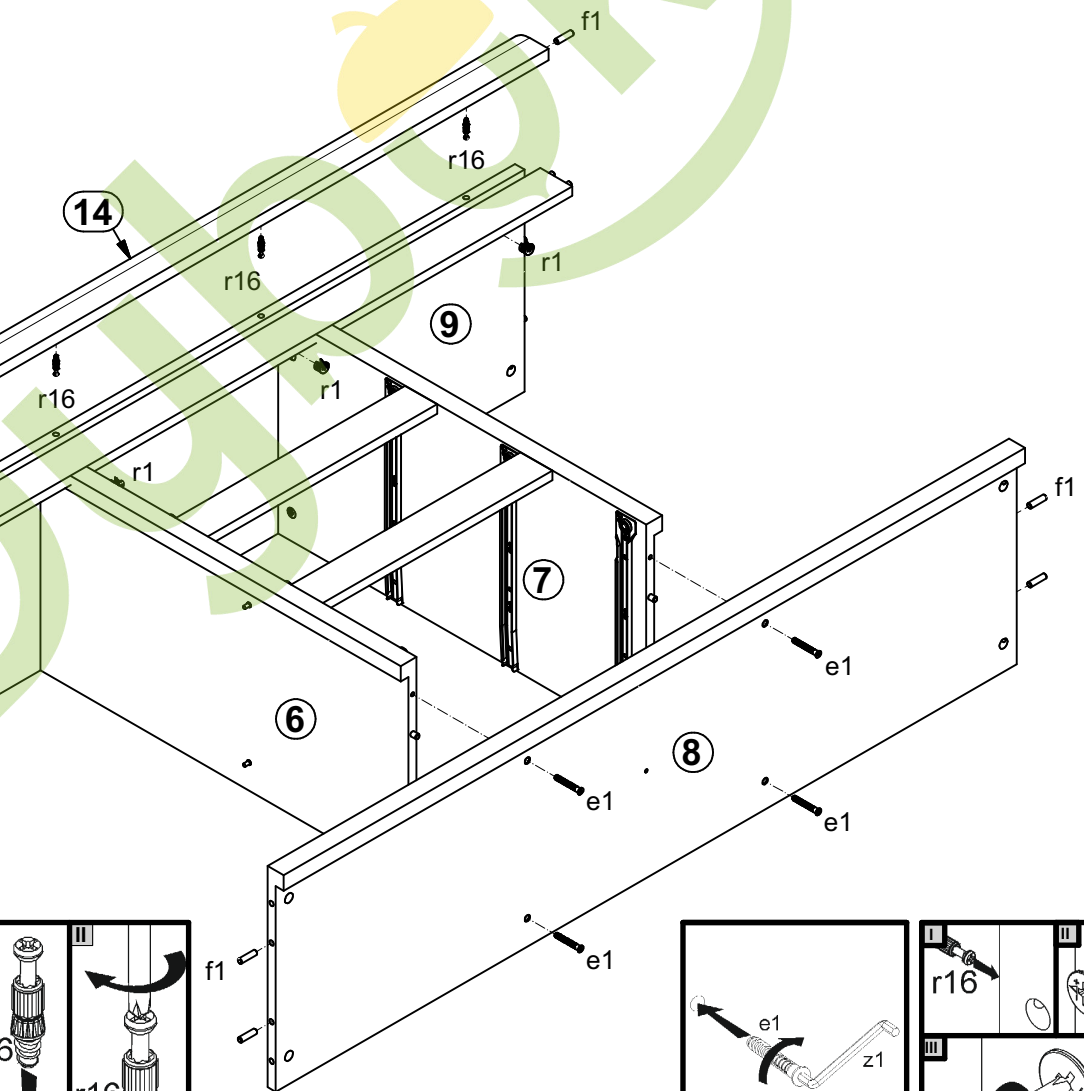
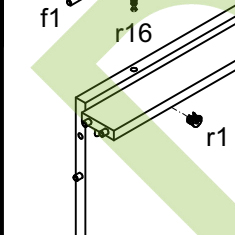
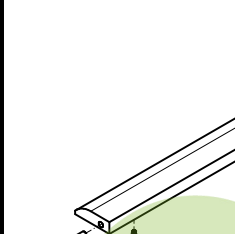
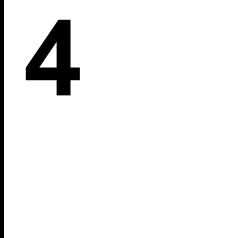

5

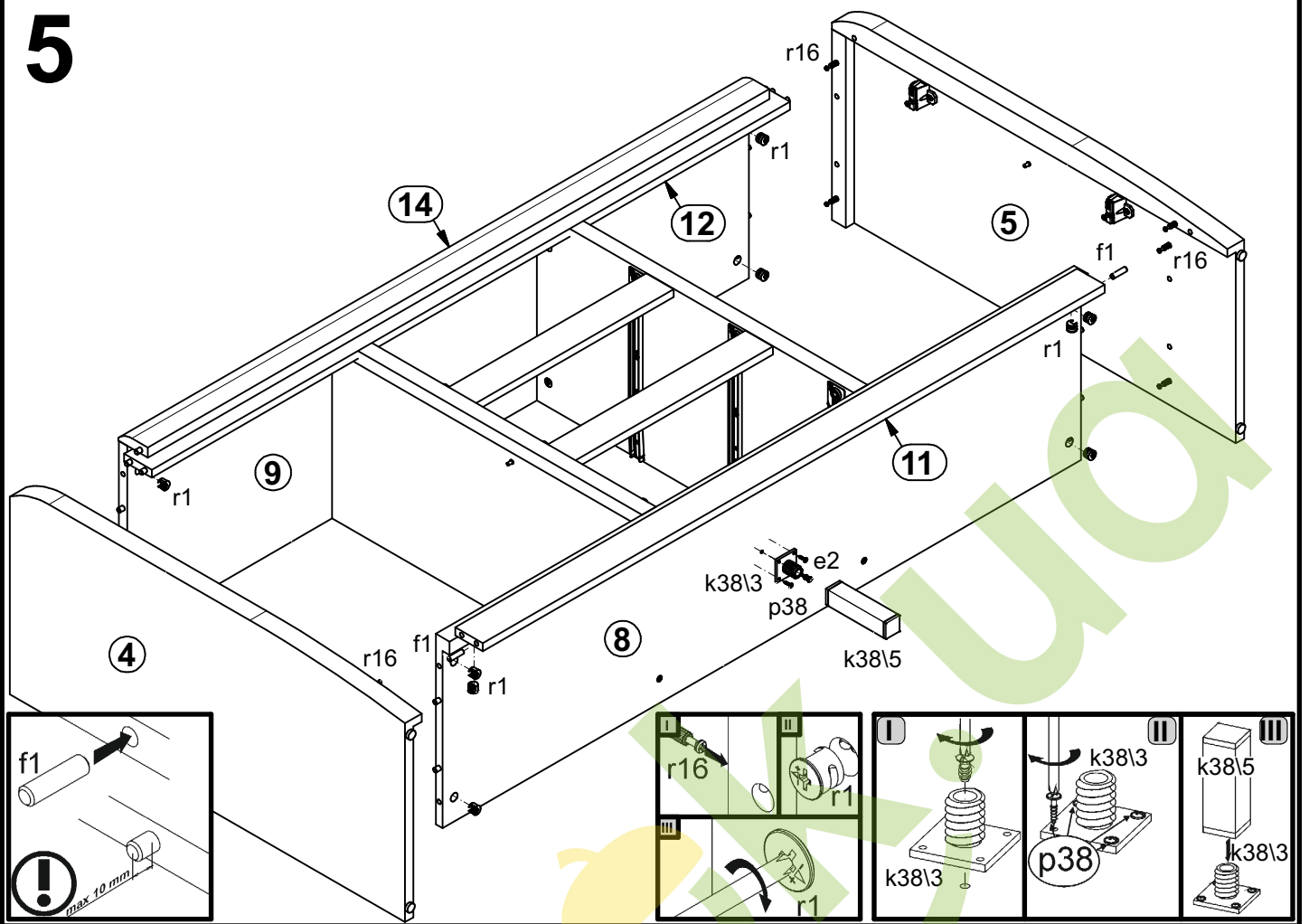

6

