

A	B	C (mm)		D
1	S174-312A	1199	230	1/1
2	S174-401A	1200	150	1/1

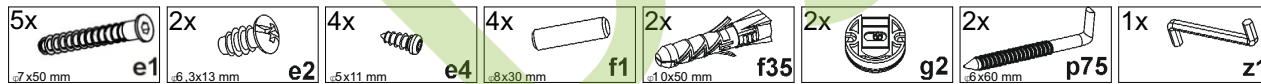

1 §2

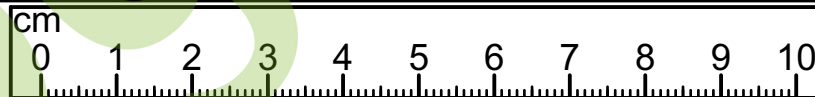
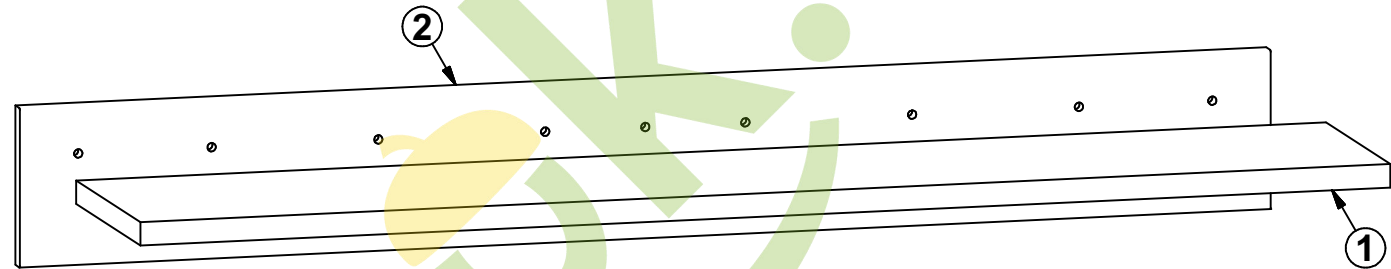
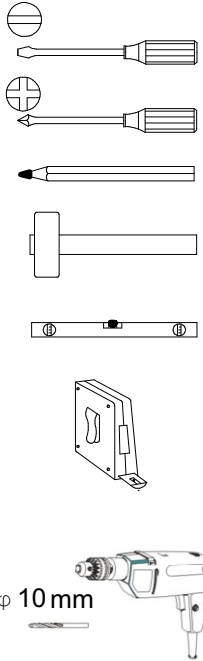
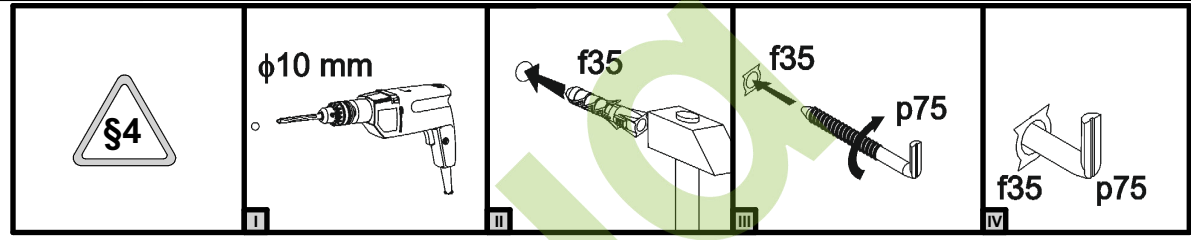
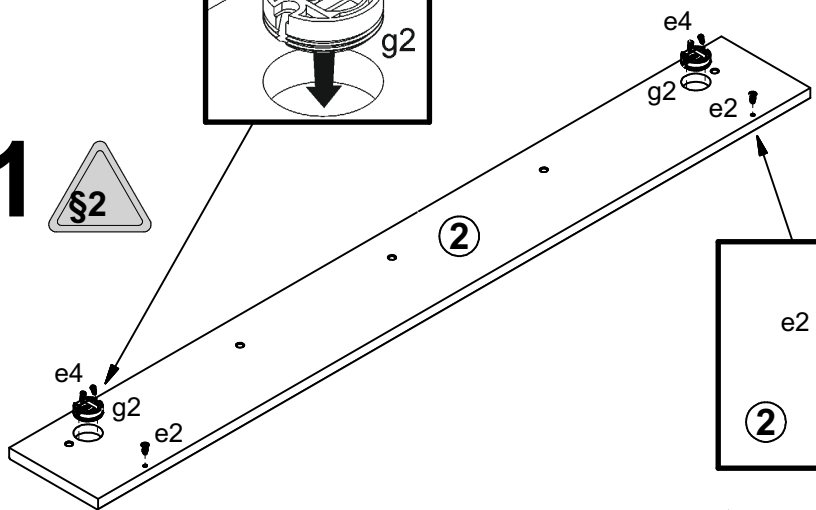
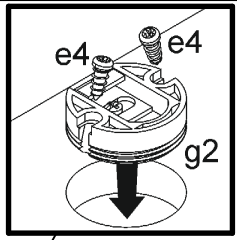

3

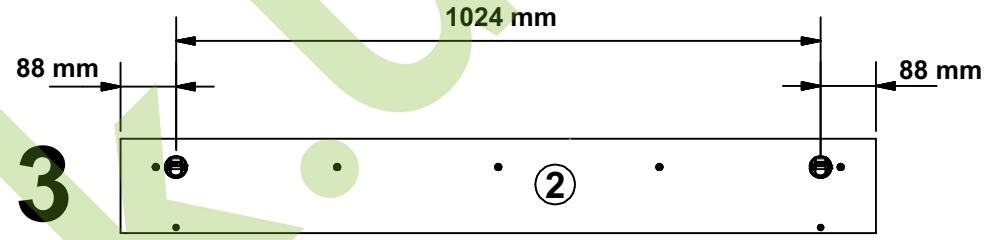

2 §6

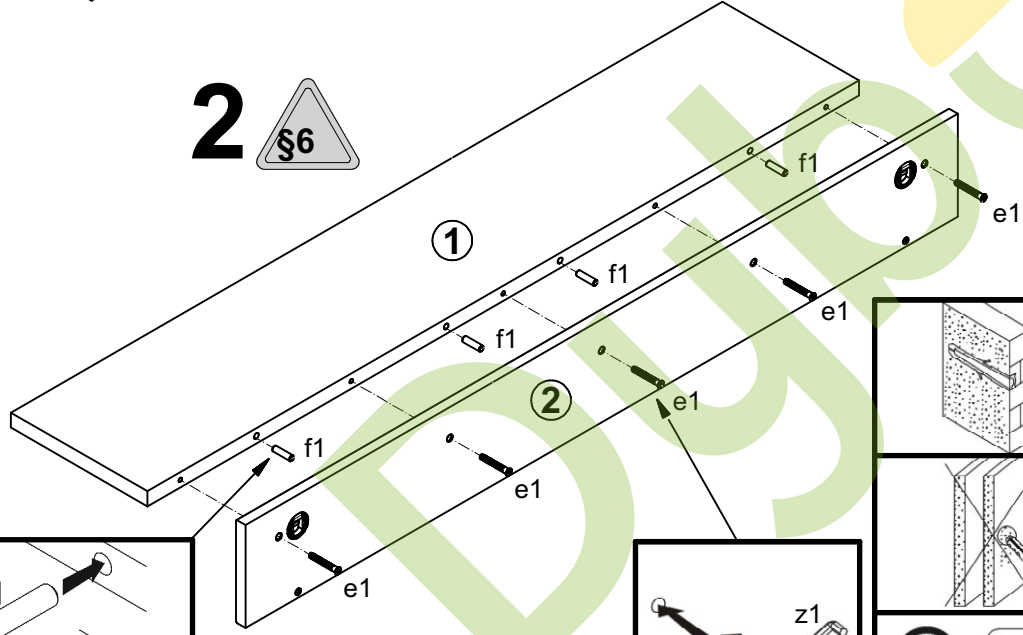

4

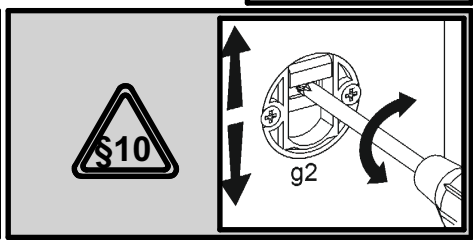
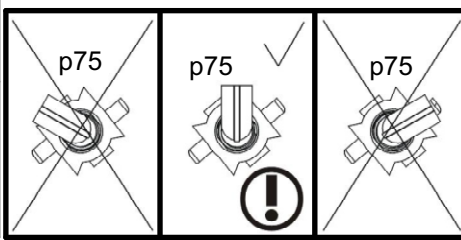
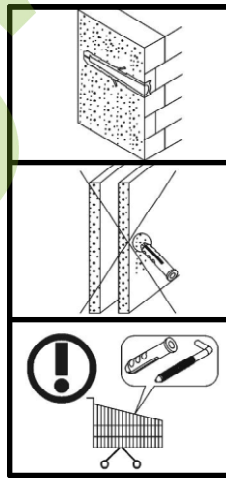
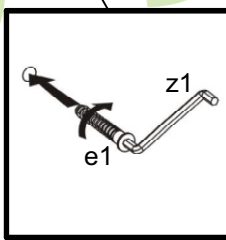
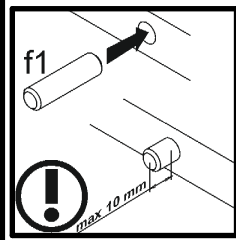
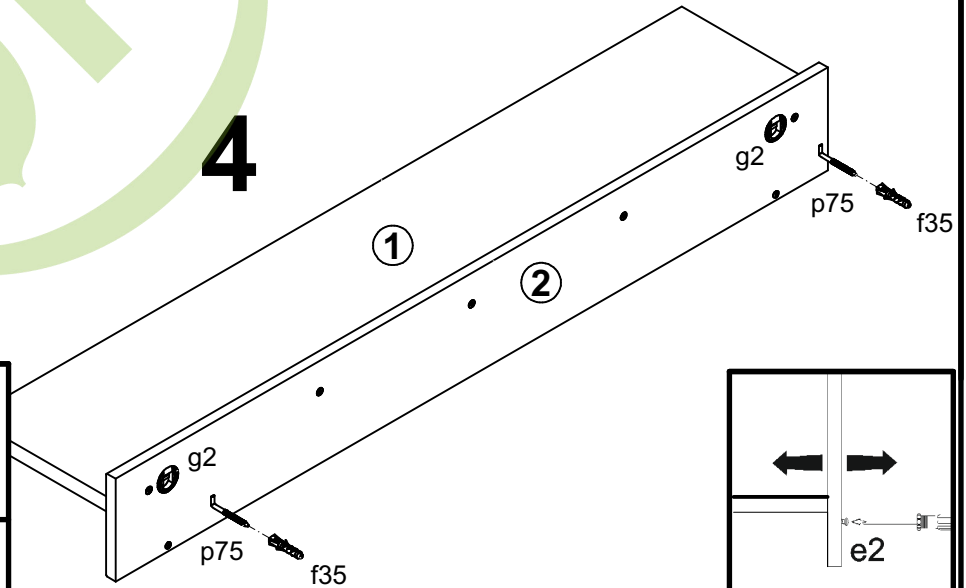

5

