

φ 10 mm

Max 10 kg

A	B	C (mm)		D
1	S174-006	1296	596	1/1
2	S174-1108	1284	350	1/1
3	S174-201	600	350	1/1
4	S174-301	567	331	1/1
5	S174-302	567	321	1/1
6	S174-303	567	321	1/1
7	S174-551	233	200	1/1
8	S174-553	391	260	1/1
9	S174-703-01	900	350	1/1
10	S174-704	184	350	1/1
11	S174-7714	175	200	1/1
12	S174-9901	1285	577	1/1
13	qc11/1			1/1

qc11/1

60 min

cm

3x  a2	3x  b1	1x  c34212	4x  d1 5x17 mm	9x  e47 6x16 mm	4x  p21 4x30 mm	16x  f1 8x30 mm	2x  f35 10x50 mm	4x  f6 8x50 mm	2x  j30 M4x22 mm	18x  l1	10x  l2	2x  n122
2x  o21 silikon	9x  o54 5.3/8, 3x4.8 mm	4x  p17 5x60 mm	24x  r1 15x12 mm #16	4x  r10	16x  r42	24x  s2 16	2x  n10					

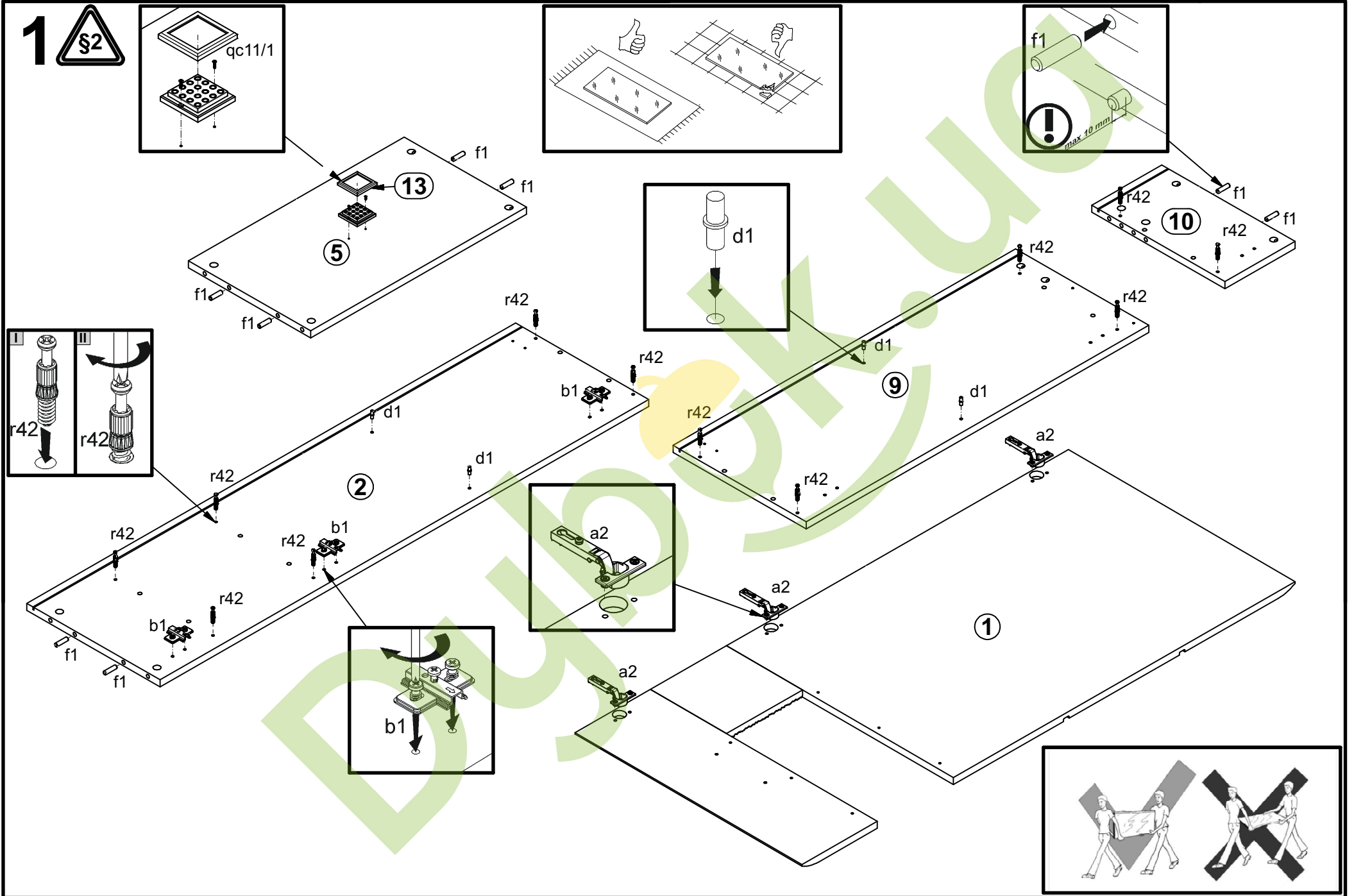

2

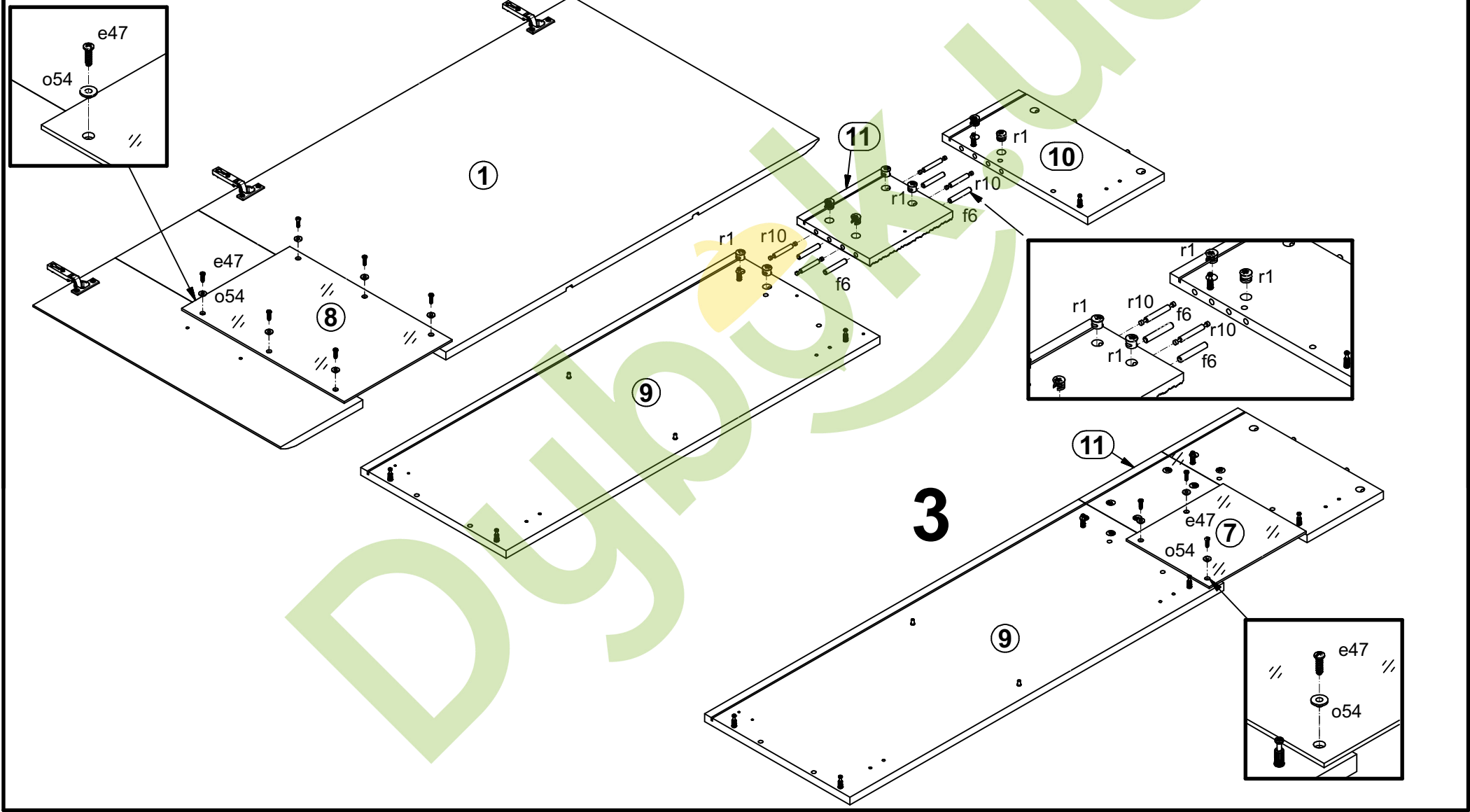
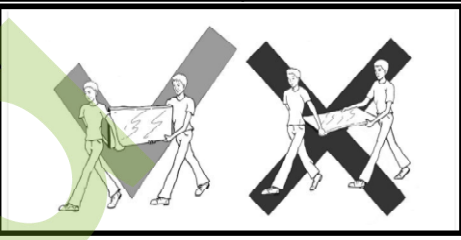
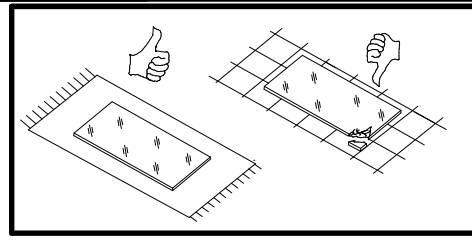

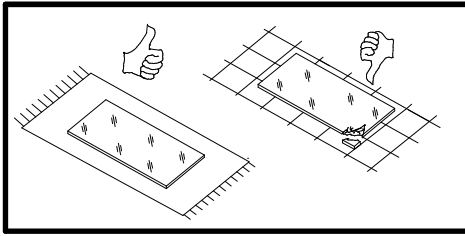

4

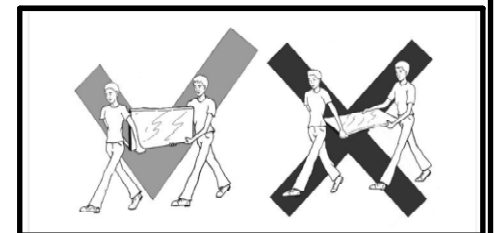
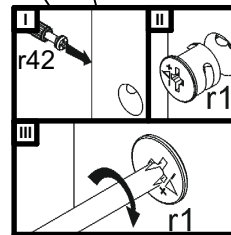
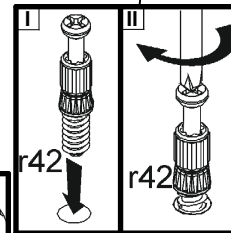
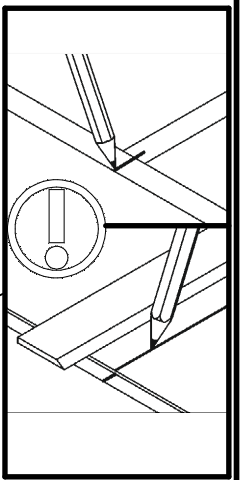
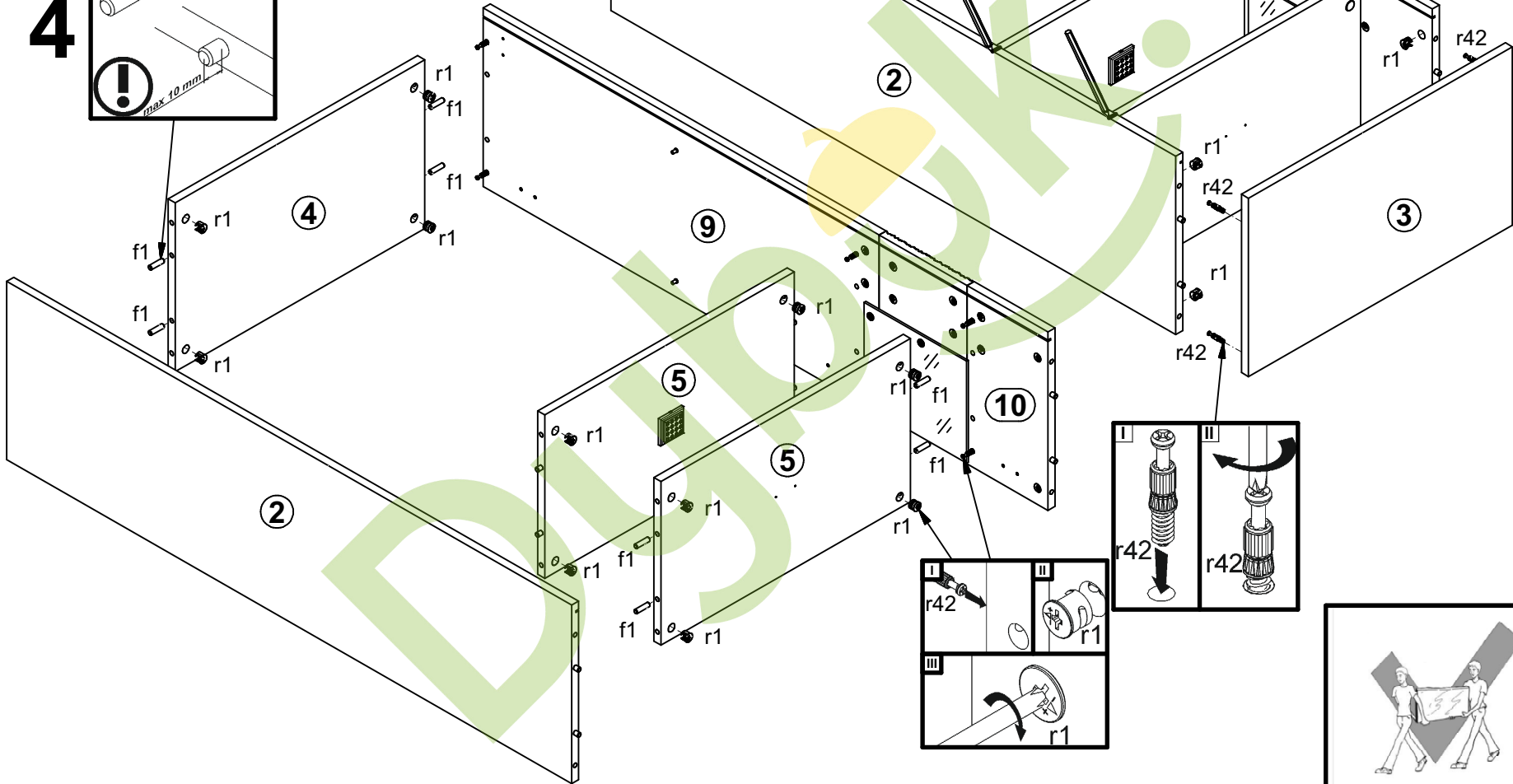
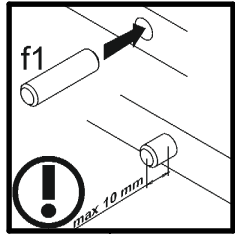

§11

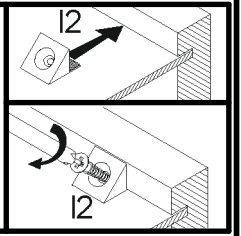
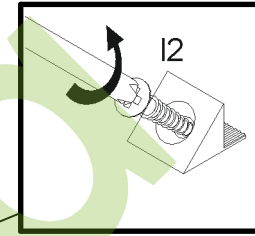
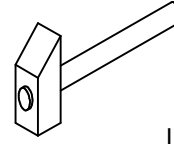
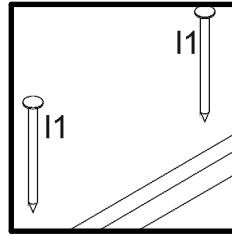
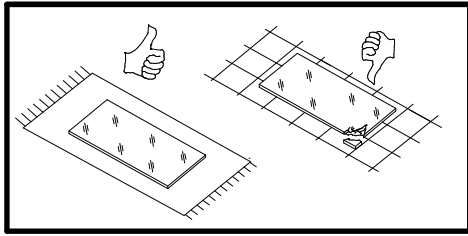

7

6

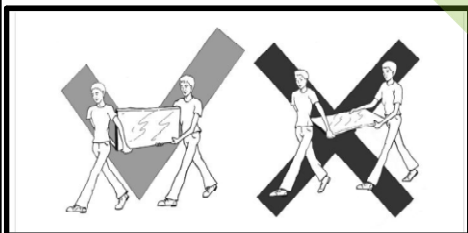
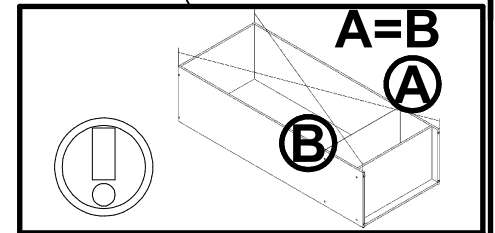
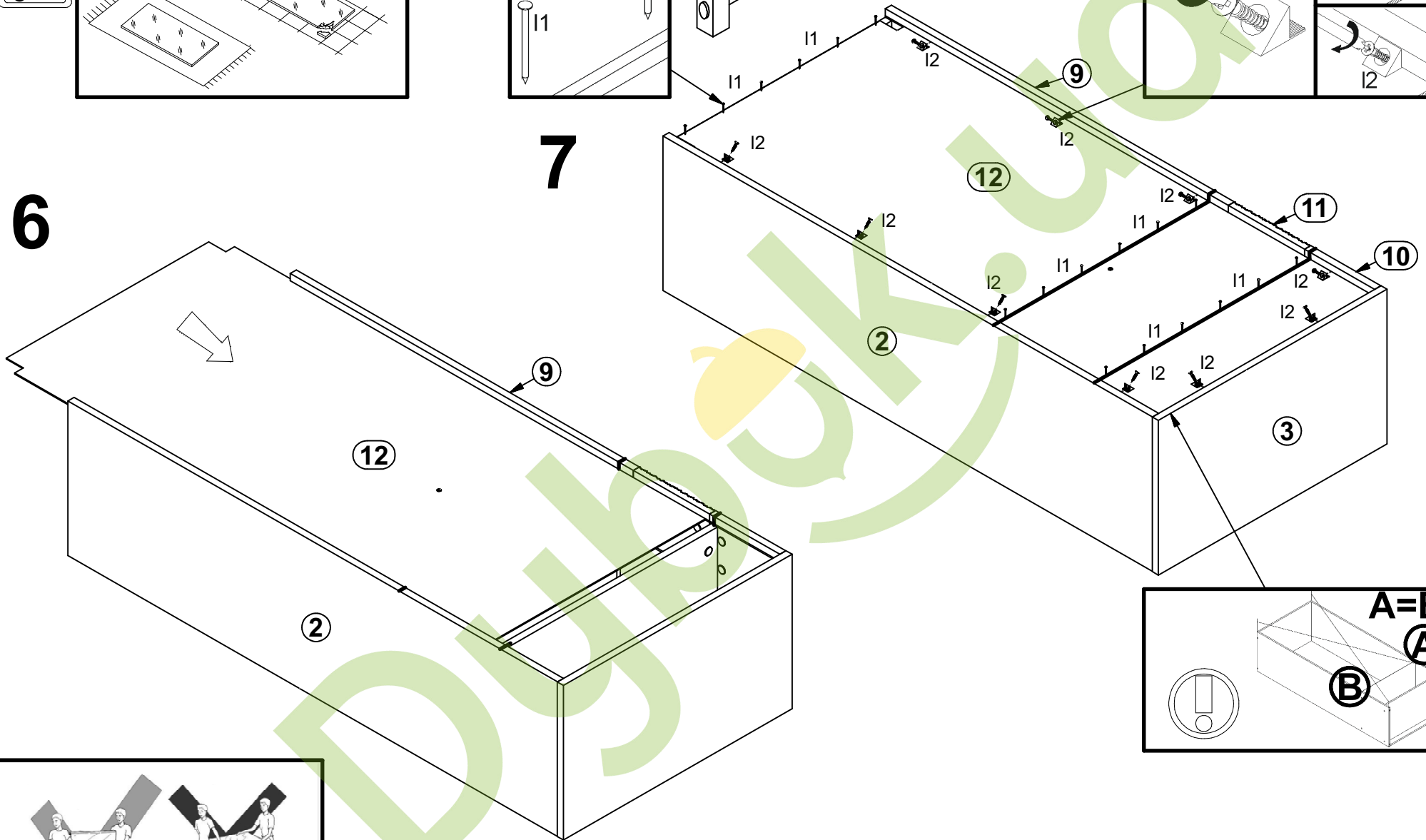

8

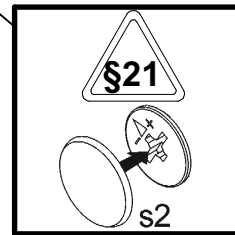
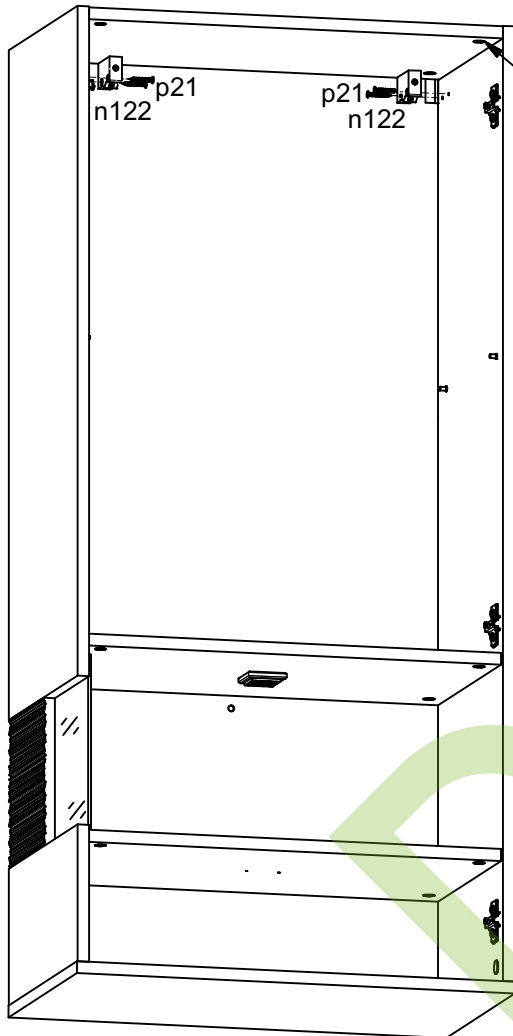
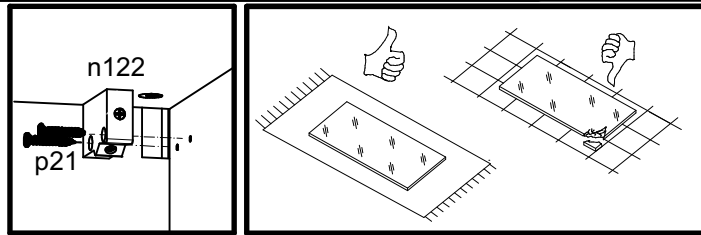

9

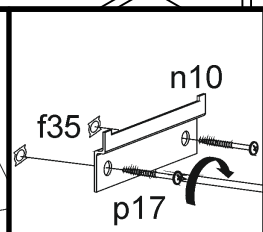
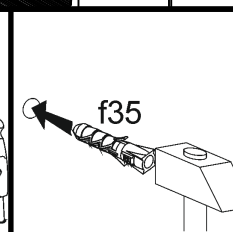
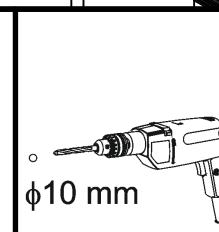
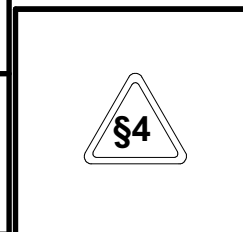
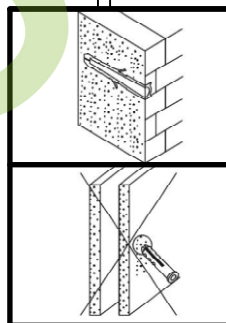
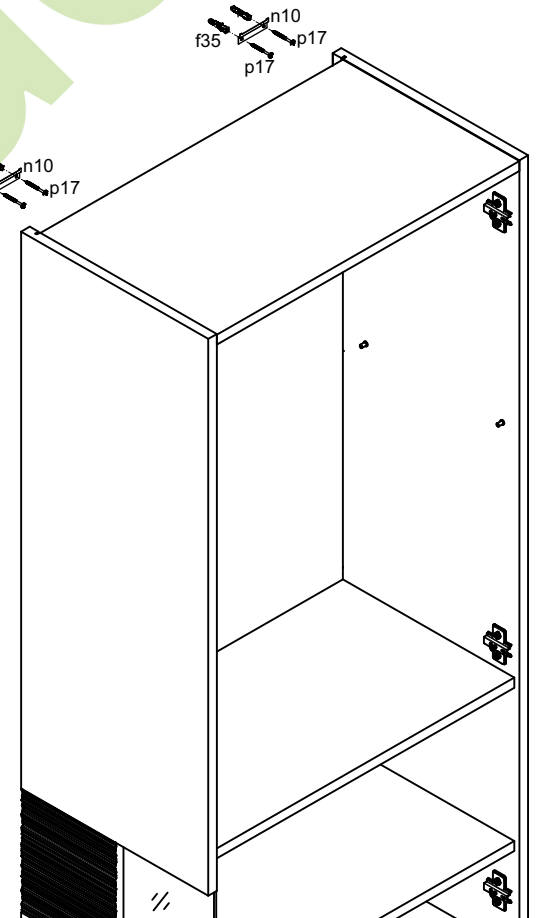
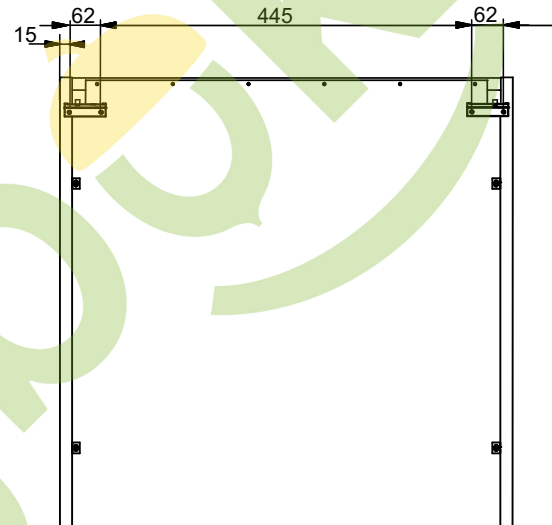



# 10

