

ENG

Folding wardrobe Lukas

UA

Розпашна шафа Лукас

2400x1600x500 mm

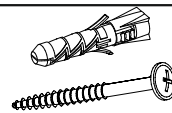
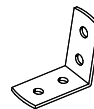
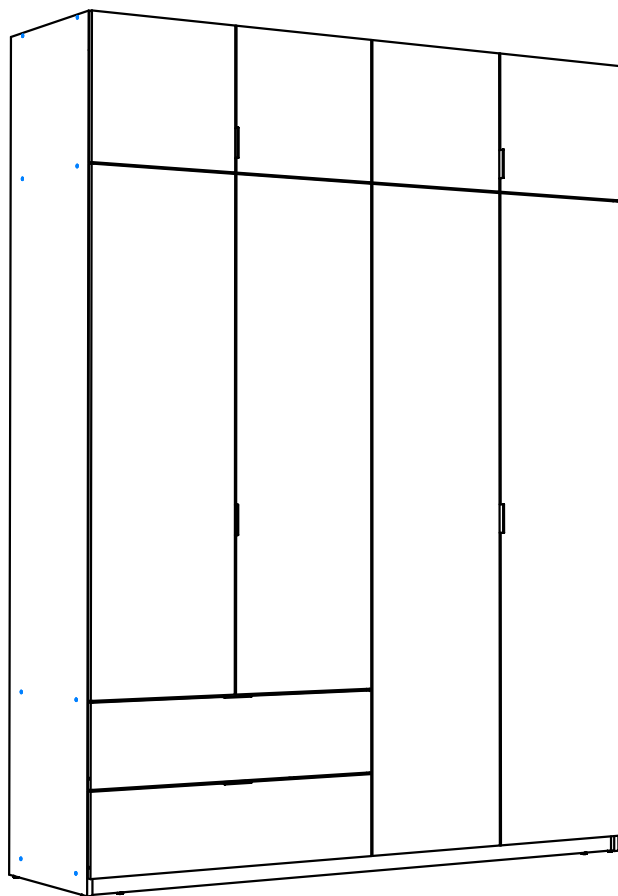
**To avoid falling**

we recommend fixing the product to the wall using **corners** or **double-sided tape**

ENG

Щоб уникнути падіння виробу

рекомендуємо закріпити його до стіни кутиками чи двосторонньою стрічкою.

UA

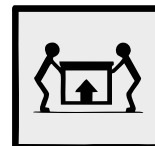

ENG



UA

RULES FOR USE AND CARE OF FURNITURE

1. Use furniture only in dry rooms protected from the effects of weather conditions.
2. Install with suitable tools according to these assembly instructions.
3. Try to assemble as close to the location as possible.
4. The body is assembling in a horizontal position.
5. Before moving furniture, make sure that it is not loaded with items.

Caution: moving furniture may damage it. When moving, hold on to vertical elements only; moving furniture by horizontal parts can break the product.

6. Overloading the furniture can damage it.
7. From time to time check the fittings and their correct position.
8. Wipe the furniture surface only with a slightly damp cloth or paper towels. Do not use chemical cleaning agents other than those specifically made for this.

ПРАВИЛА ВИКОРИСТАННЯ ТА ДОГЛЯДУ ЗА МЕБЛЯМИ

1. Використовуйте меблі тільки в сухих приміщеннях, захищених від впливу погодних умов.
2. Виконуйте установку за допомогою відповідних інструментів відповідно до даної інструкції зі складання.
3. Намагайтеся проводити збірку якомога ближче до місця використання.
4. Збірка корпусу здійснюється в горизонтальному положенні.
5. Перед переміщенням меблів переконайтеся, що вони не навантажені.

Увага: переміщення меблів може привести до її пошкодження.

При переміщенні тримайтеся тільки за вертикальні елементи, переміщаючи меблі за горизонтальні деталі ви можете зламати виріб.

6. Перевантаження меблів може привести до їх пошкодження.
7. Час від часу перевіряйте кріплення і правильність їх положення.
8. Протирайте поверхню меблів тільки добре віджатою вологою тканиною або ж паперовими рушниками. Не використовуйте хімічні засоби для очищення, крім спеціально для цього призначених.

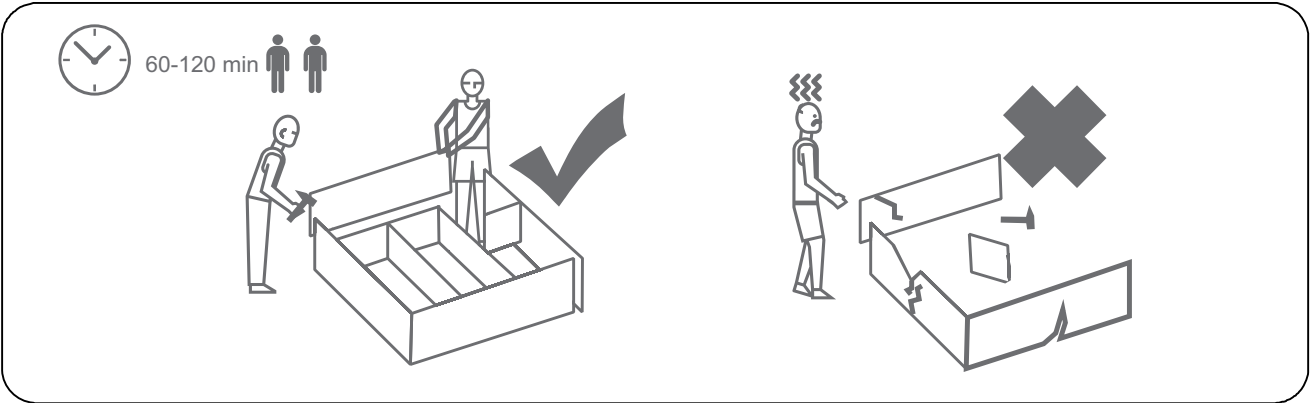
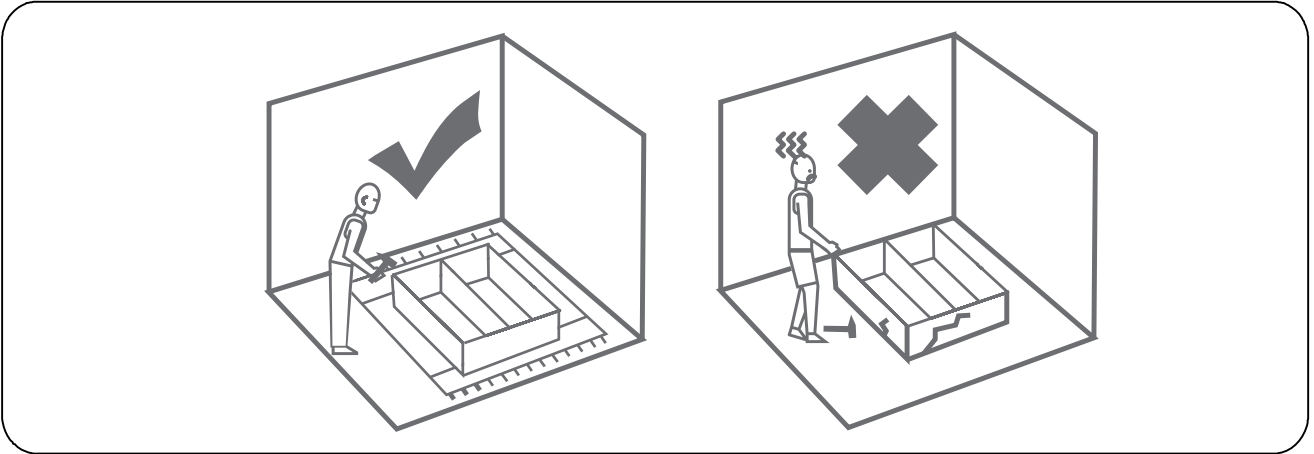
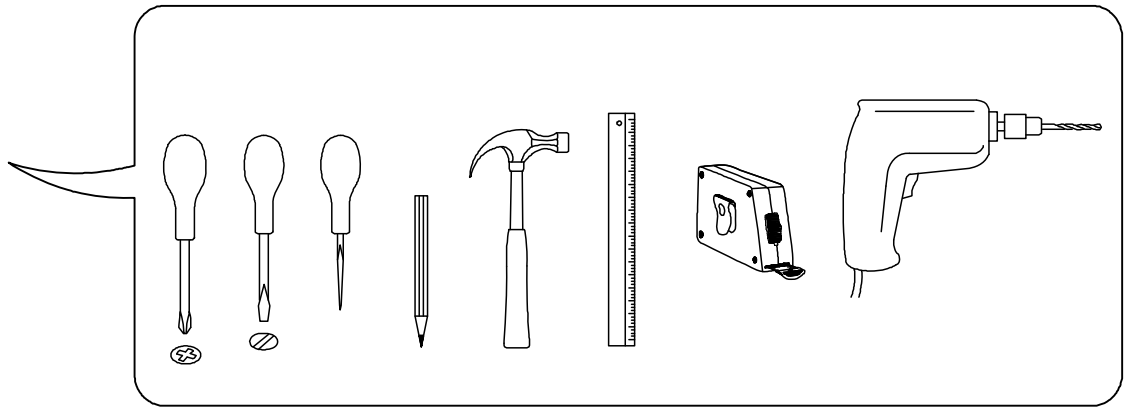

60-120 min

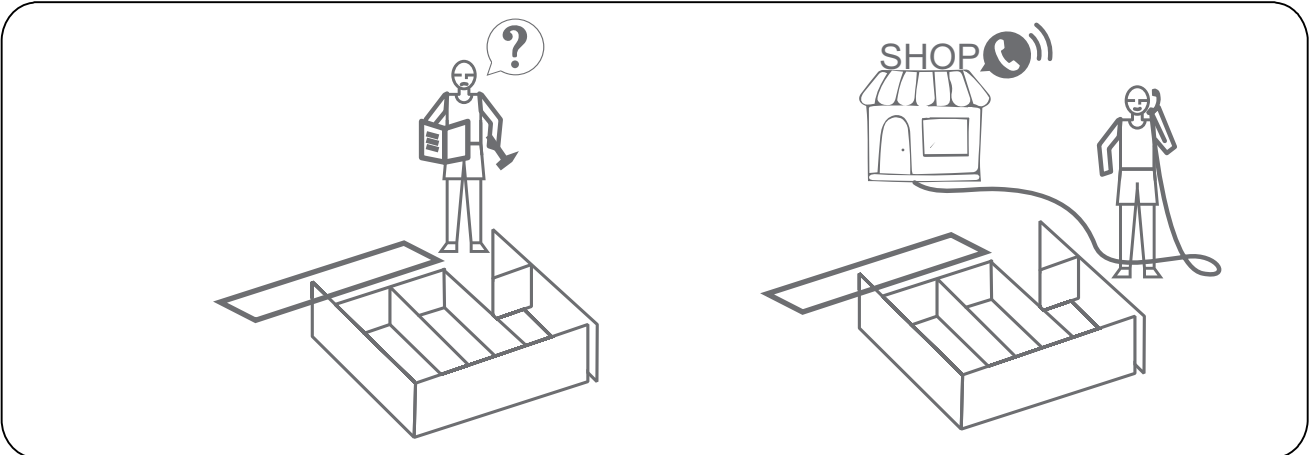

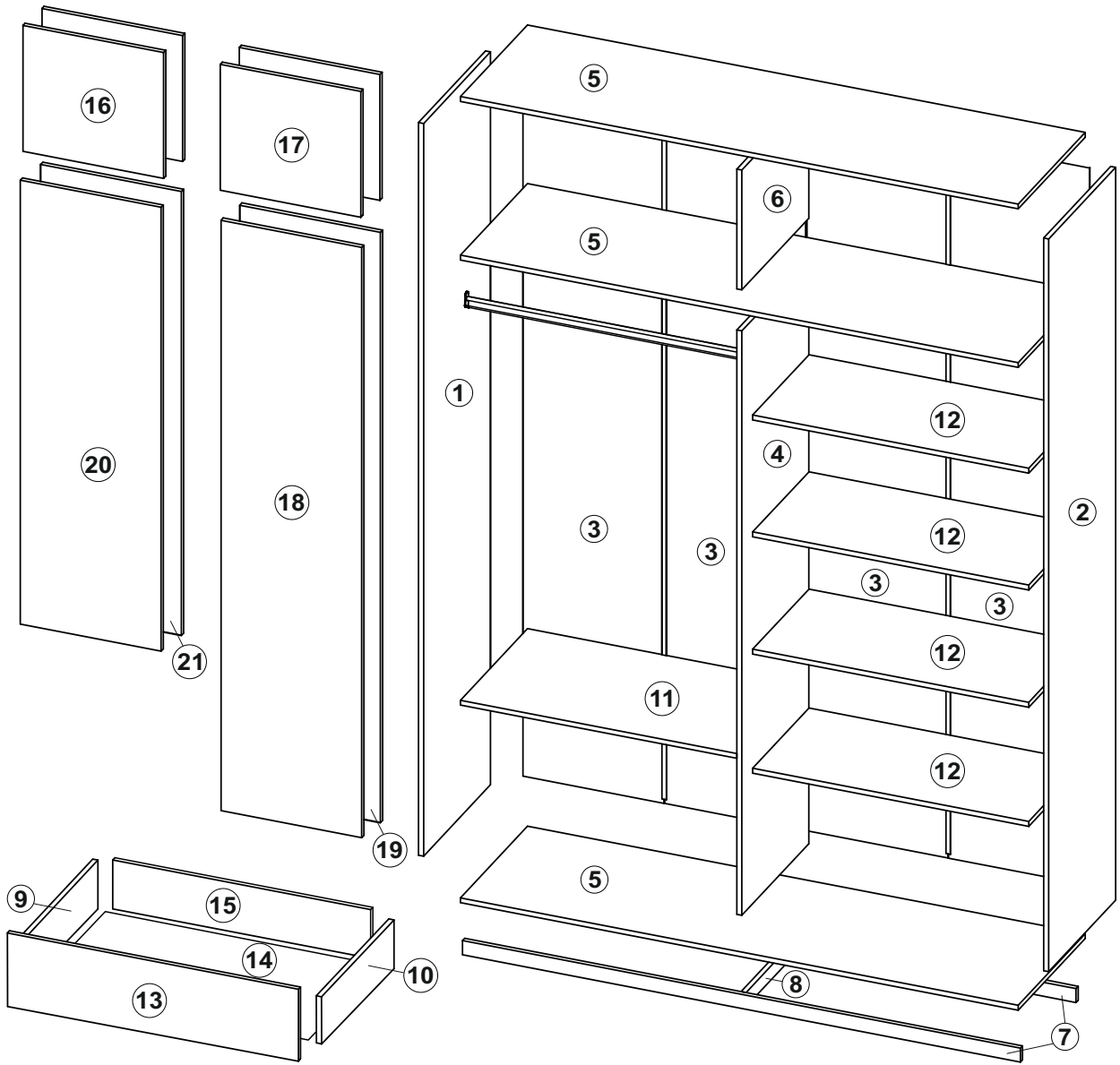

№	size / розмір	pack / уп.	qty / к-ть
1	2400 500	1/4	1
2	2400 500	1/4	1
3	2350 397	1/4	4
4	1914 500	2/4	1
5	1568 500	2/4	3
6	392 500	2/4	1
7	1568 46	2/4	2

№	size / розмір	pack / уп.	qty / к-ть
8	400 46	2/4	1
9	450 160	2/4	2
10	450 160	2/4	2
11	776 500	3/4	1
12	775 420	3/4	4
13	796 235	3/4	2
14	748 455	4/4	2

№	size / розмір	pack / уп.	qty / к-ть
15	718 160	4/4	2
16	412 396	4/4	2
17	412 396	4/4	2
18	1934 396	4/4	1
19	1934 396	4/4	1
20	1454 396	4/4	1
21	1454 396	4/4	1

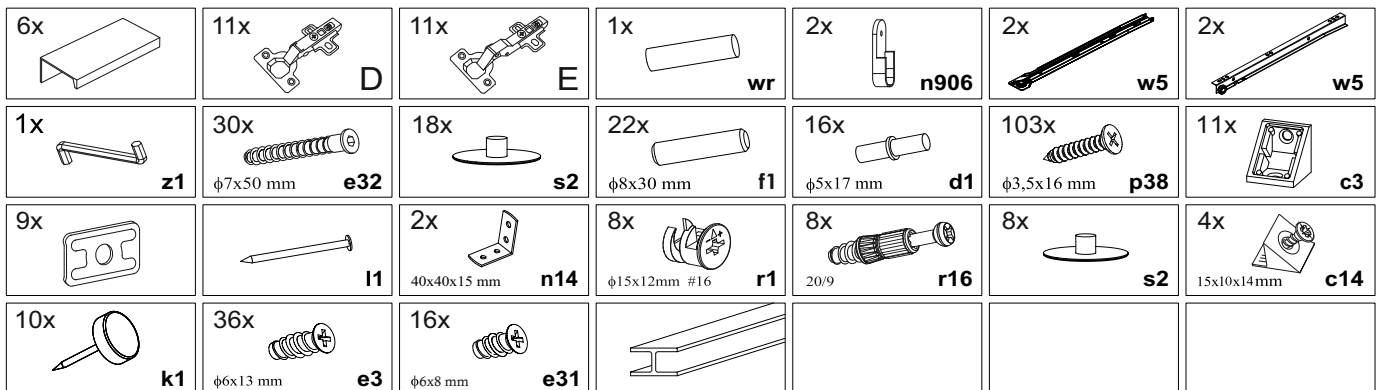

1

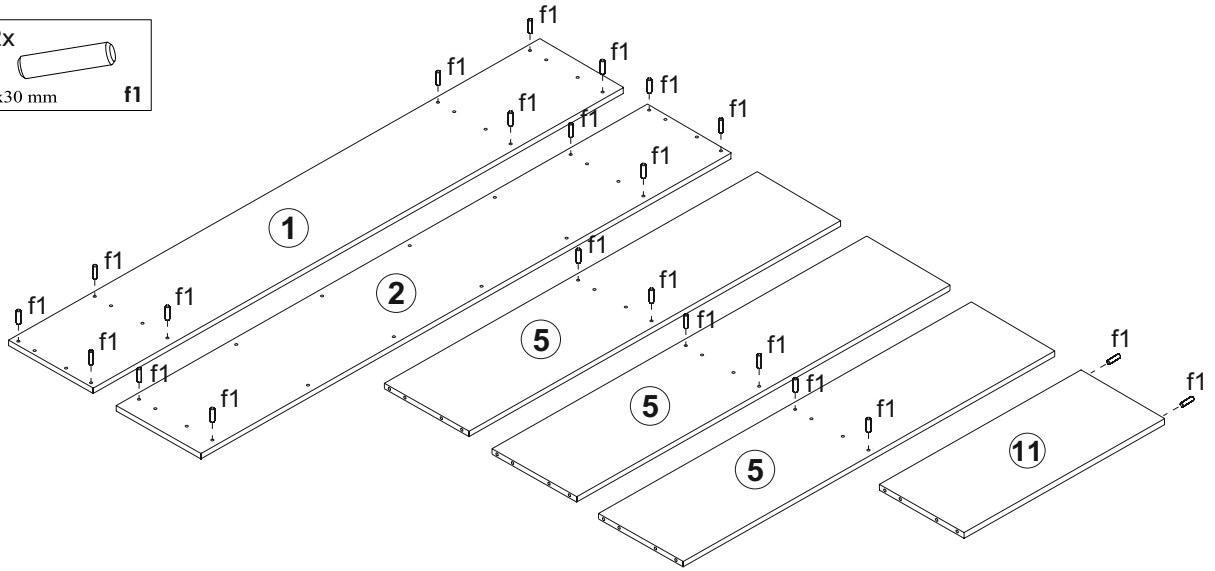
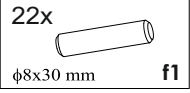

2

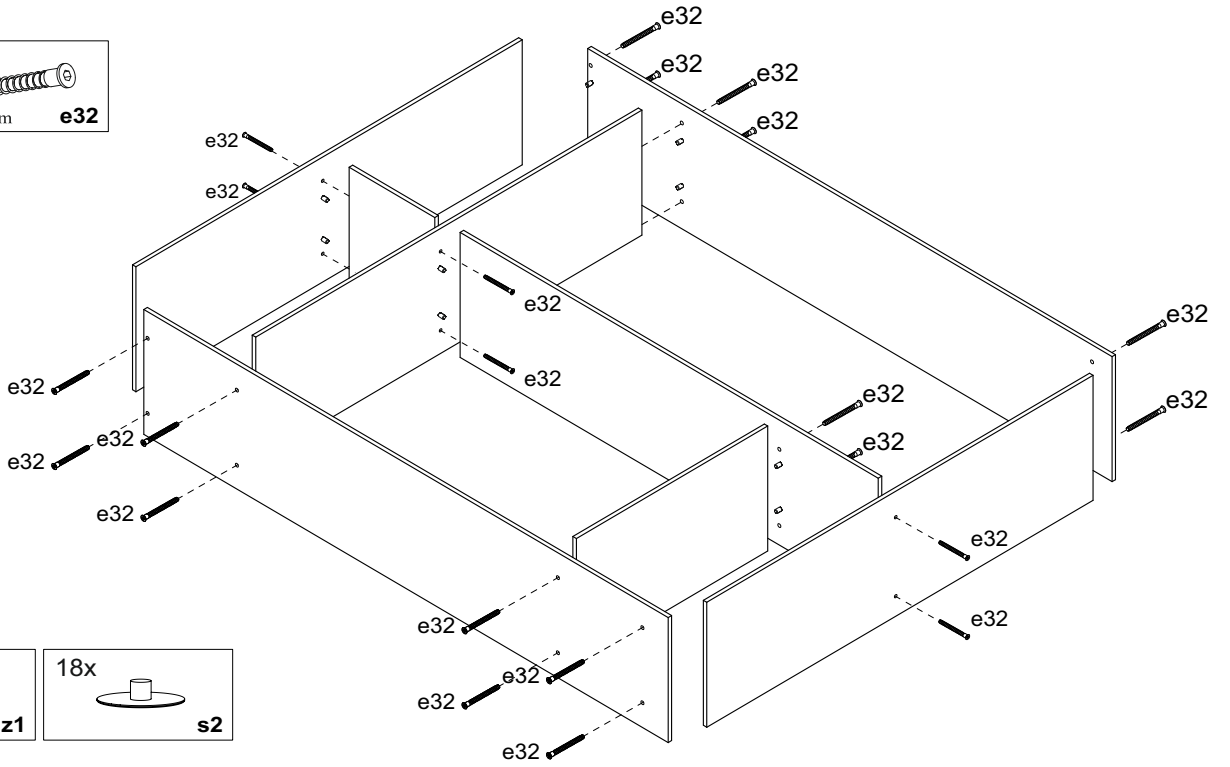
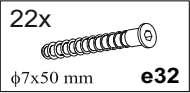

3

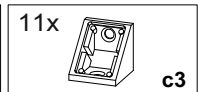
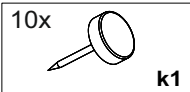
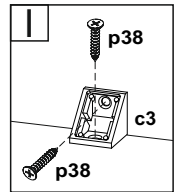

4

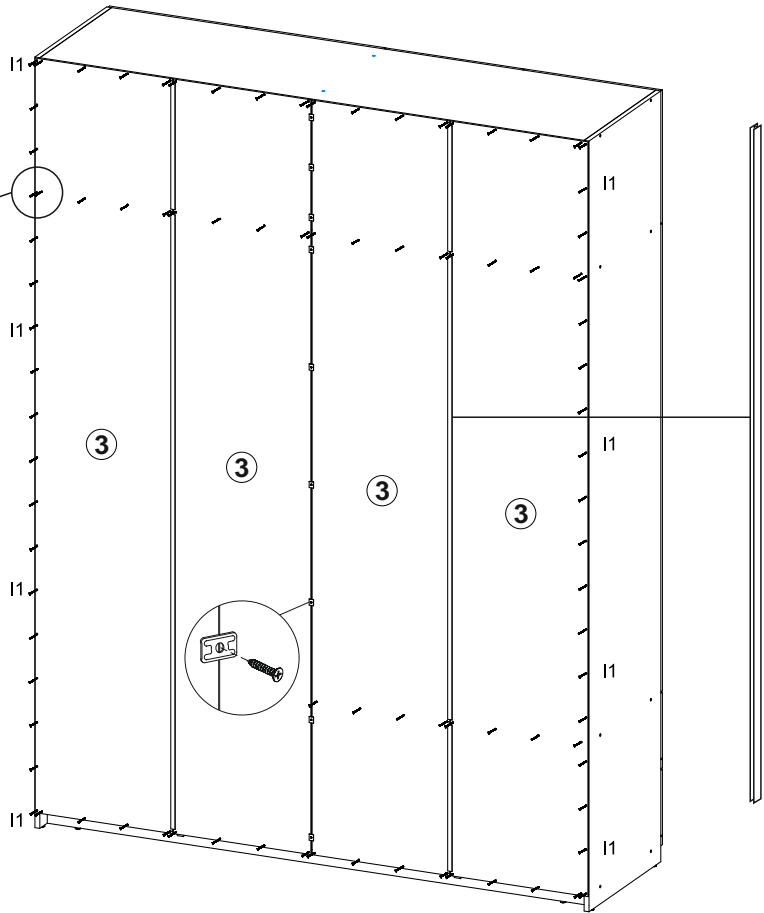
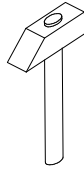
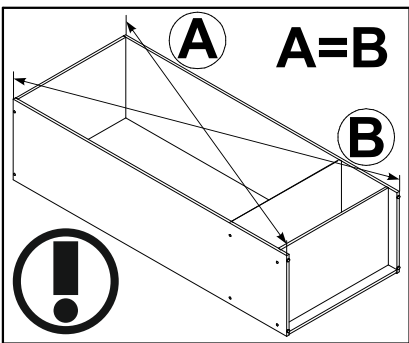
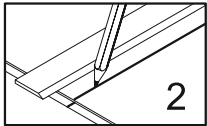
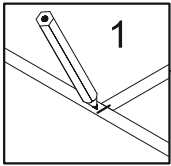
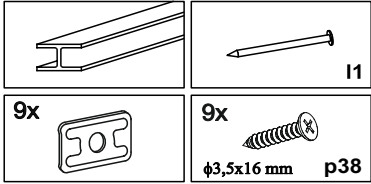

5

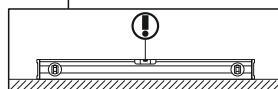
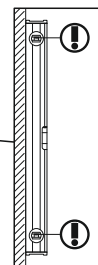
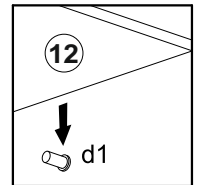
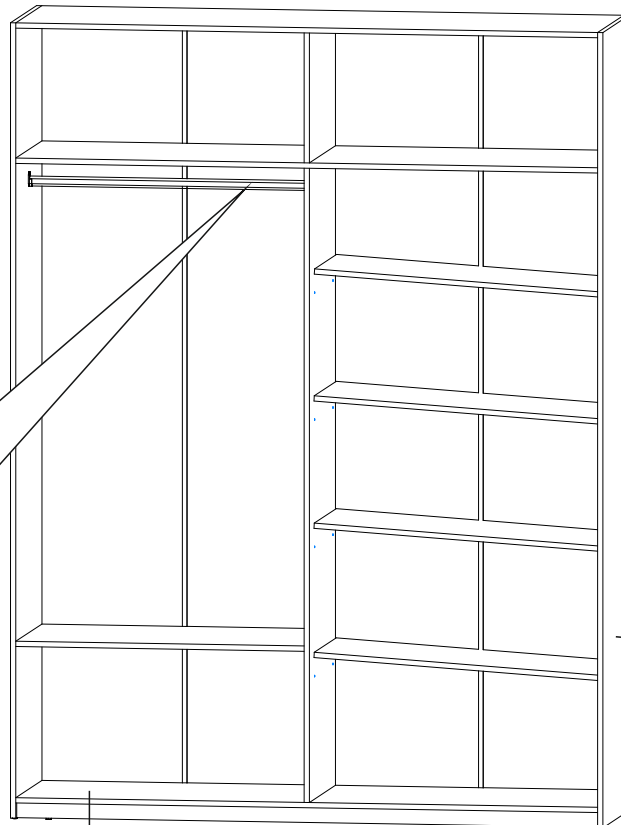
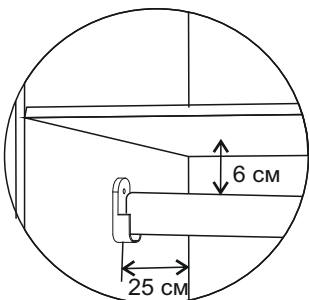
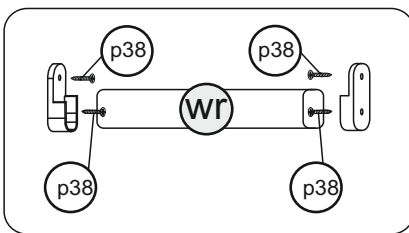
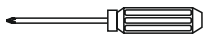
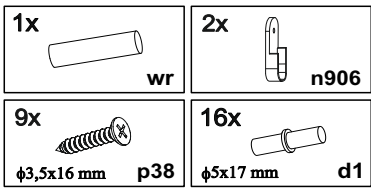

6



2x w5 (L)



2x w5 (R)

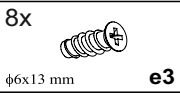

8x $\phi 6 \times 13$ mm e3

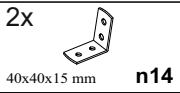

2x 40x40x15 mm n14

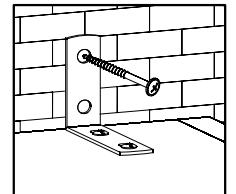
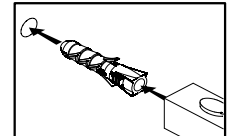
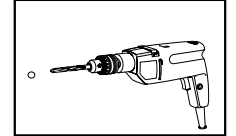
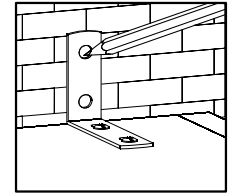
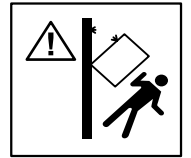
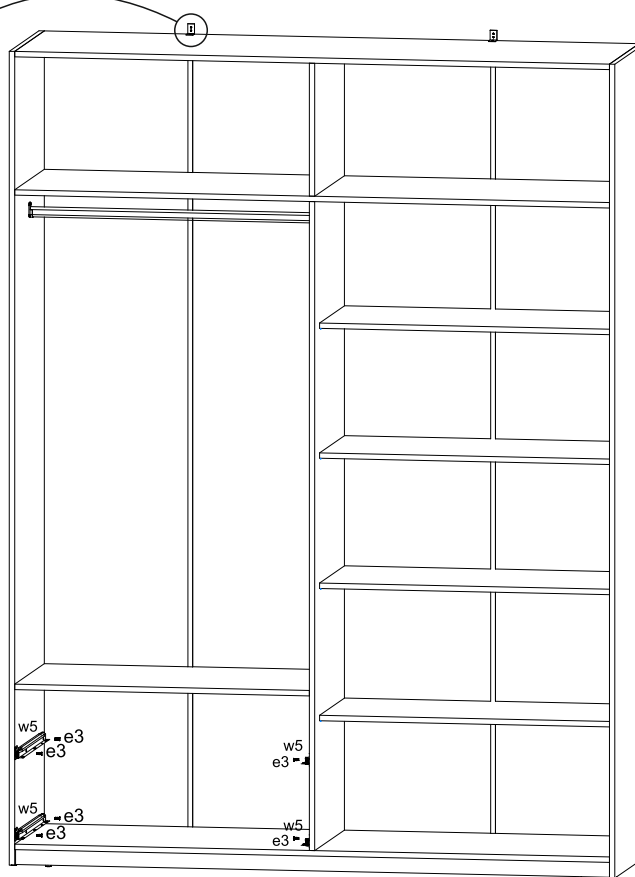
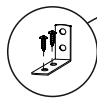



ENG
The dowels are not included.
Purchase separately.

UA
Дюбелі в комплект не входять.
Необхідно придбати окремо.

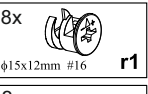
7

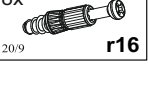

8x $\phi 15 \times 12$ mm #16 r1



8x 20/9 r16

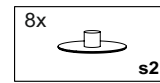
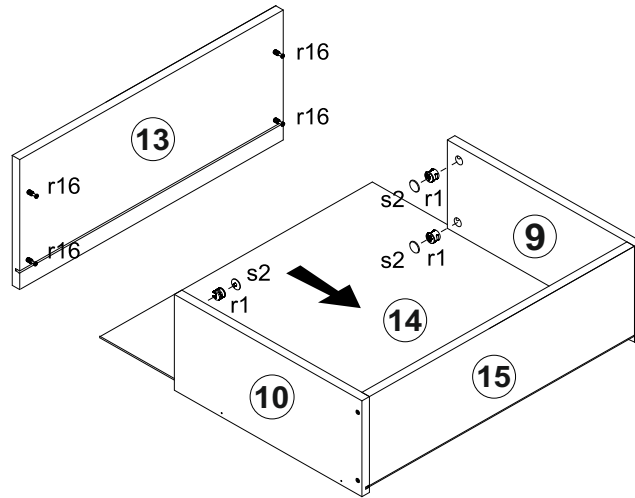
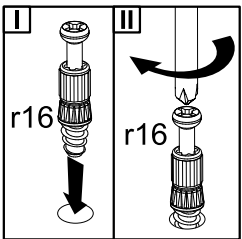

8x s2

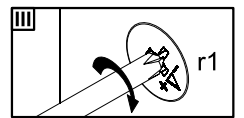
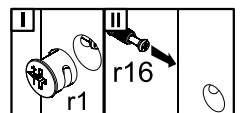
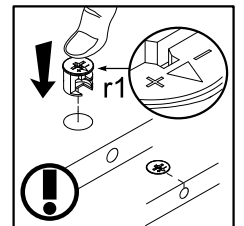

8

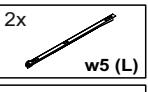

2x w5 (L)



2x w5 (R)

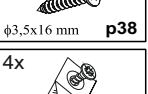

8x $\phi 3,5 \times 16$ mm p38

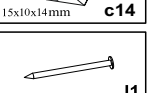

4x 15x10x14mm c14

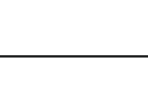

l1

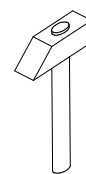
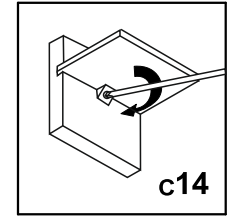
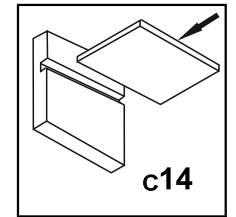
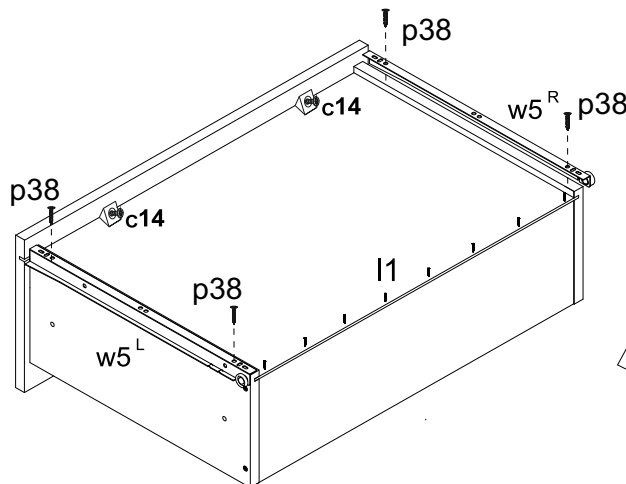

9

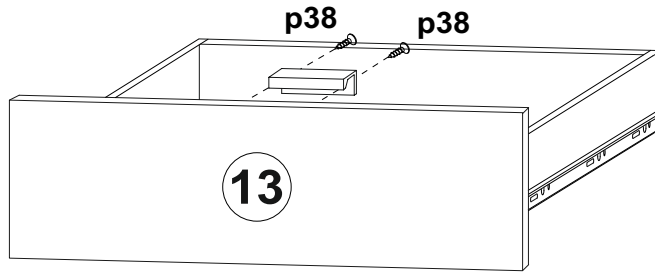
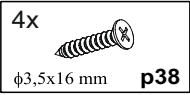
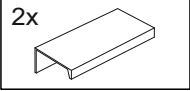

10

