

КАЛІПСО / КАЛИПСО

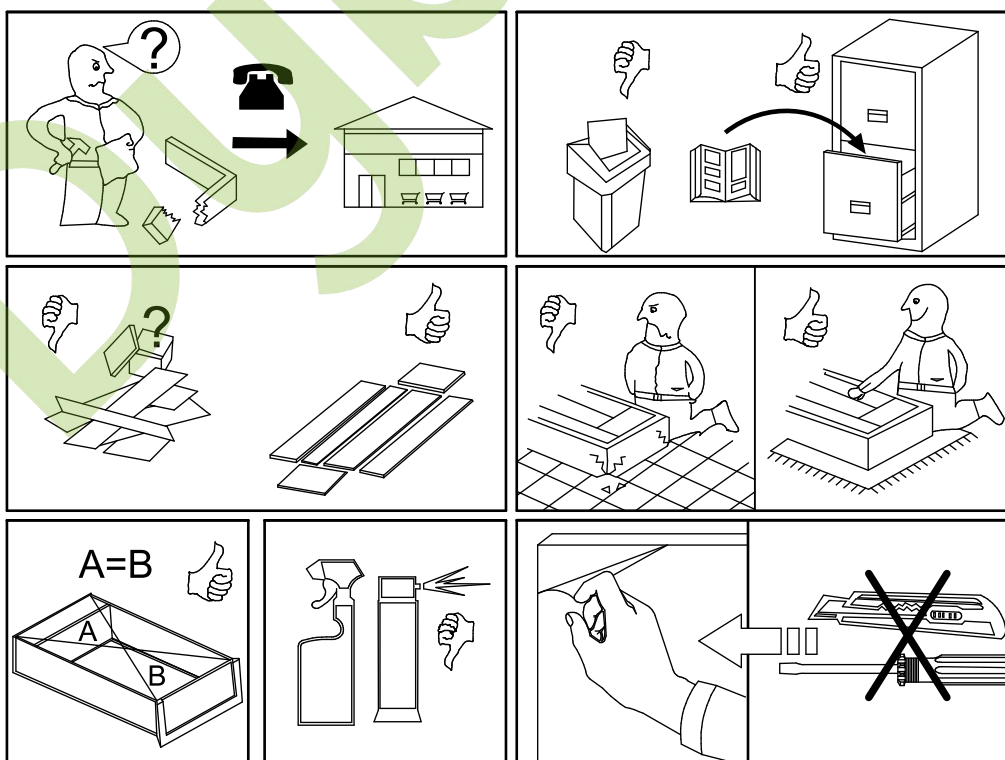

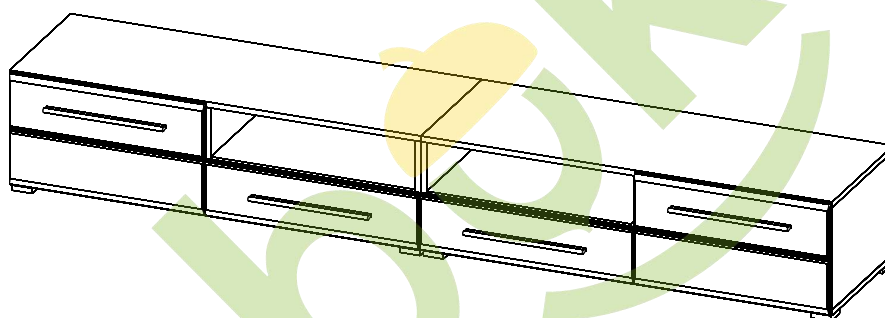

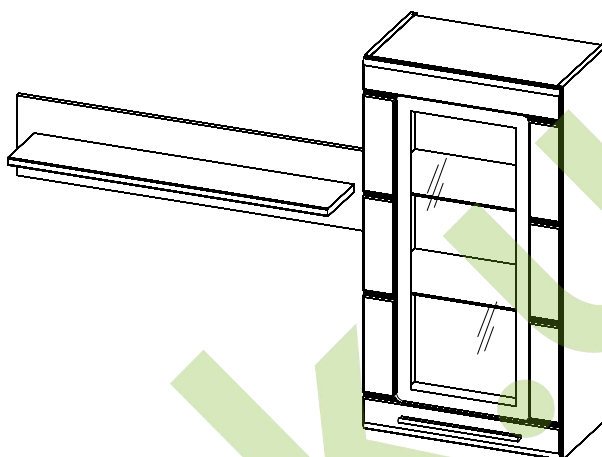

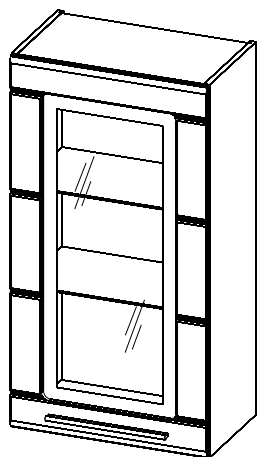
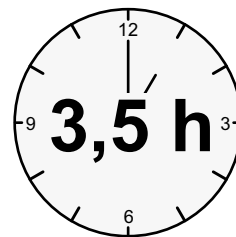
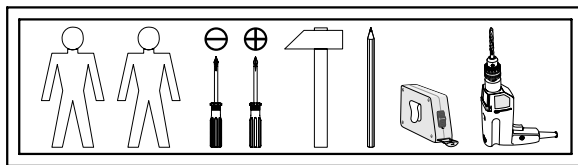
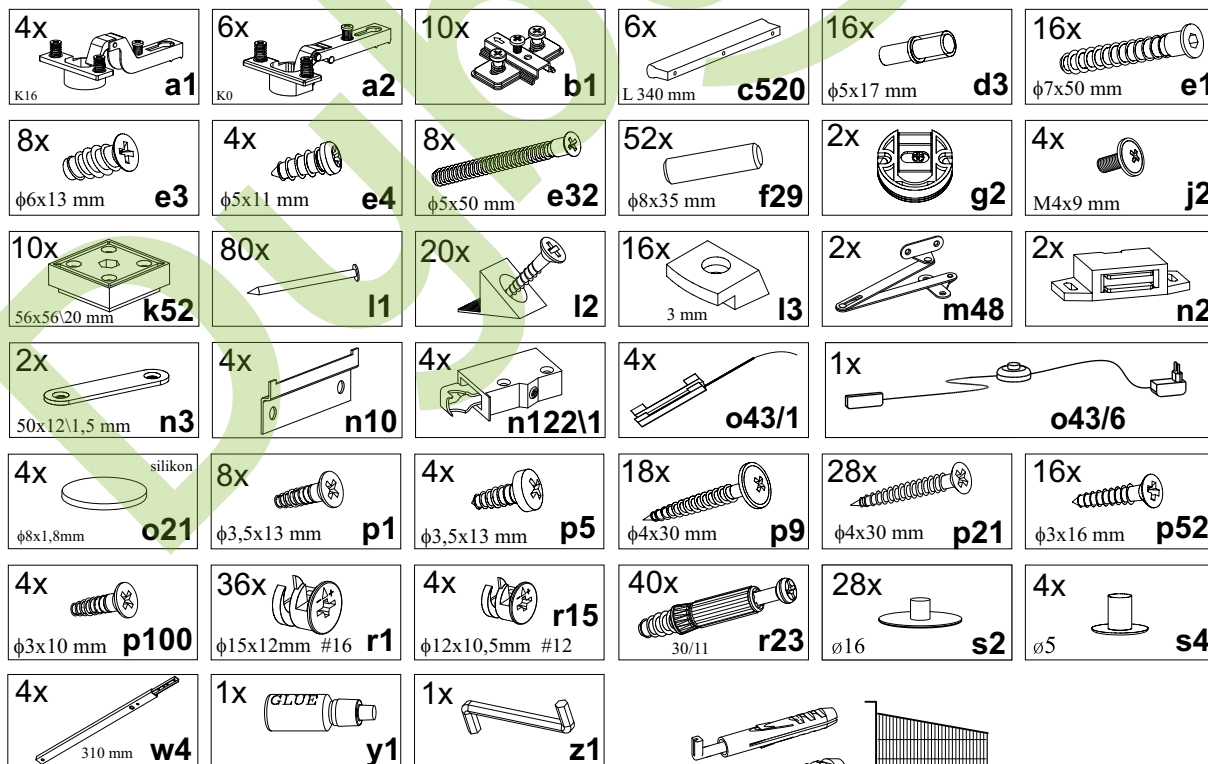
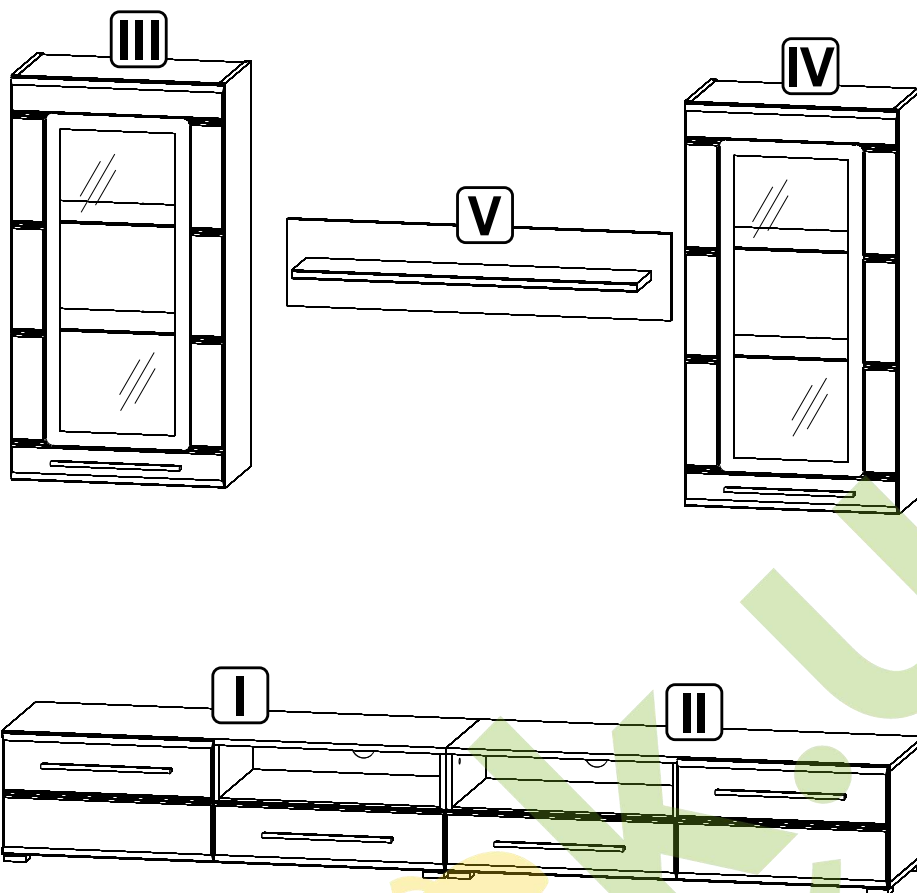

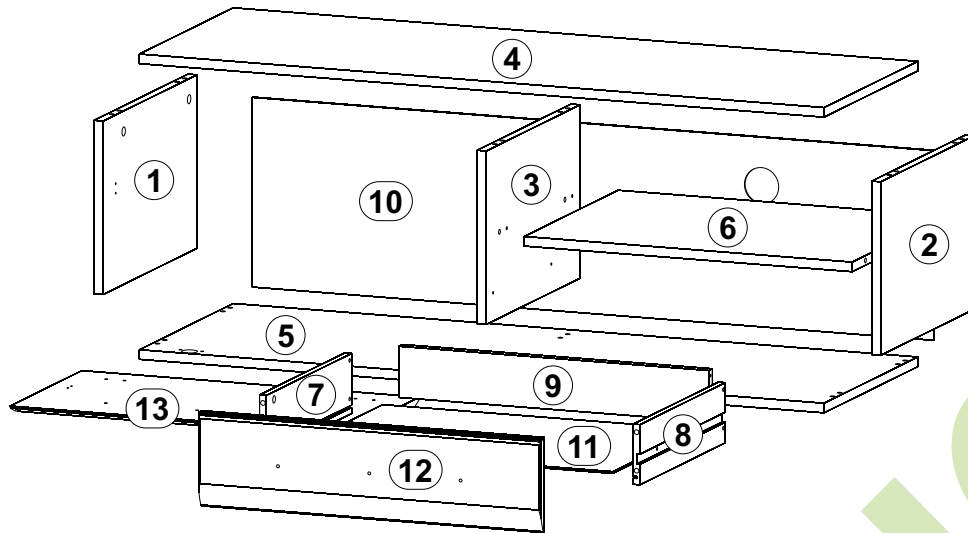

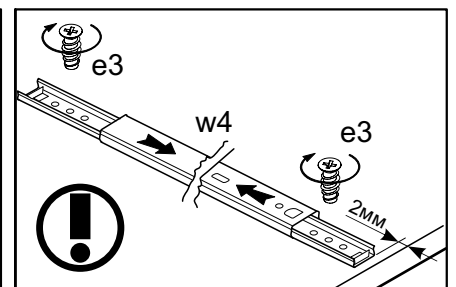
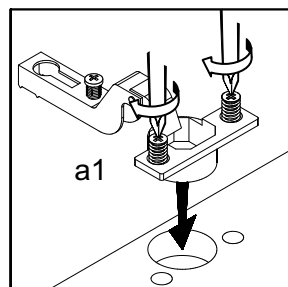
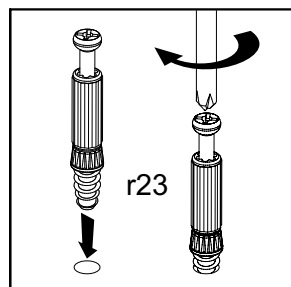
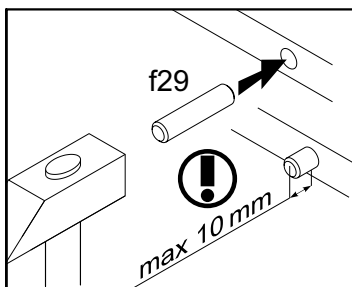
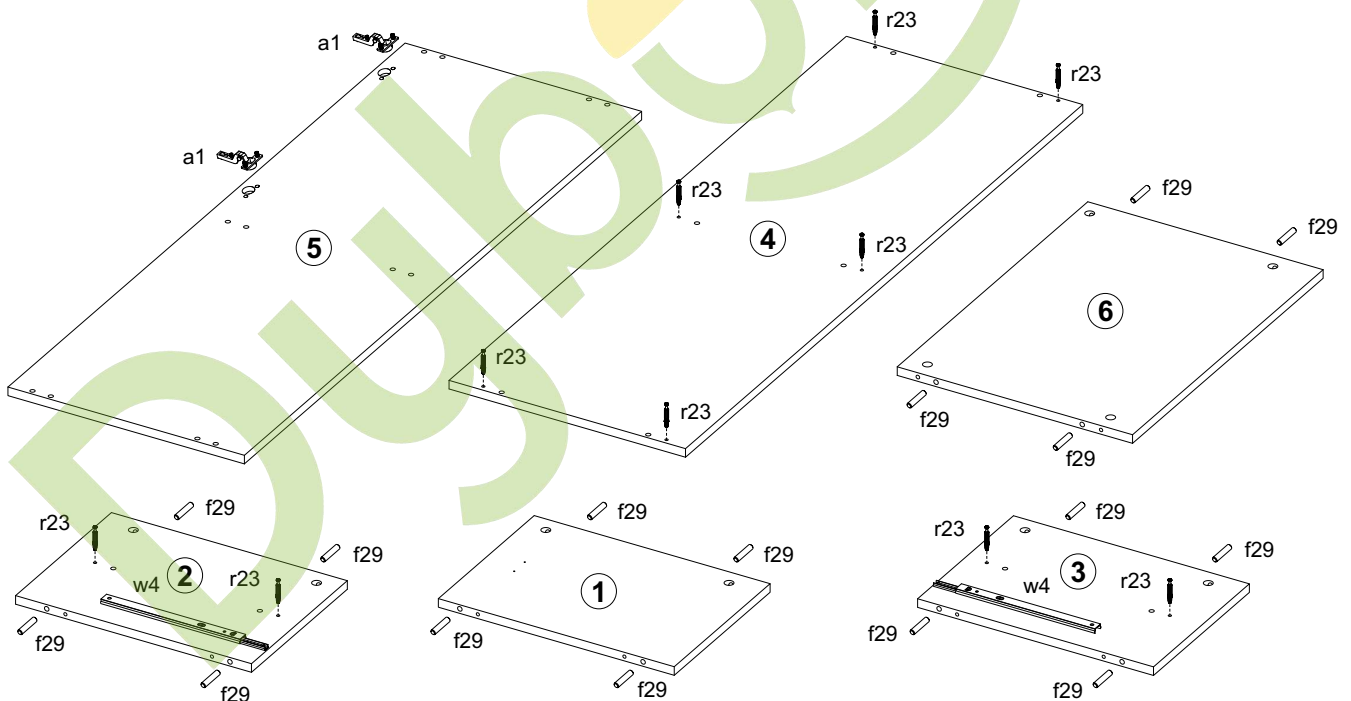
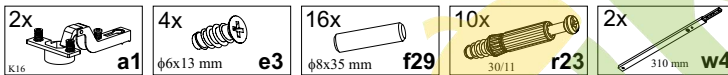

Тумба РТВ ліва / Тумба РТВ левая

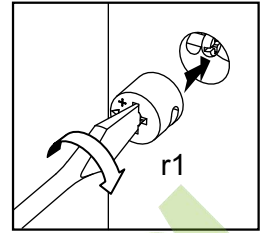
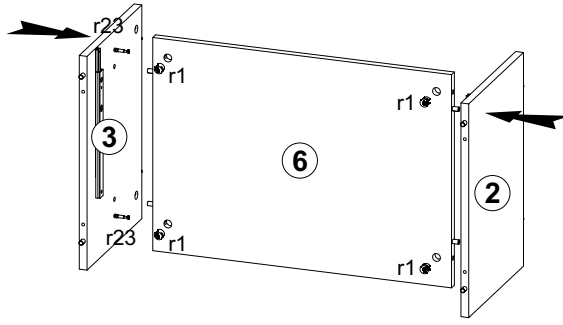

A	B	C	D	A	B	C	D		
1	PU1-101	288	413	1/4	8	PU1-552	375	100	1/4
2	PU1-103	288	413	1/4	9	PU1-553	543	85	1/4
3	PU1-102	288	413	1/4	10	PU1-913	1194	315	1/4
4	PU1-212	1200	413	1/4	11	PU1-904	554	378	1/4
5	PU1-213	1200	413	1/4	12	PU1-003A	600	158	4/4
6	PU1-301	575	413	1/4	13	PU1-014A	592	316	4/4
7	PU1-551	375	100	1/4					

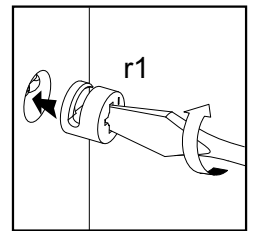
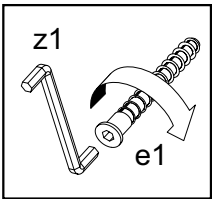
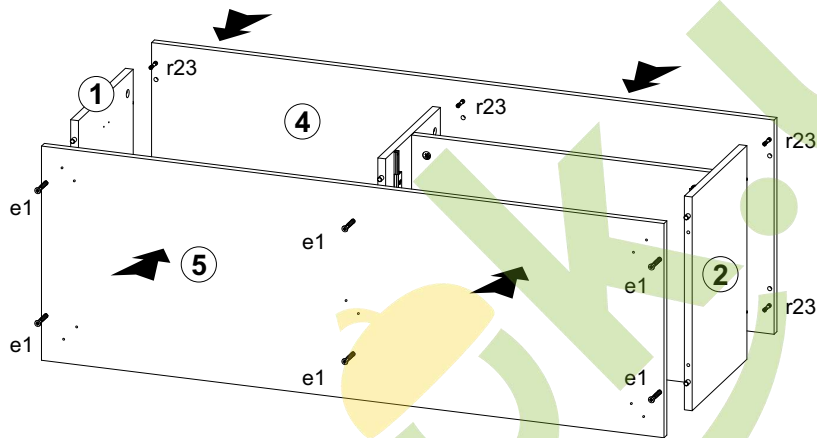

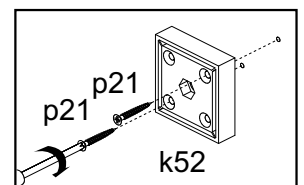
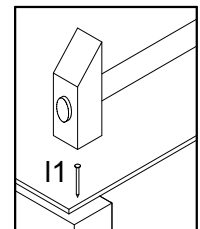
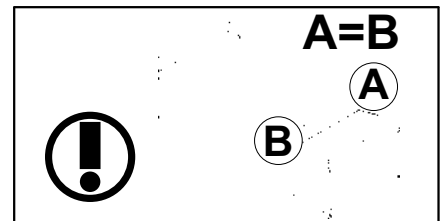
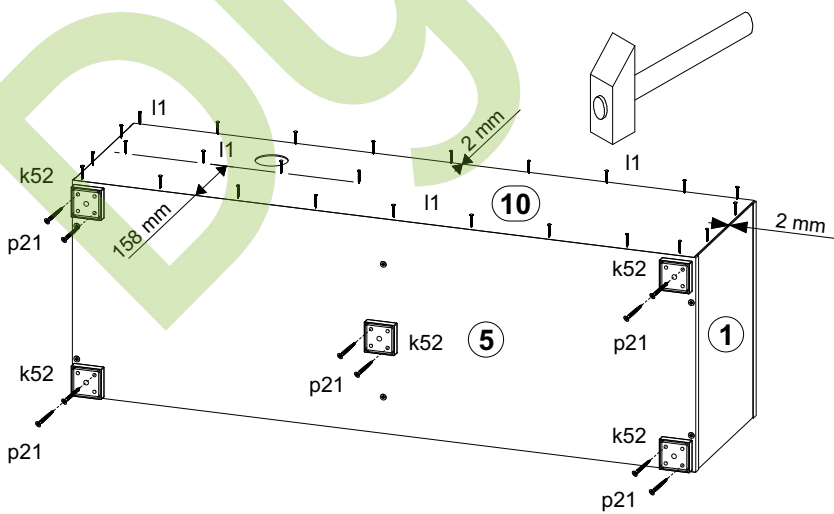



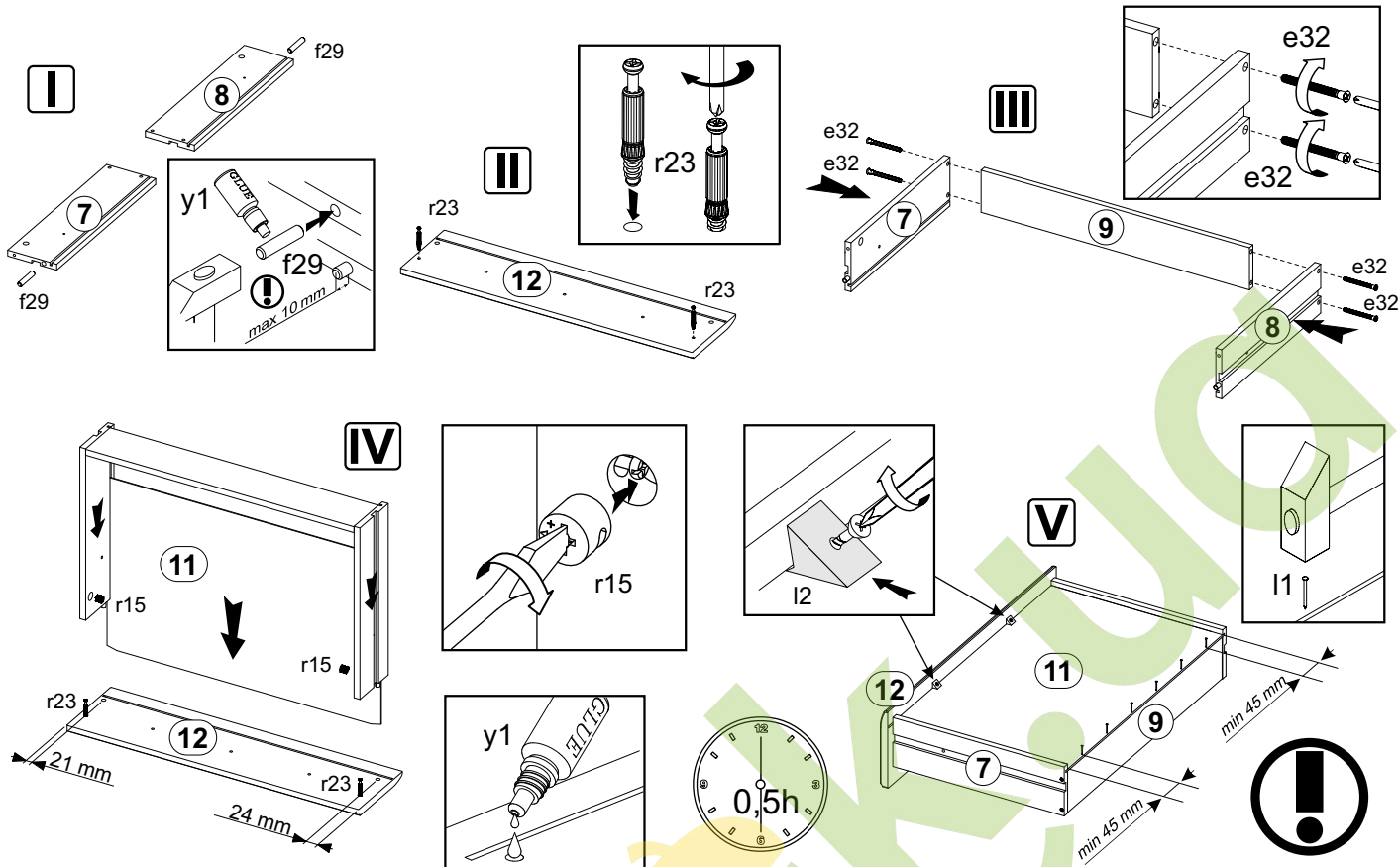

24x  $\phi 15 \times 12 \text{ mm}$ #16 r1**3**6x  $\phi 7 \times 50 \text{ mm}$ e16x  $\phi 15 \times 12 \text{ mm}$ #16 r11x  z1**4**36x  l15x  $56 \times 56 \times 20 \text{ mm}$ k5210x  $\phi 4 \times 30 \text{ mm}$ p21

5

- 4x  **e32**
φ5x50 mm
- 2x  **f29**
φ8x35 mm
- 6x  **l1**
- 2x  **l2**
φ12x10,5mm #12
- 2x  **r15**
φ12x10,5mm #12
- 2x  **r23**
3011
- 1x  **y1**



6

- 2x  **c520**
L 340 mm
- 2x  **j2**
M4x9 mm
- 1x  **m48**
- 4x  **p1**
φ3,5x13 mm
- 6x  **p9**
φ4x30 mm
- 6x  **s2**
φ16

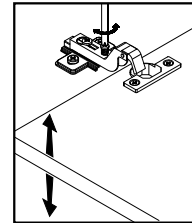
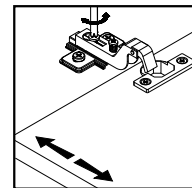
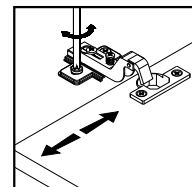
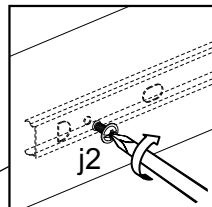
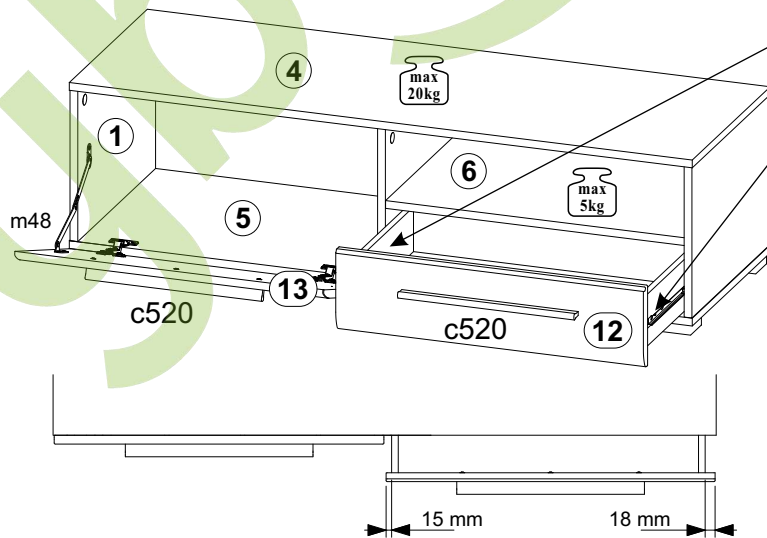
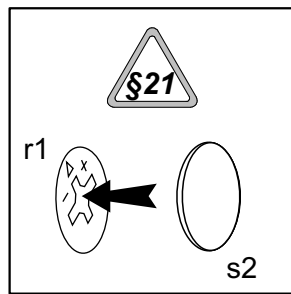
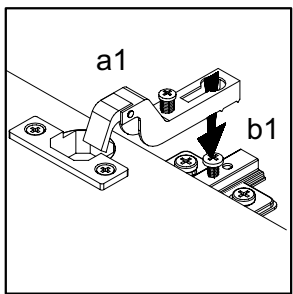
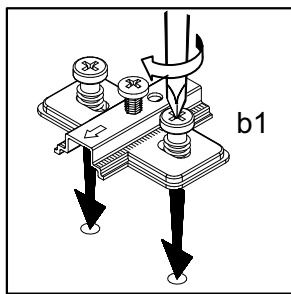
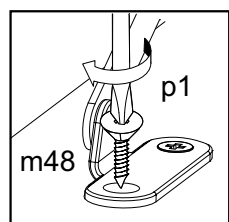
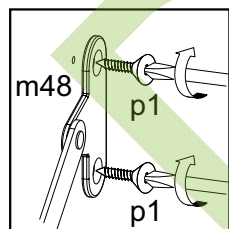
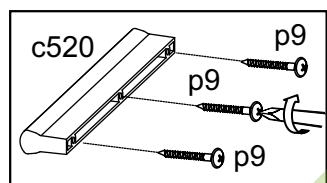



Тумба РТВ права / Тумба РТВ правая

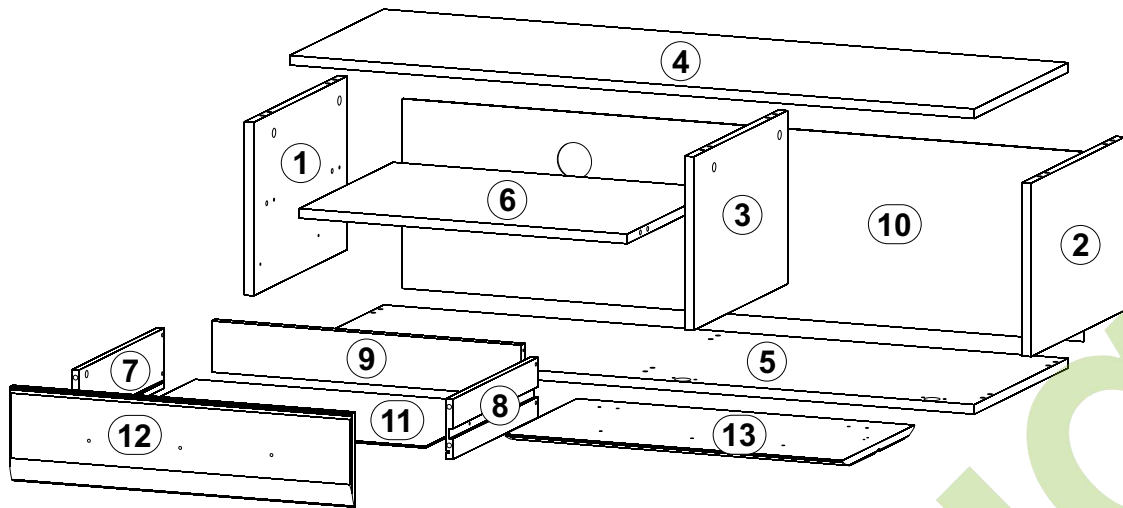





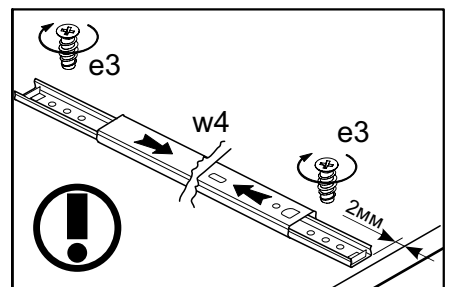
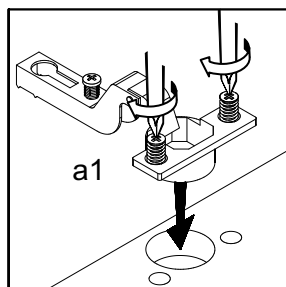
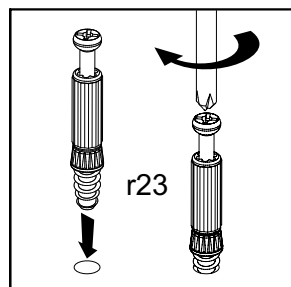
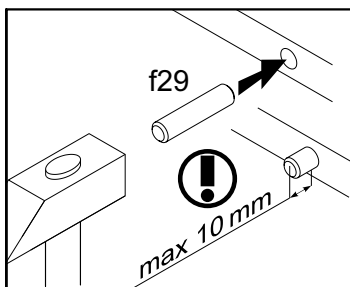
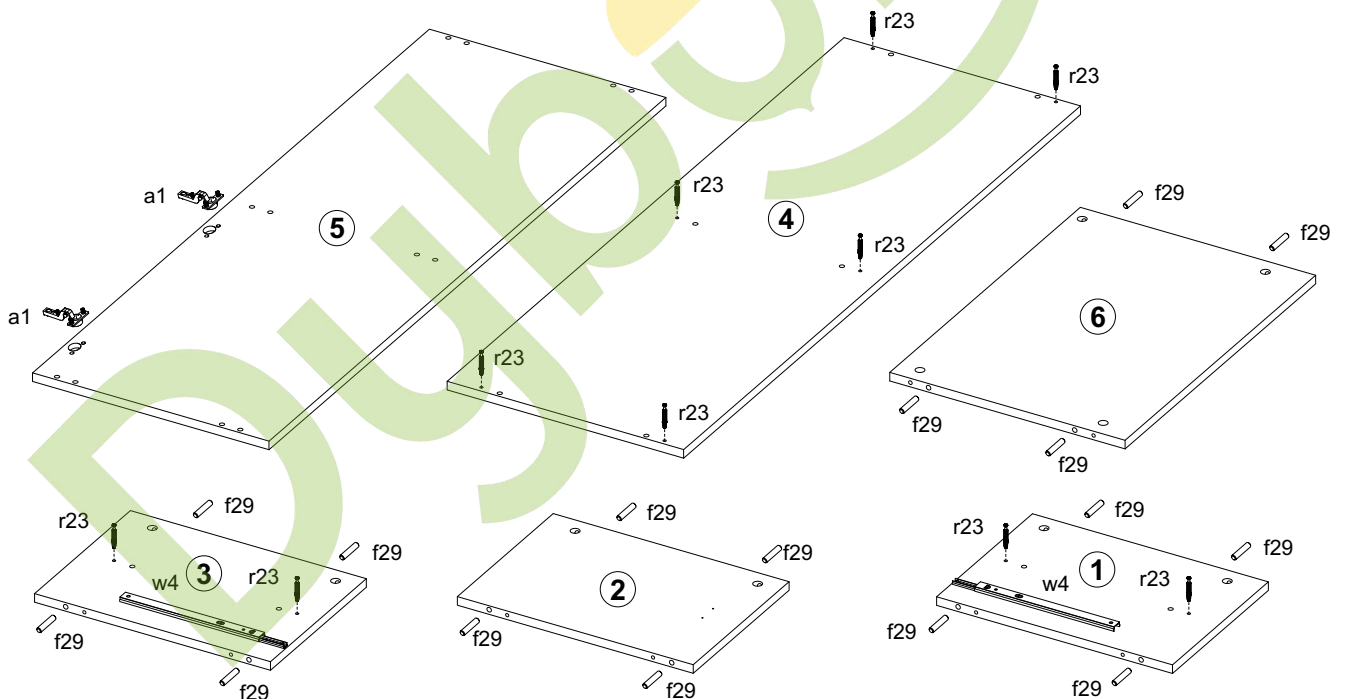
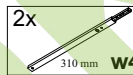
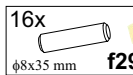
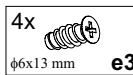
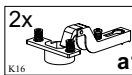

A	B	C	D	A	B	C	D		
1	PU1-104	288	413	2/4	8	PU1-552	375	100	2/4
2	PU1-106	288	413	2/4	9	PU1-553	543	85	2/4
3	PU1-105	288	413	2/4	10	PU1-914	1194	315	2/4
4	PU1-214	1200	413	2/4	11	PU1-904	554	378	2/4
5	PU1-215	1200	413	2/4	12	PU1-005A	600	158	4/4
6	PU1-301	575	413	2/4	13	PU1-015A	592	316	4/4
7	PU1-551	375	100	2/4					

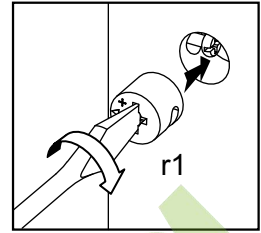
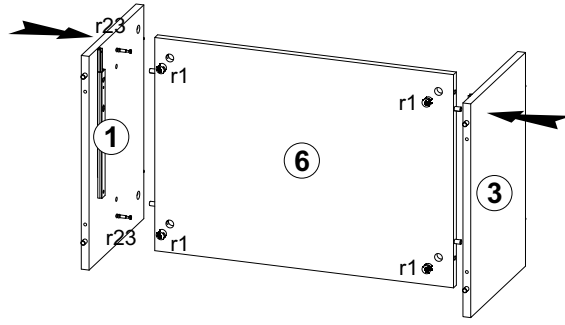

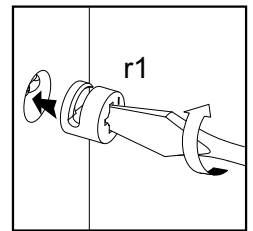
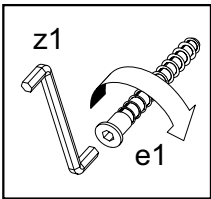
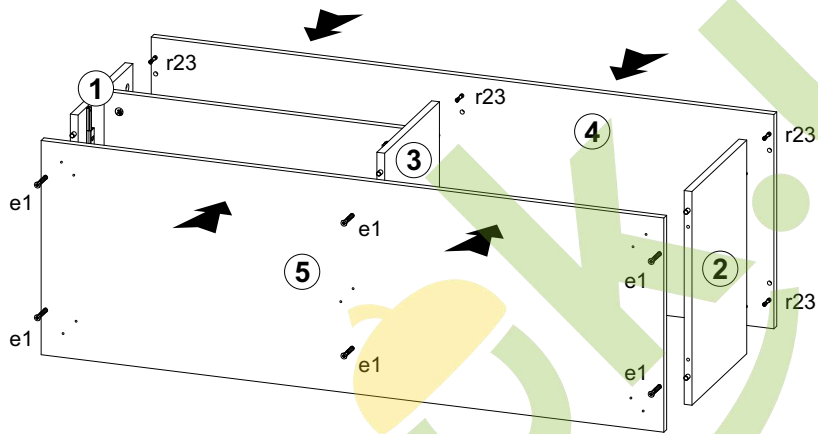
7

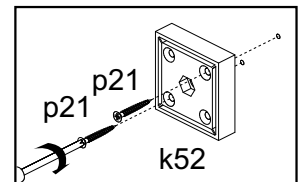
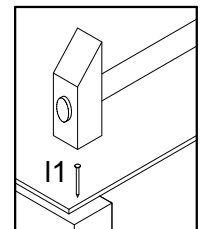
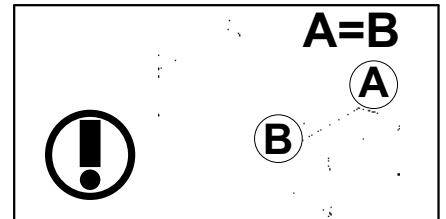
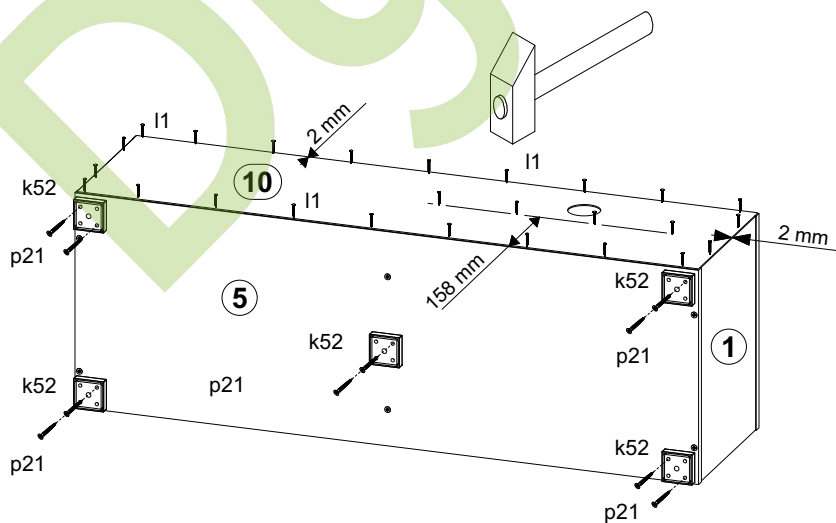

84x  $\phi 15 \times 12 \text{ mm}$ #16 r1**9**6x  $\phi 7 \times 50 \text{ mm}$ e16x  $\phi 15 \times 12 \text{ mm}$ #16 r11x  z1**10**36x  l15x  56x56/20 mm k5210x  $\phi 4 \times 30 \text{ mm}$ p21

11

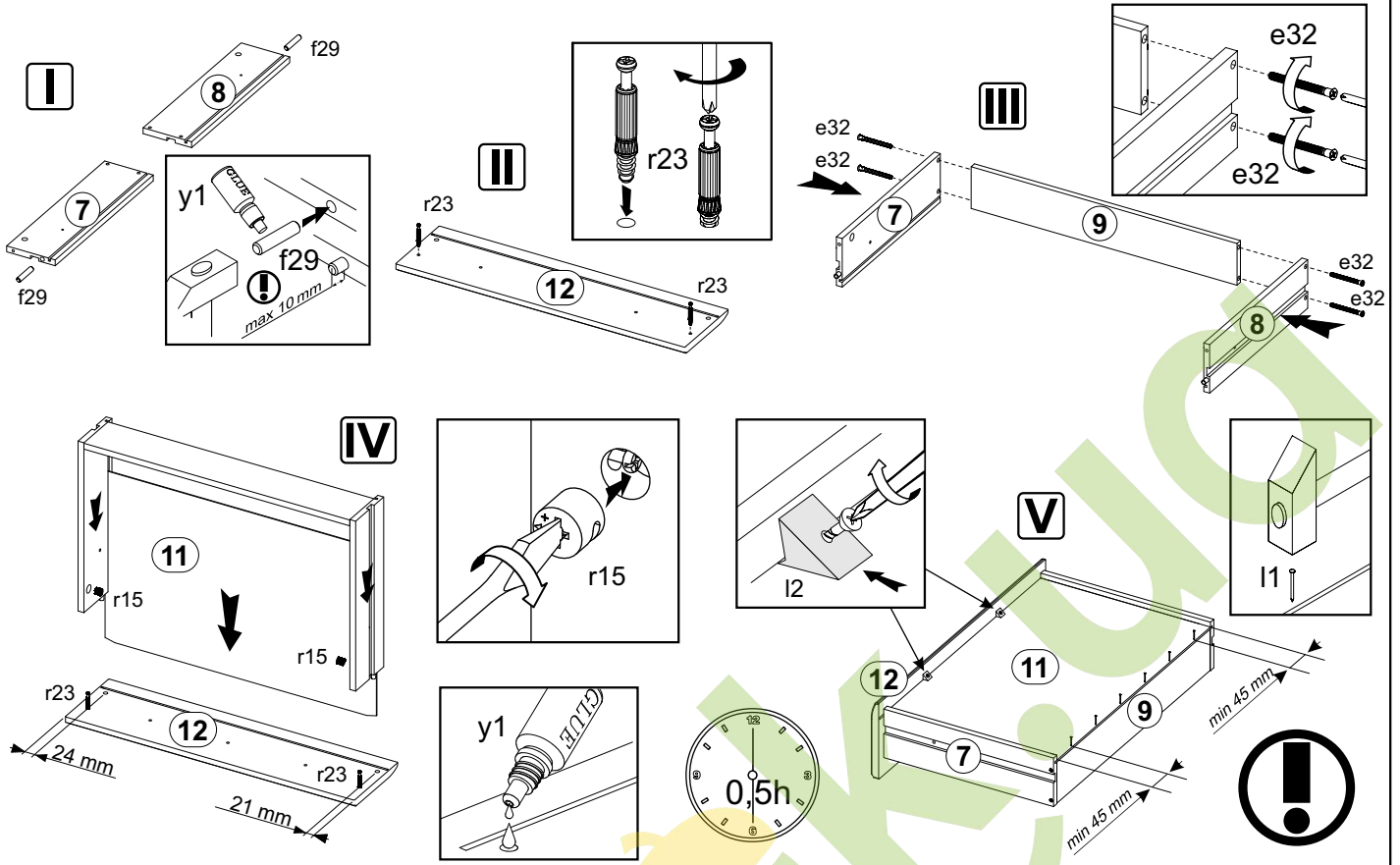
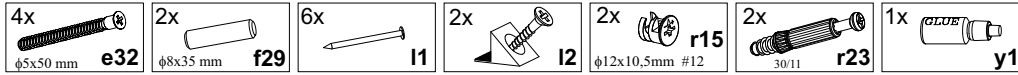

12

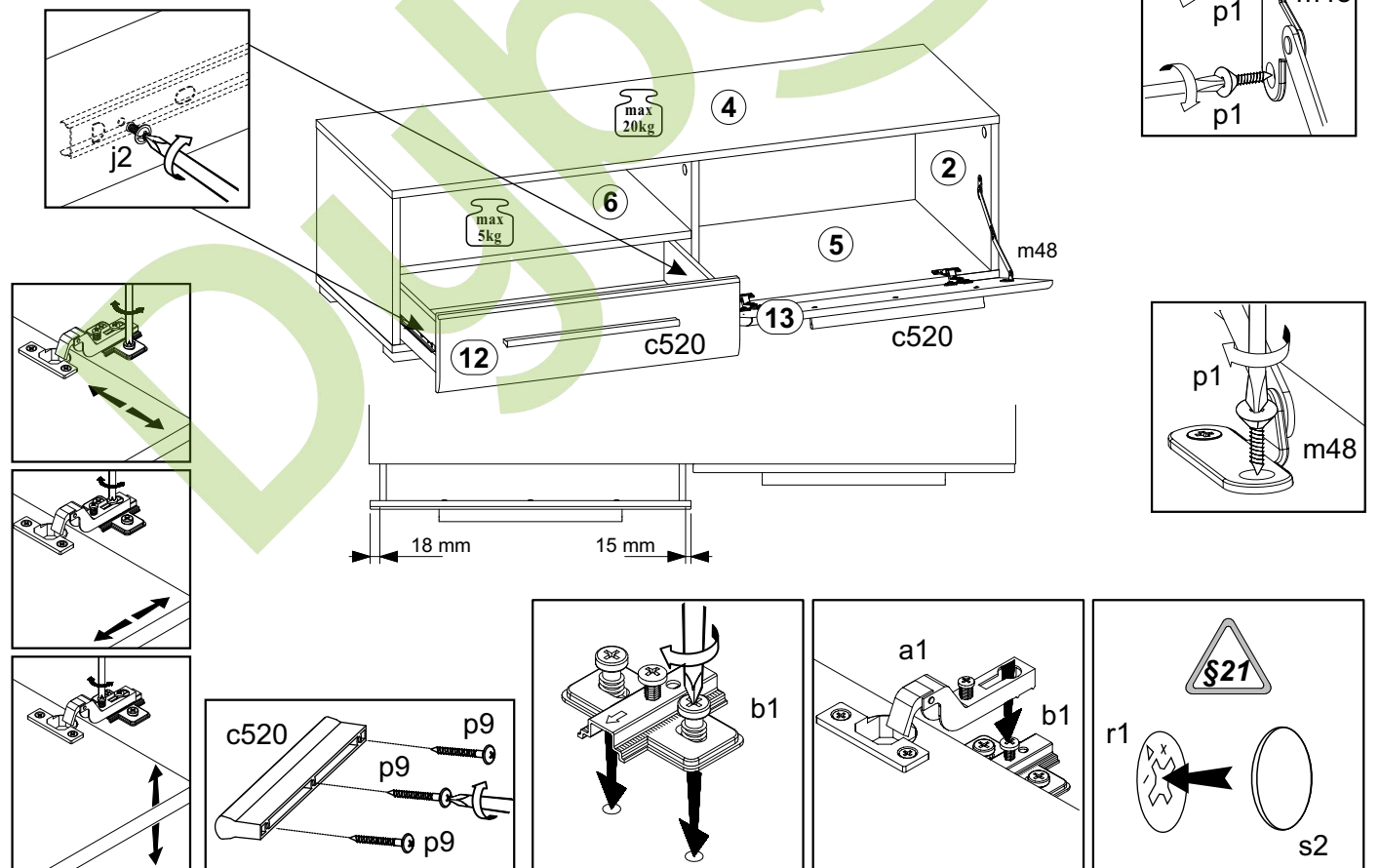
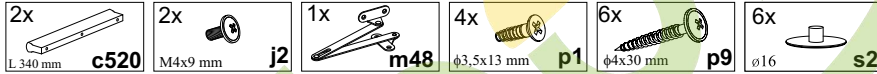



Вітрина навісна ліва / Витрина навесная левая

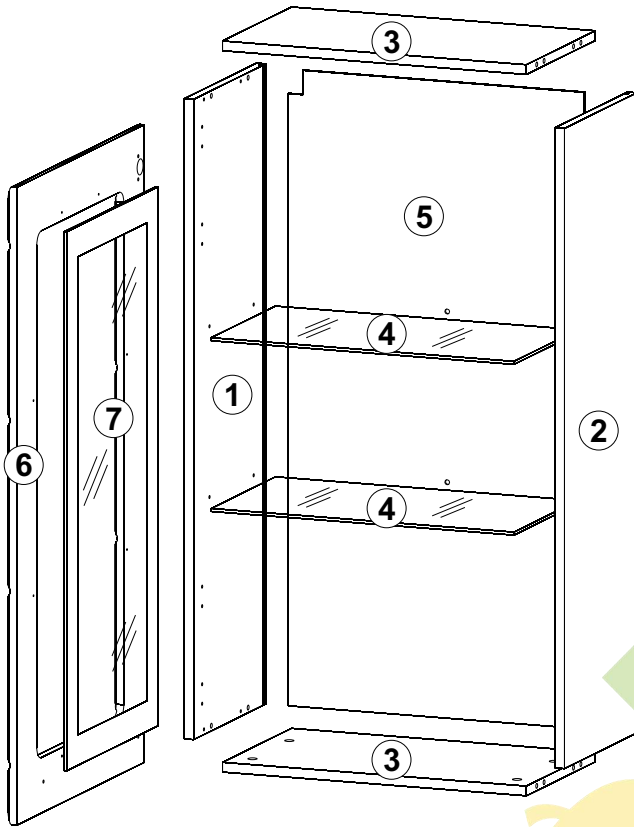

A	B	C	D	
1	PU1-113-01	1050	314	3/4
2	PU1-108-01	1050	314	3/4
3	PU1-309	568	300	3/4
4	PU1-310	565	279	3/4
5	PU1-912	1044	579	4/4
6	PU1-012A	1046	596	4/4
7	PU1-501	884	398	4/4

13

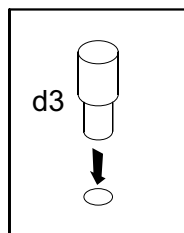
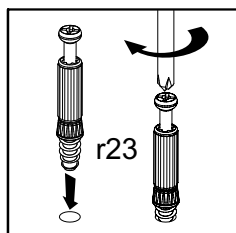
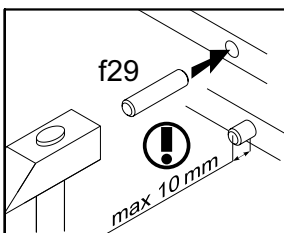
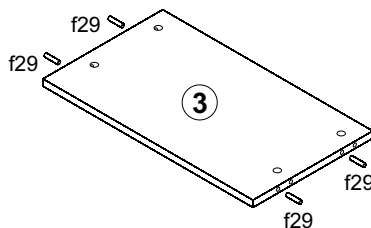
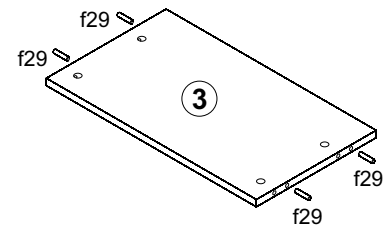
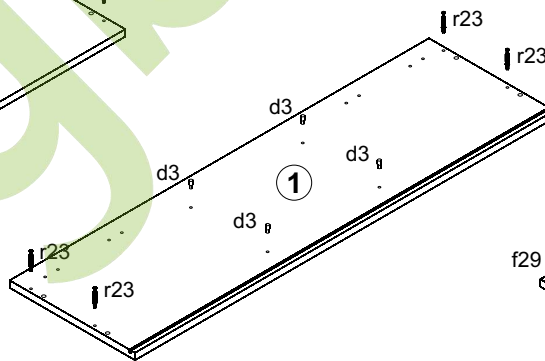
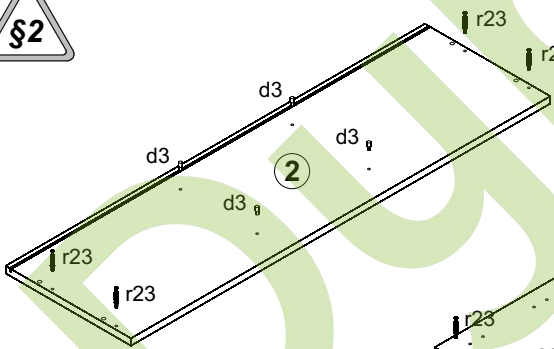
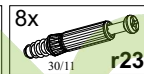
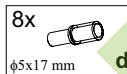
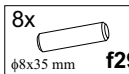

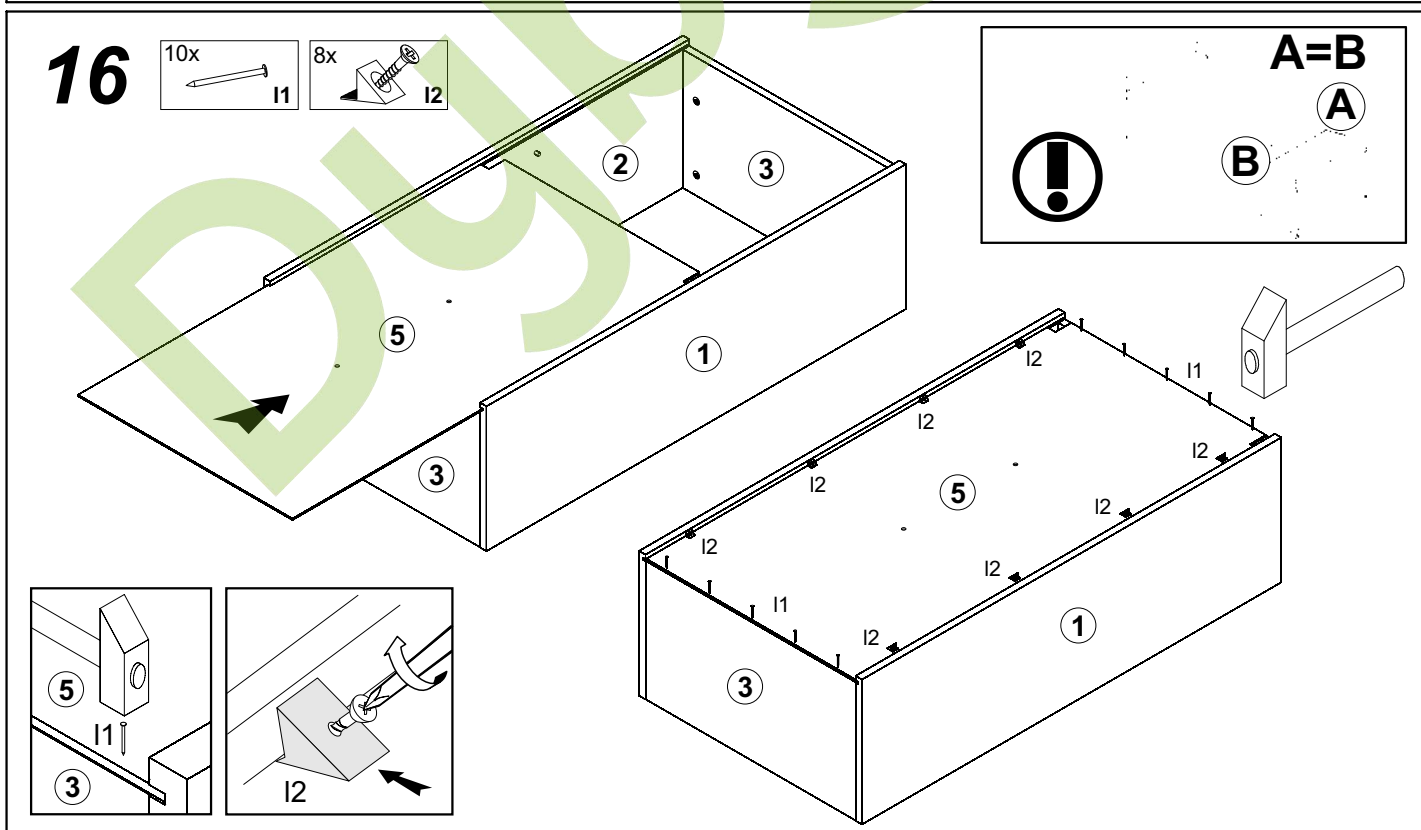
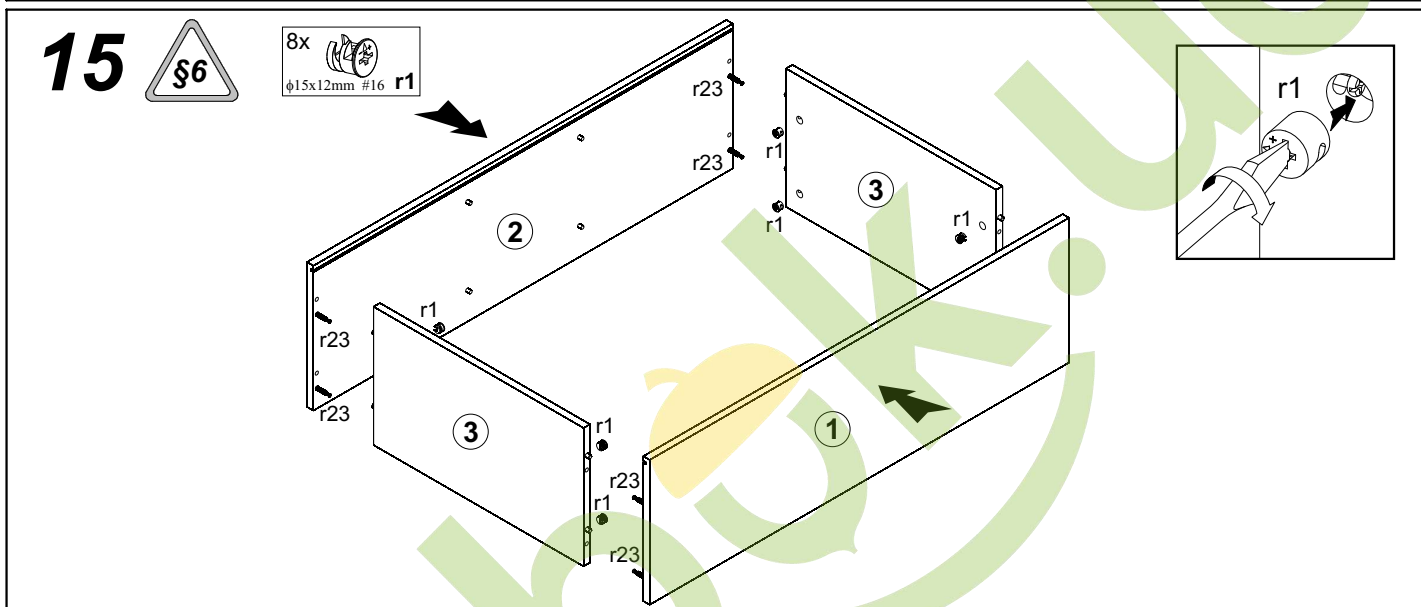
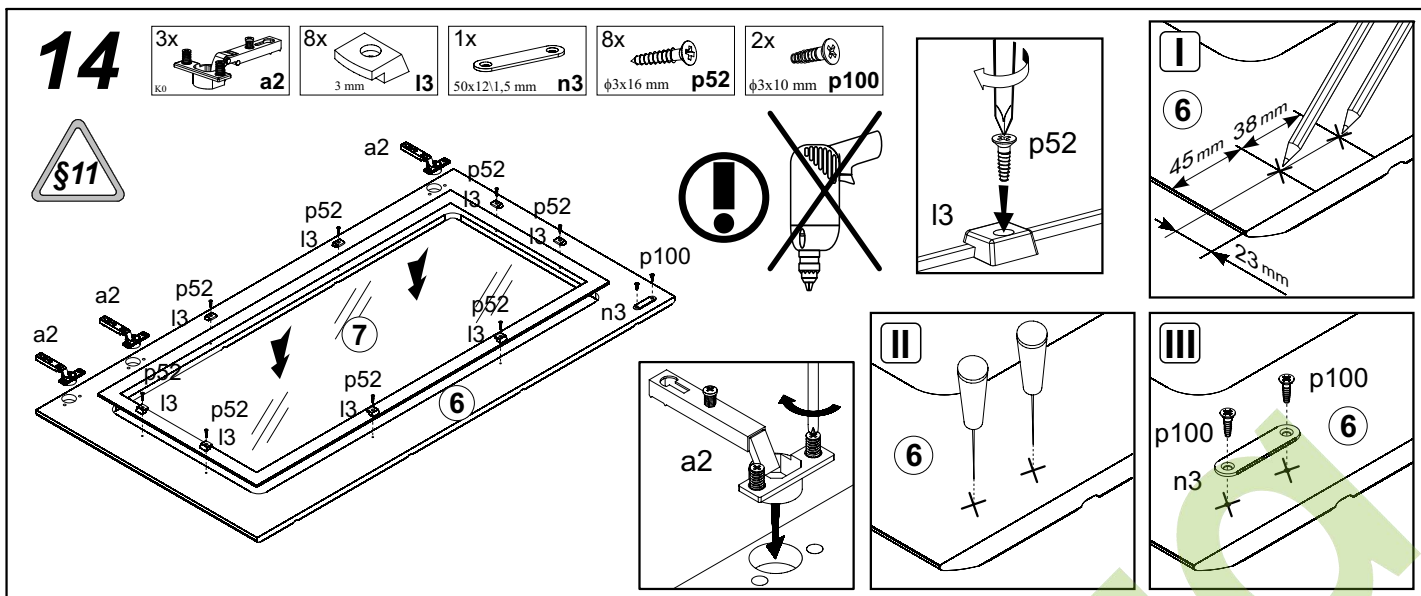

17

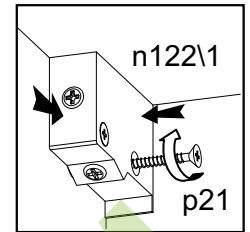
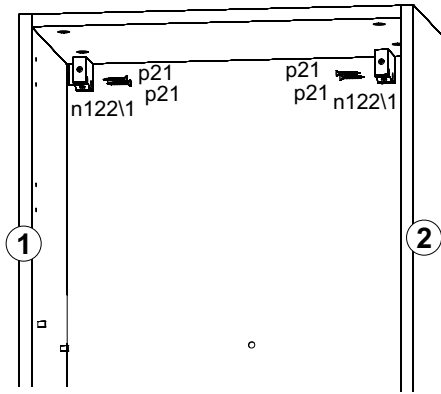
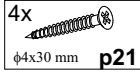
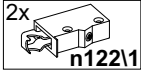

18

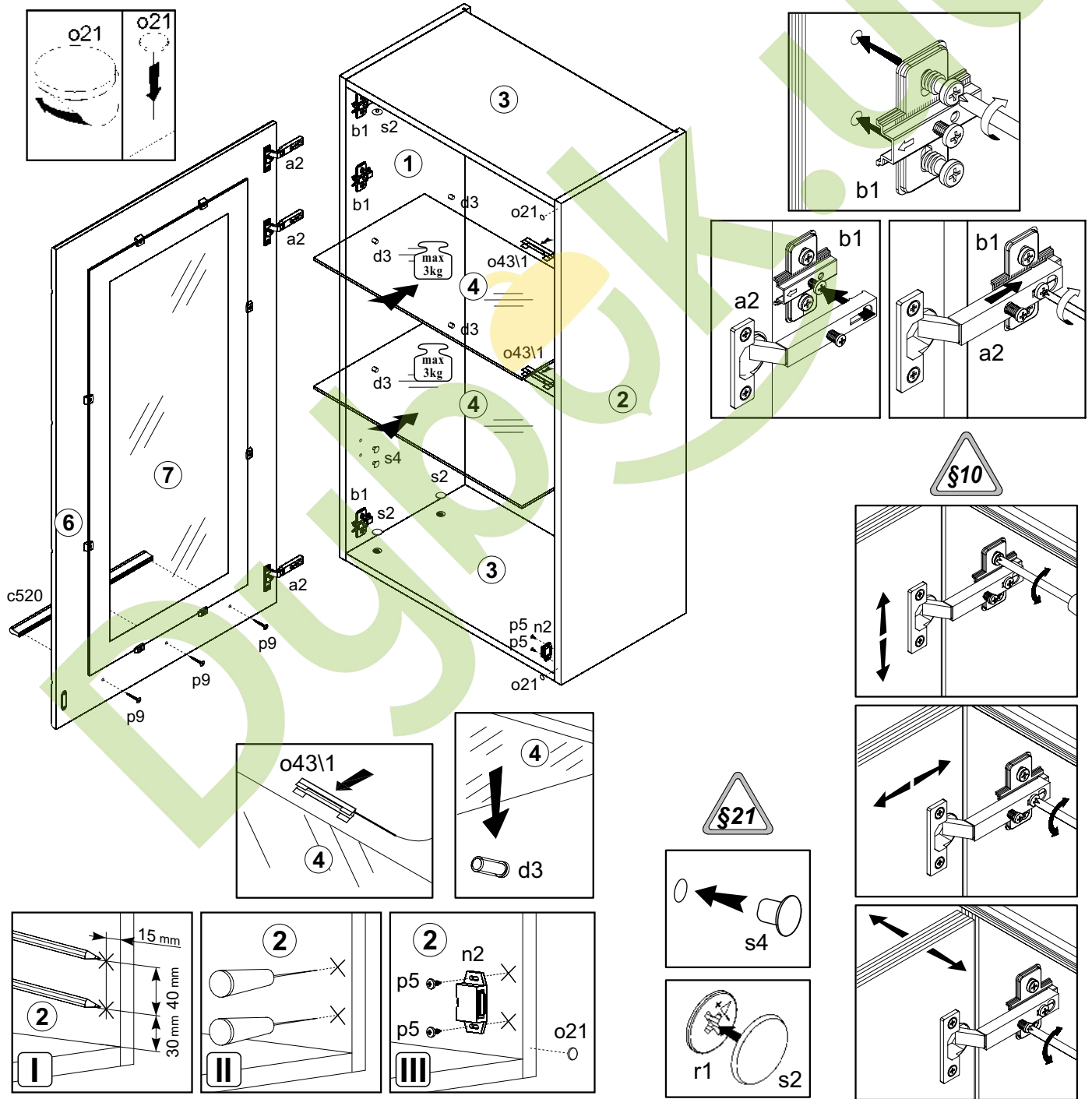
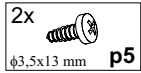
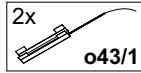
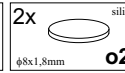
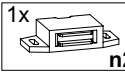
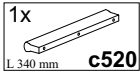

IV

Вітрина навесна права / Витрина навесная правая

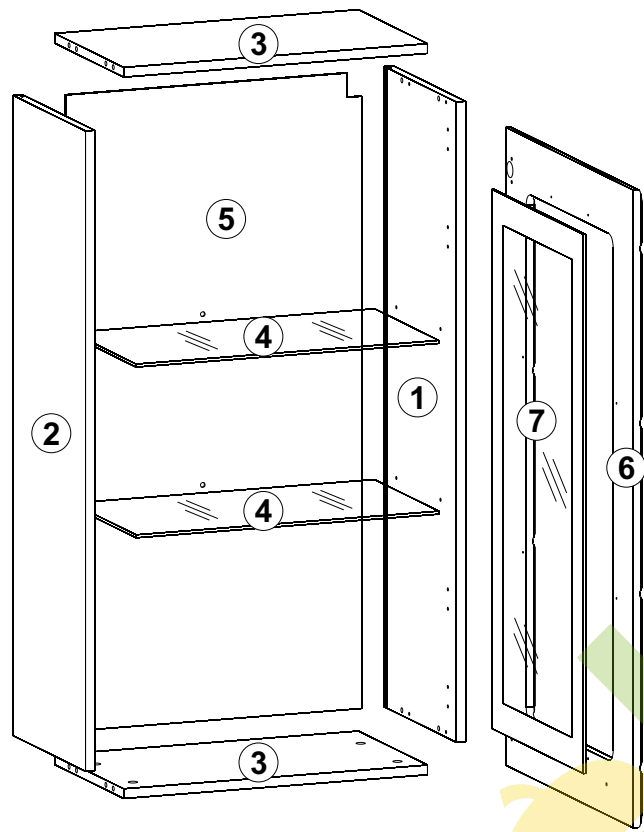

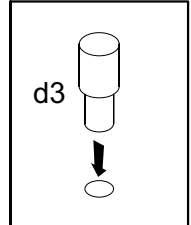
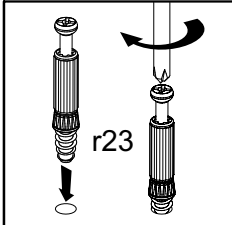
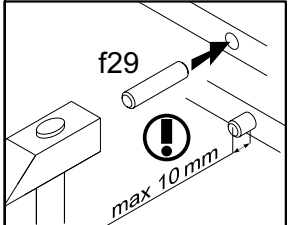
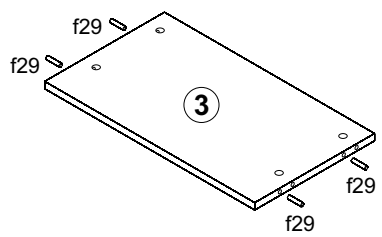
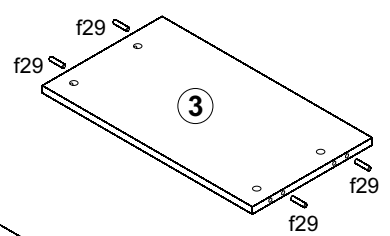
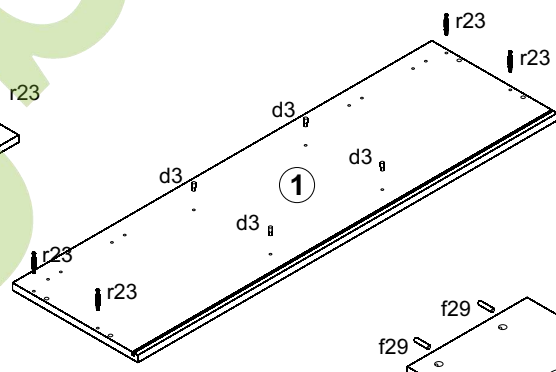
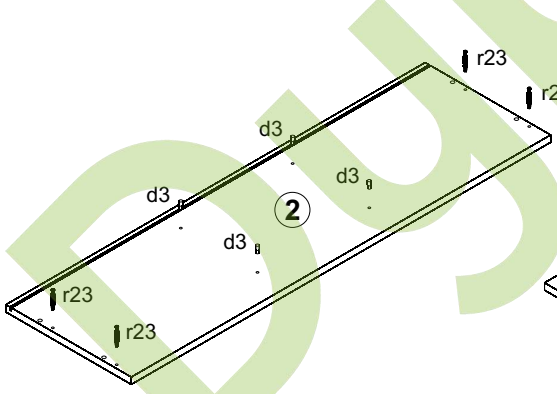
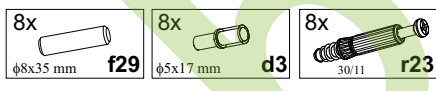

A	B	C	D
1	PU1-113-01	1050	314 3/4
2	PU1-108-01	1050	314 3/4
3	PU1-309	568	300 3/4
4	PU1-310	565	279 3/4
5	PU1-912	1044	579 4/4
6	PU1-013A	1046	596 4/4
7	PU1-501	884	398 4/4

19

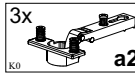
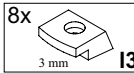
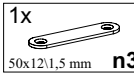
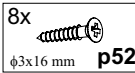

20

- 3x  a2
- 8x  l3 3 mm
- 1x  n3 50x12/1,5 mm
- 8x  p52 $\phi 3 \times 16$ mm
- 2x  p100 $\phi 3 \times 10$ mm

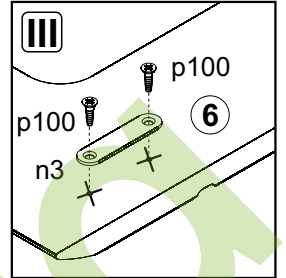
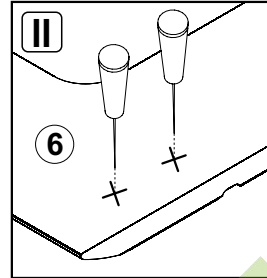
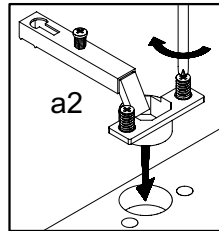
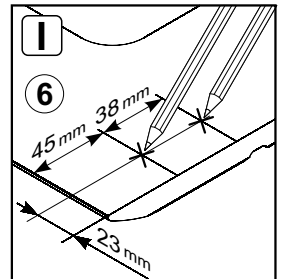
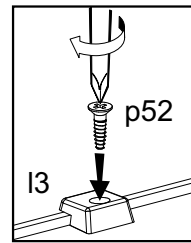
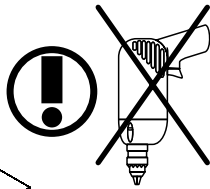
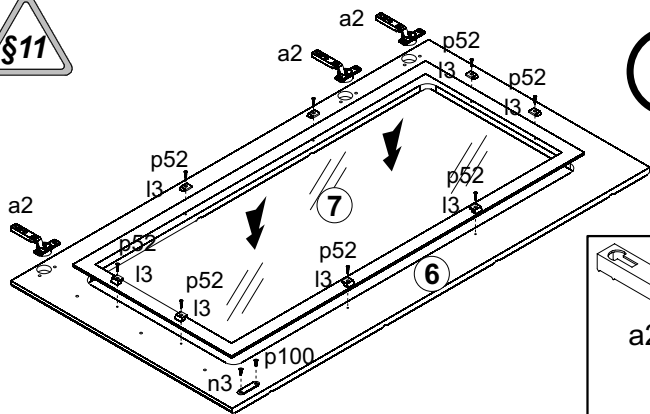

21



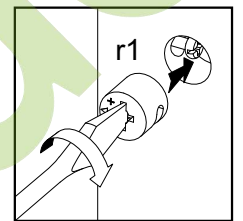
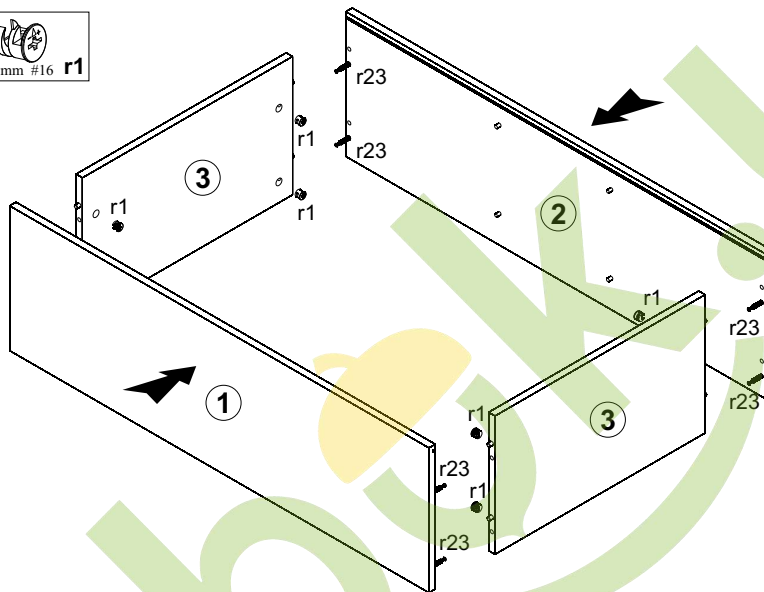

- 8x  r1 $\phi 15 \times 12$ mm #16

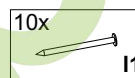

A=B

22

- 10x  l1
- 8x  l2



B

A

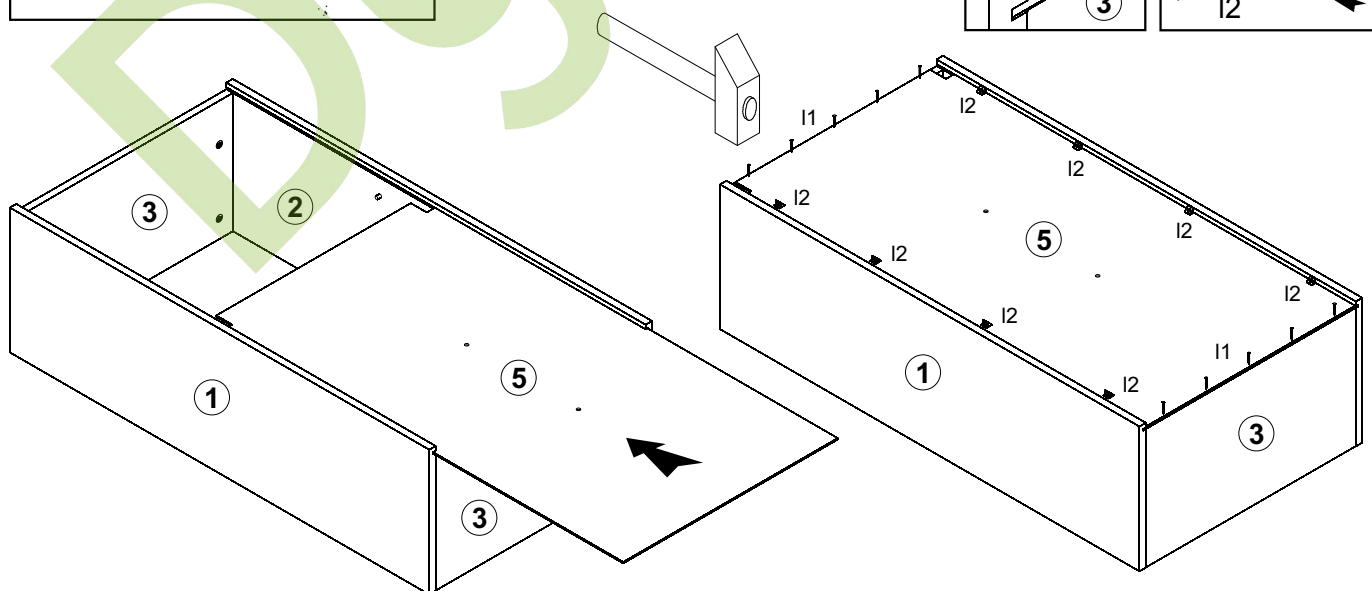
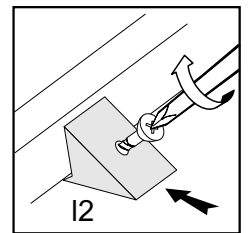
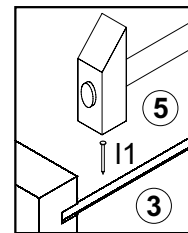

23

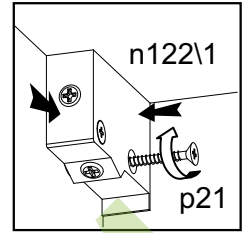
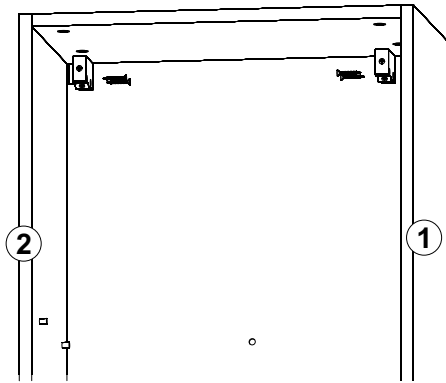
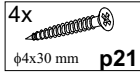
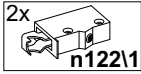

24

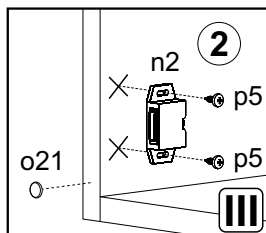
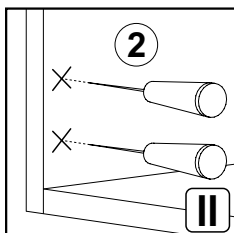
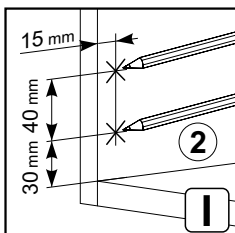
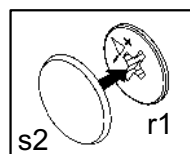
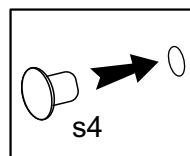
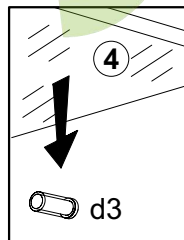
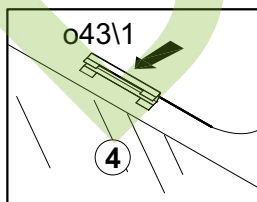
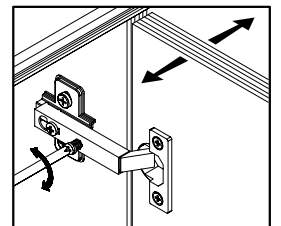
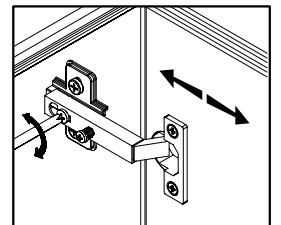
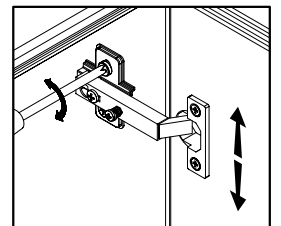
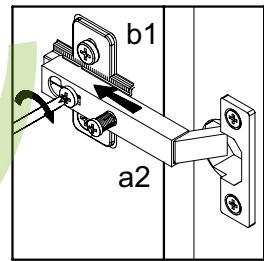
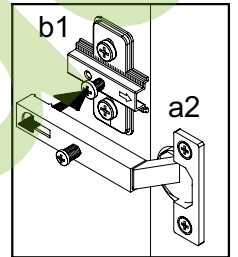
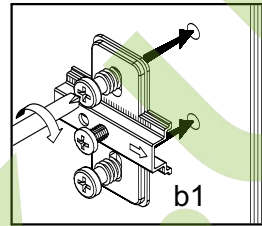
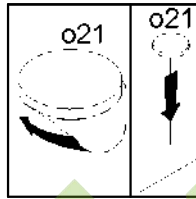
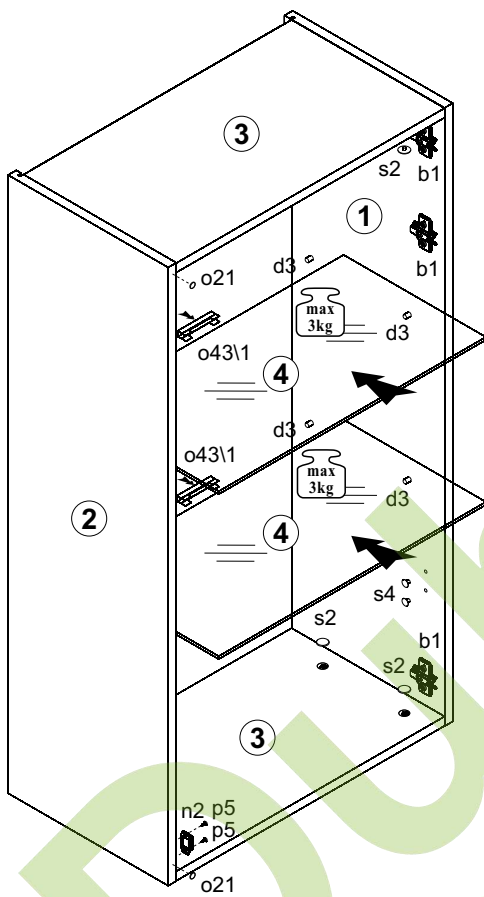
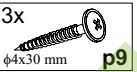
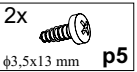
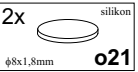
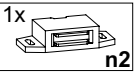
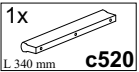

V Полиця / Полка

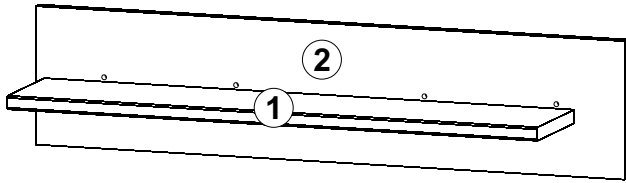

A	B	C	D
1	PU1-306	900	180
2	PU1-401	225	1000



25

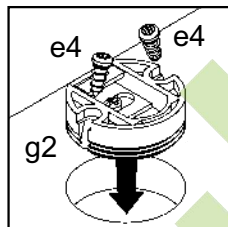
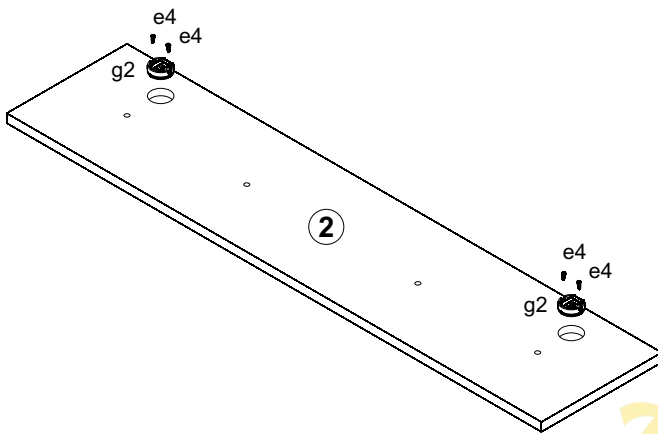
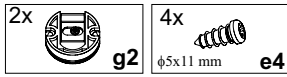

26

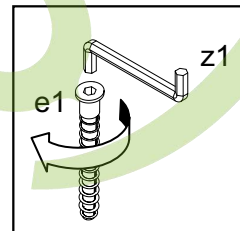
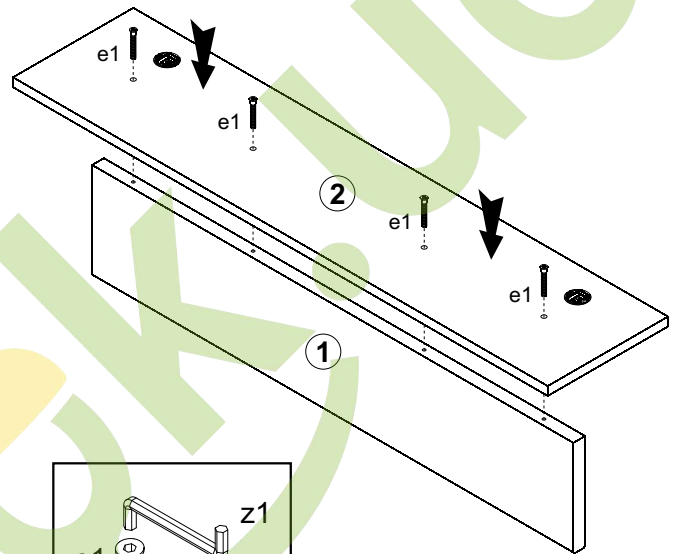

27

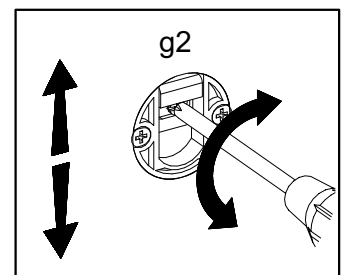
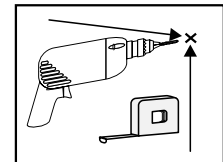
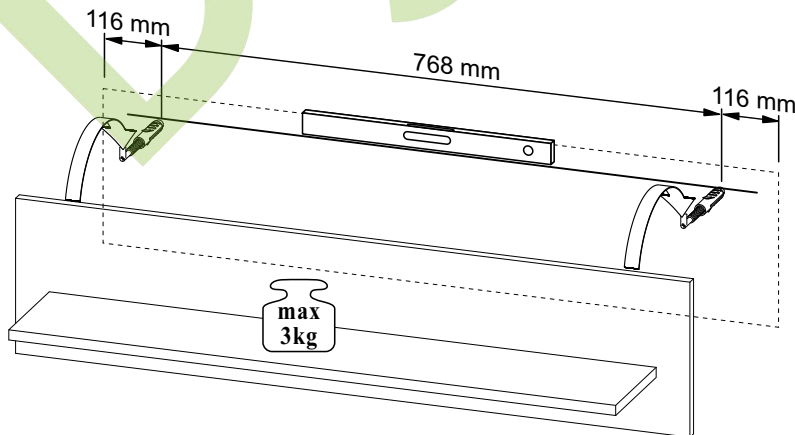
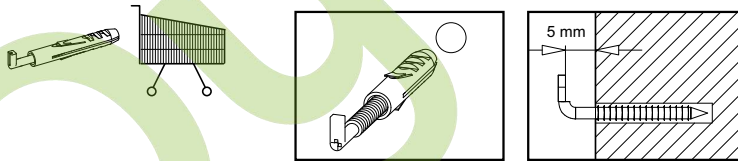

28

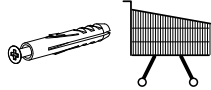
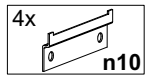

25 mm

64 mm

64 mm

25 mm

