

| A | B | C | D |
|----|----------|------|----------|
| 1 | S314-118 | 1942 | 540 1/3 |
| 2 | S314-119 | 1942 | 540 1/3 |
| 3 | S314-911 | 1969 | 446 1/3 |
| 4 | LH-1941 | 1941 | 14 1/3 |
| 5 | S314-211 | 900 | 540 2/3 |
| 6 | S314-212 | 900 | 540 2/3 |
| 7 | S314-305 | 867 | 540 2/3 |
| 8 | S314-406 | 867 | 160 2/3 |
| 9 | S314-575 | 867 | 80 2/3 |
| 10 | DR-862 | 862 | 2/3 |
| 11 | S314-023 | 446 | 468 3/3 |
| 12 | S314-024 | 446 | 468 3/3 |
| 13 | S314-025 | 446 | 1500 3/3 |
| 14 | S314-026 | 446 | 1500 3/3 |

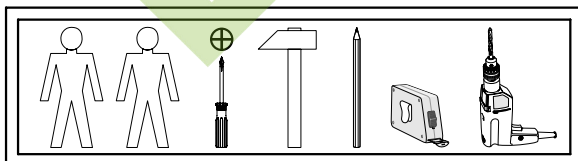

| | | | | | | | |
|-------------------------|------------------------|--------------------------|---------------------------|-----------------------------|----------------------|------------------|-----------------|
| 10x a44 | 10x b19 | 6x φ7x50 mm e1 | 18x φ8x30 mm f1 | 4x 84x40/25 mm k77 | 70x l1 | 2x n1 | 1x n26\1 |
| 2x φ3,5x13 mm p1 | 8x φ4x25 mm p36 | 7x φ3,5x16 mm p38 | 20x φ3,5x15 mm p51 | 18x φ15x12 mm #16 r1 | 18x 20/11 r42 | 6x φ16 s2 | 1x z1 |

1

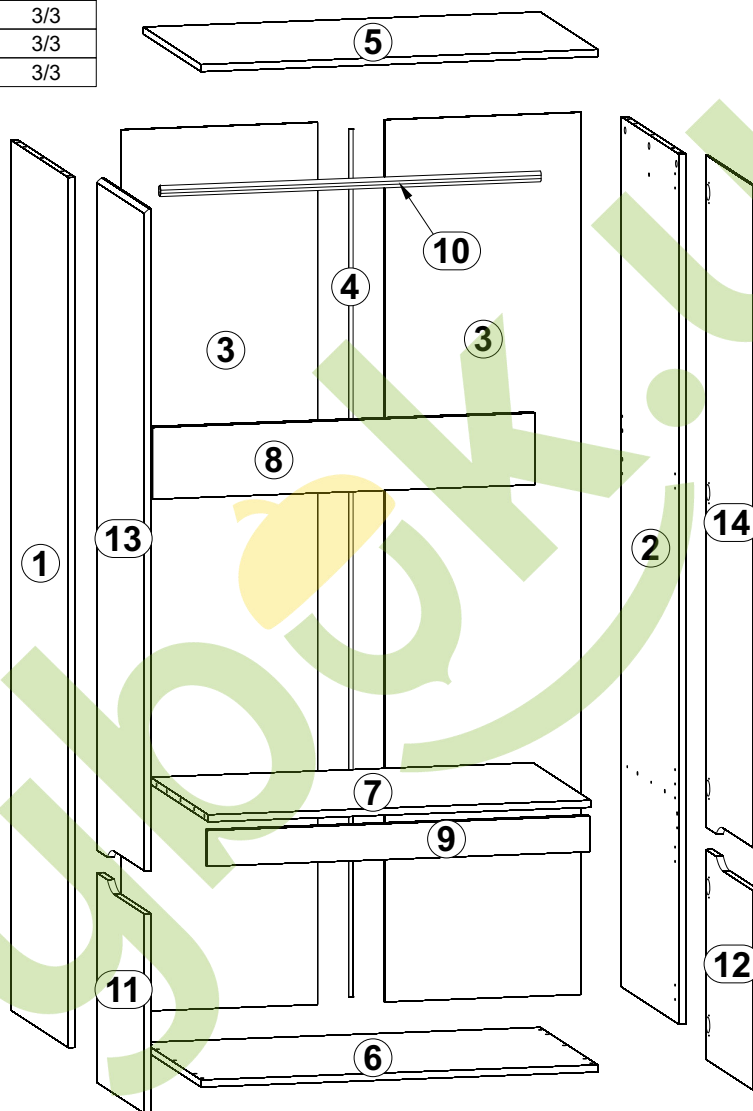
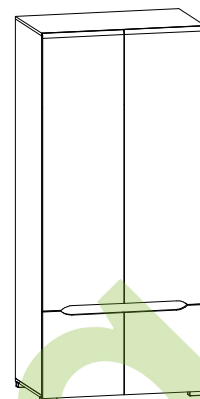
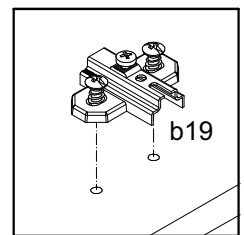
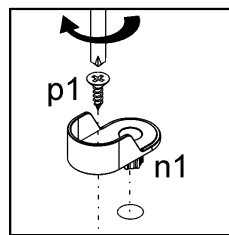
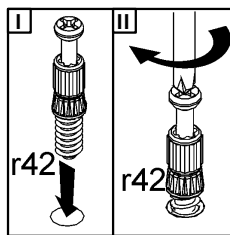
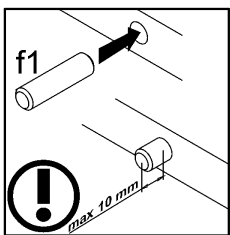
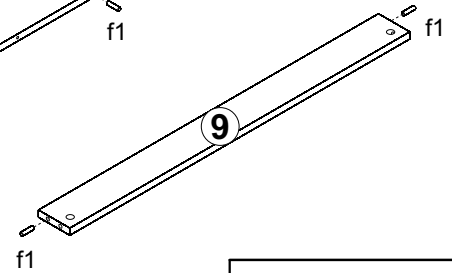
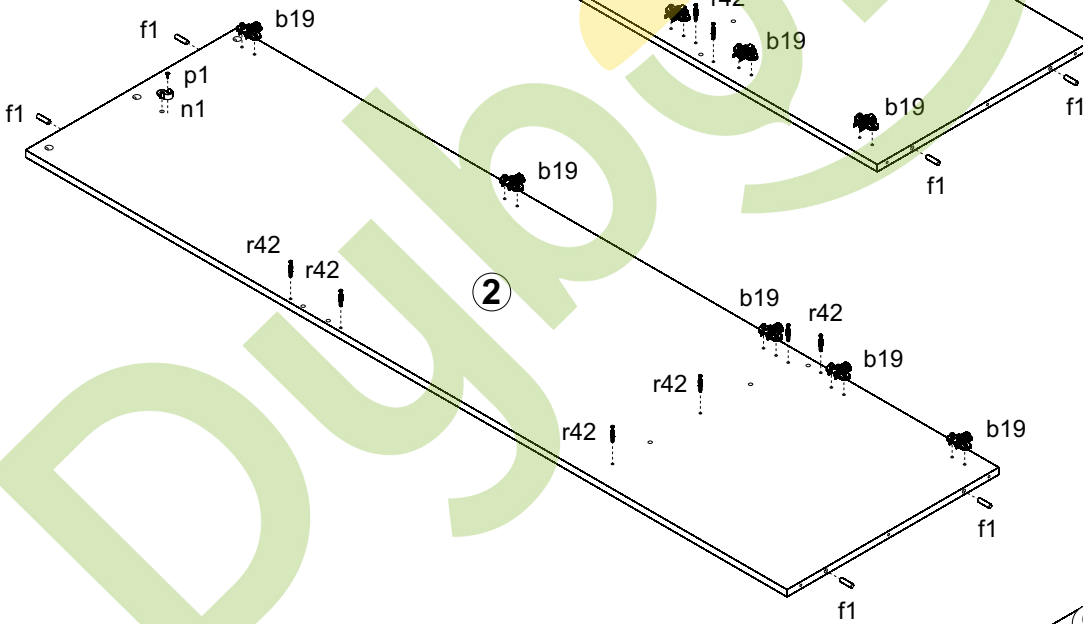
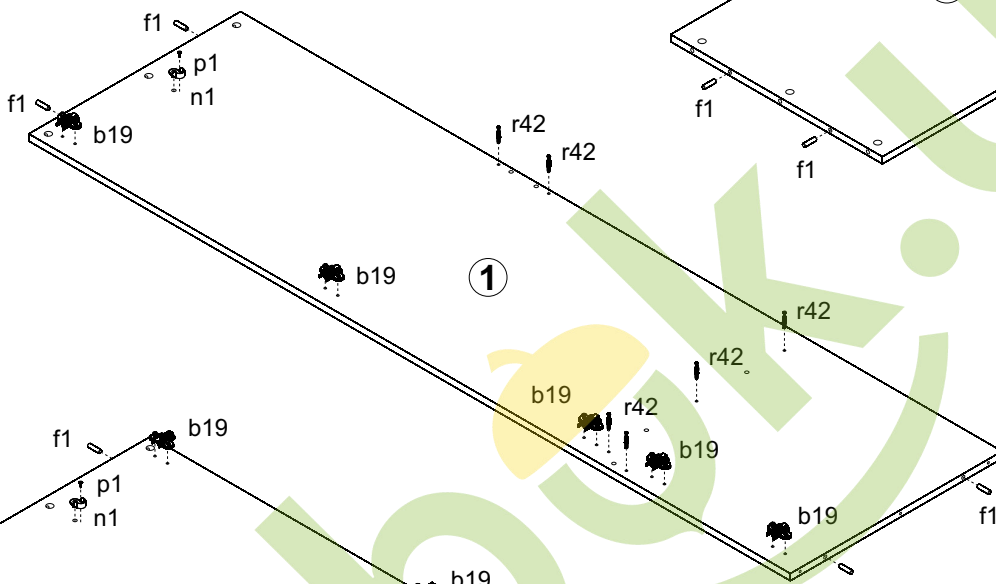
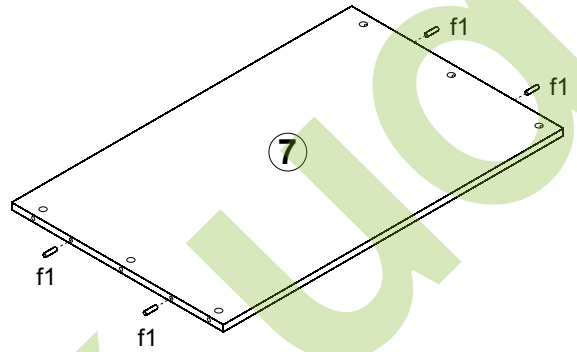
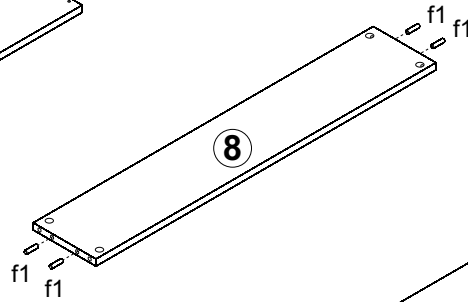
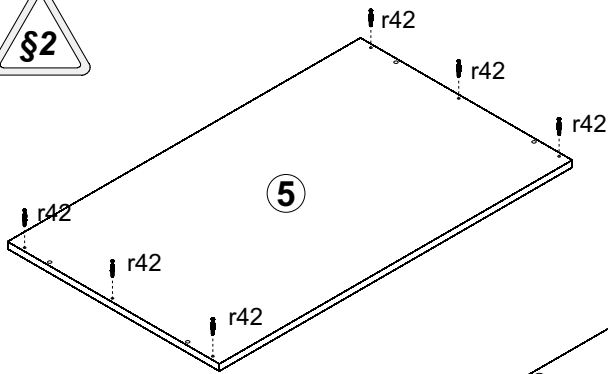

2 

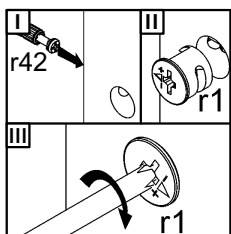
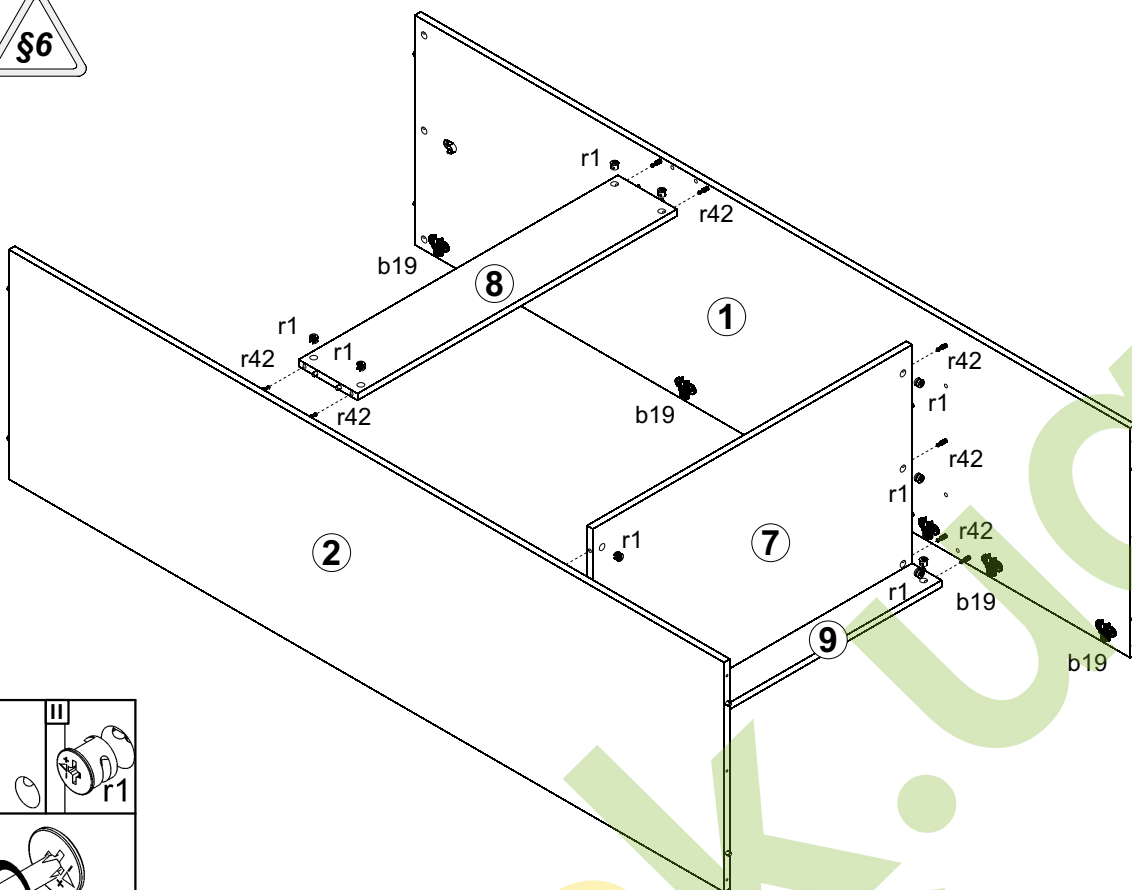

3

