

A	B	C	D	A	B	C	D	A	B	C	D			
1	S322-0027	895	240	4/5	7	S322-1142	248	516	1/5	13	S322-9933	865	505	1/5
2	S322-0028	895	240	4/5	8	S322-1143	1716	518	1/5	14	S322-9935	2017	455	1/5
3	S322-0029	1708	446	5/5	9	S322-2214	1883	551	2/5	15	ZB-5512	835	200	3/5
4	S322-0030	1708	446	5/5	10	S322-3326	1799	537	2/5	16	BB-505	500	200	3/5
5	S322-1140	2060	540	1/5	11	S322-3327	1799	537	2/5	17	BB-506	500	200	3/5
6	S322-1141	2060	540	1/5	12	S322-3328	891.5	517	1/5	18	dr-887	887	22	2/5
										19	Lh-1977	1977	14	1/5

A	B	C	D	
20	S322-329	890.5	513	1/1

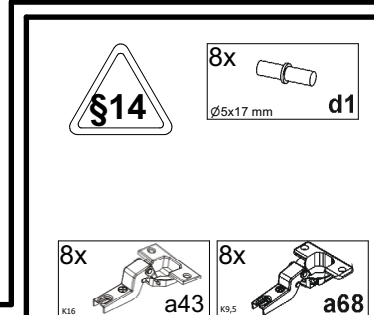
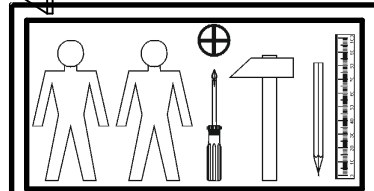
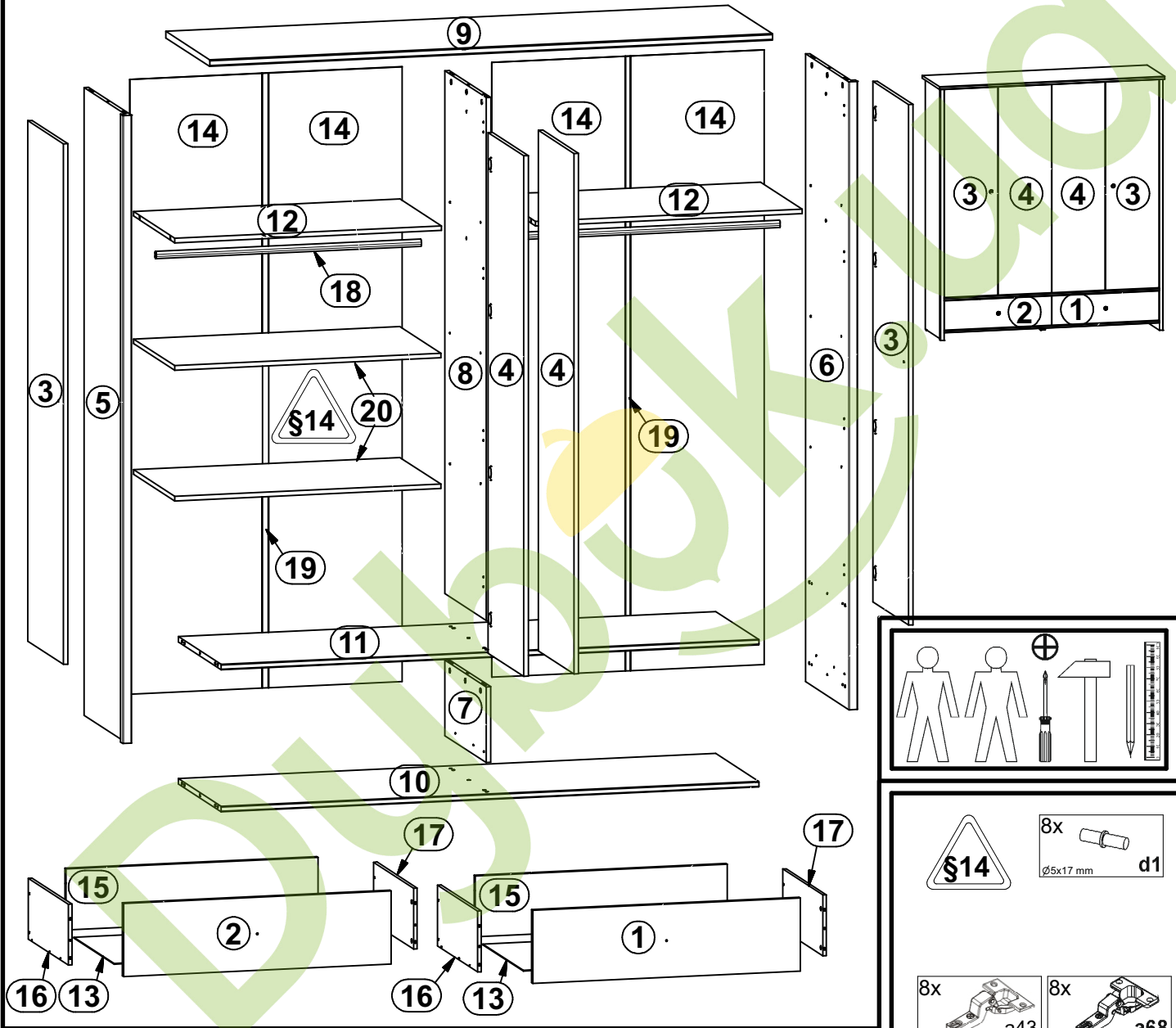

8x  b19	8x  b33	4x  c415	6x  e1	1x  e2	9x  e3	12x  e19	24x  f1	2x  p25
8x  f25	4x  j1	4x  k1	1x  k38\13	1x  k38\8	160x  l1	4x  n1	4x  o21	4x  p1
2x  p35	16x  p38	32x  p51	3x  p54	32x  r1	8x  r37	8x  r36	32x  r42	9x  s2
2x  t34	2x  w26\CL	2x  w26\CR	2x  w26\DL	2x  w26\DR	1x  z1			

# 1

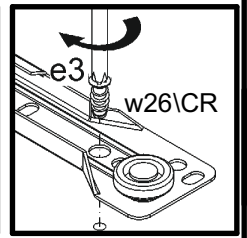
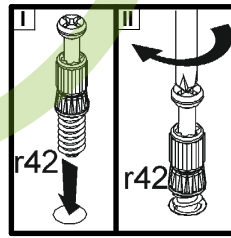
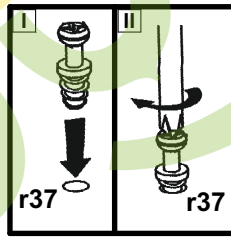
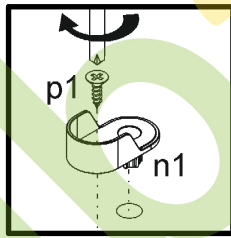
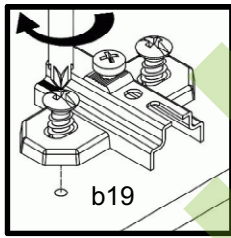
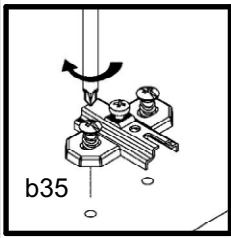
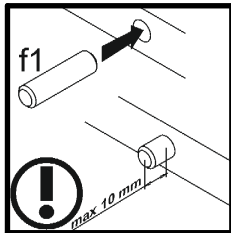
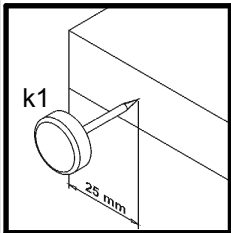
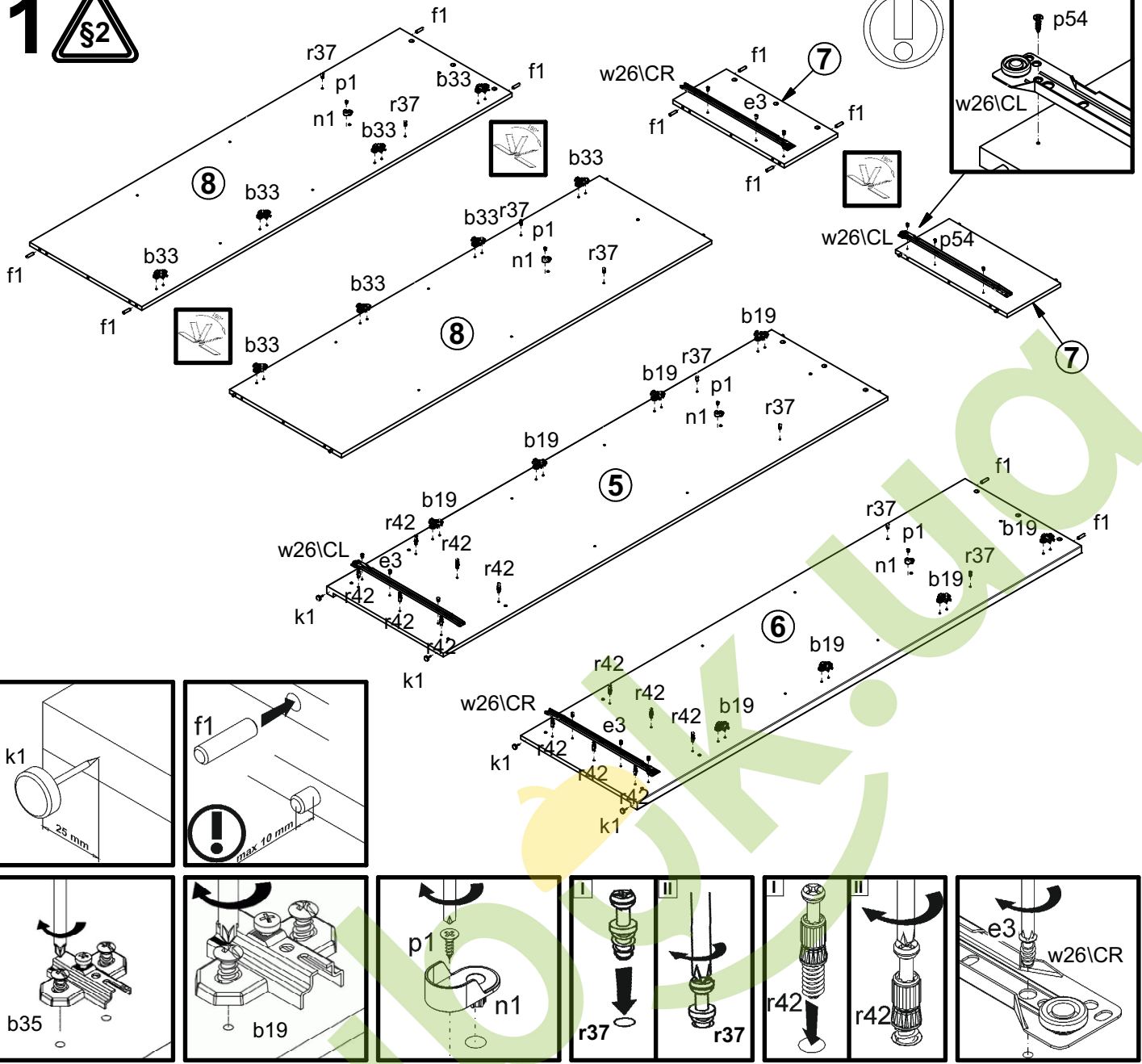

# 2

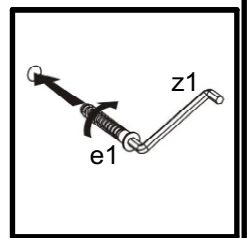
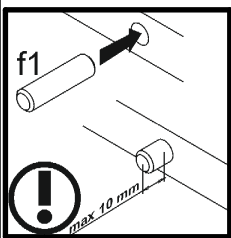
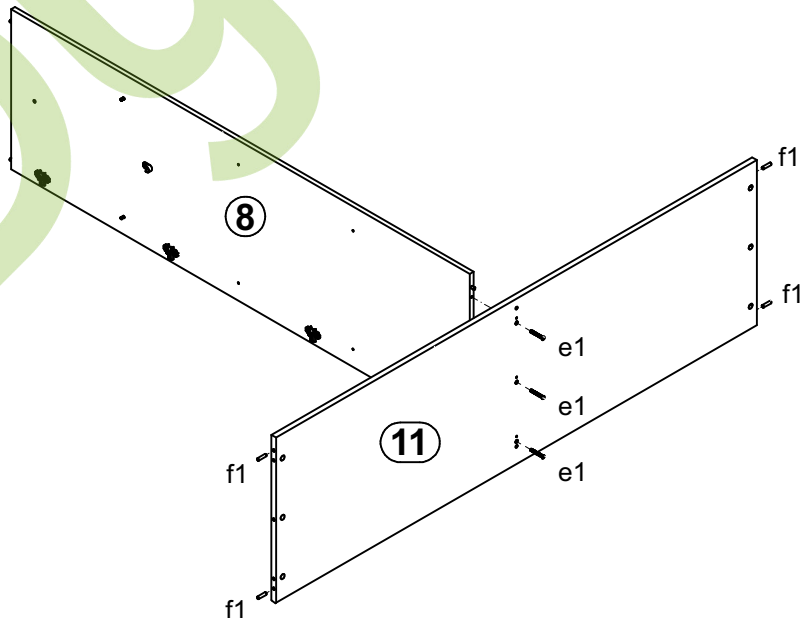

# 3

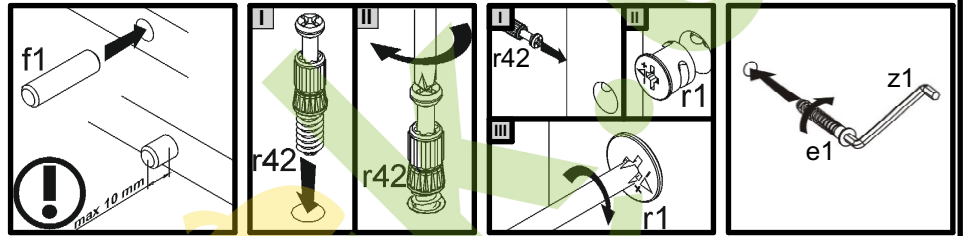
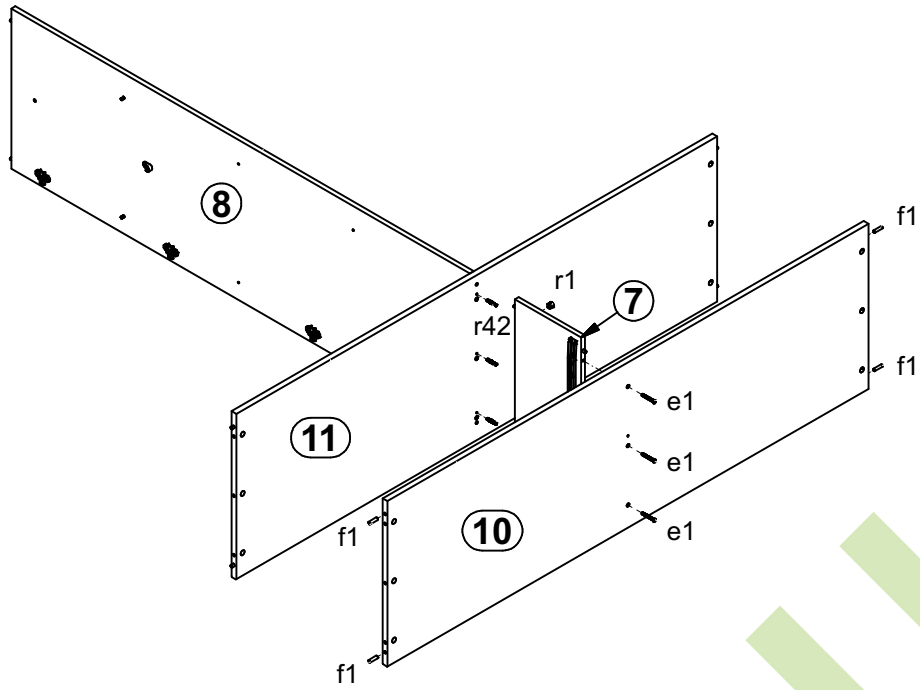

# 4

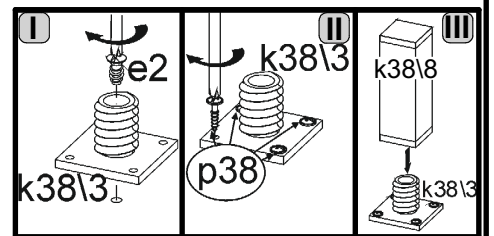
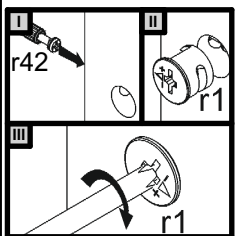
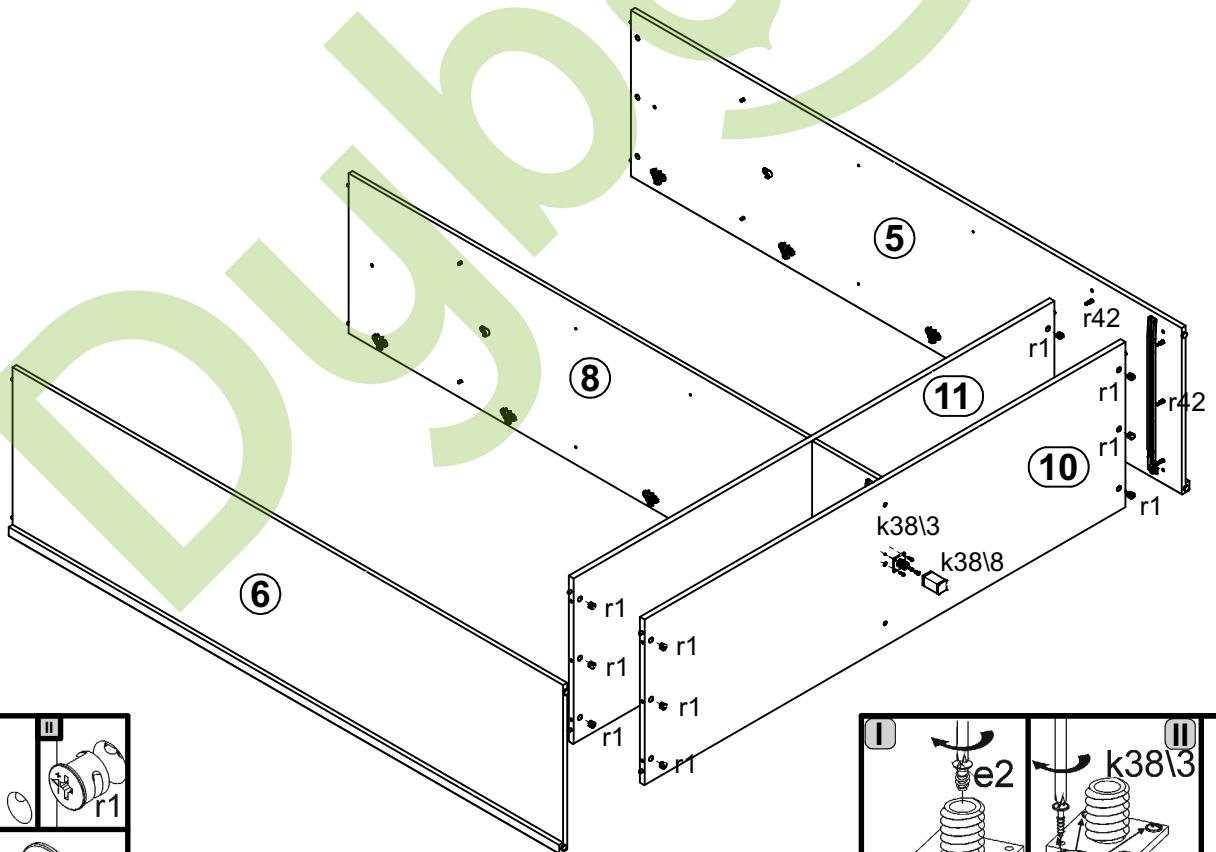

# 5

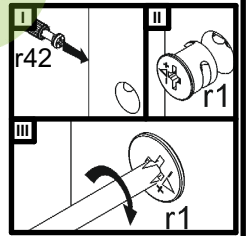
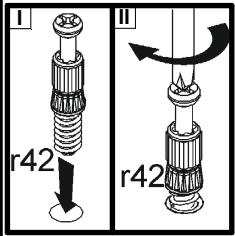
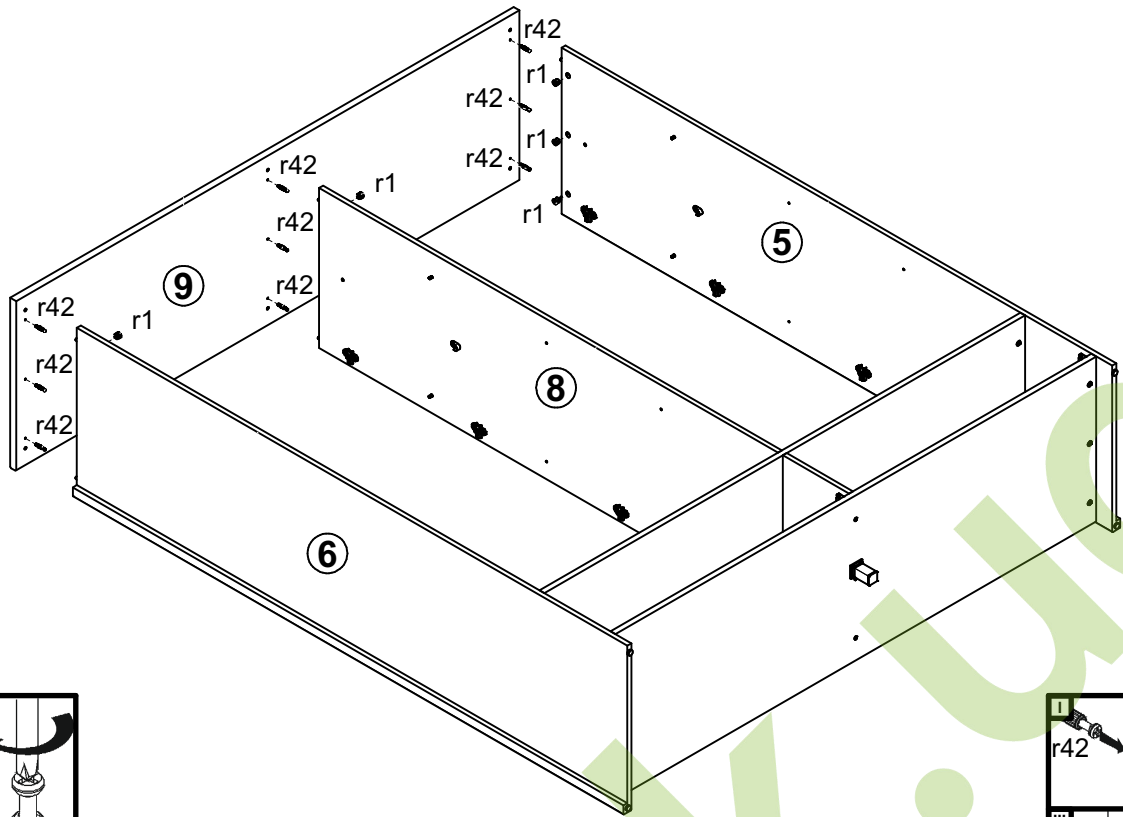

# 6

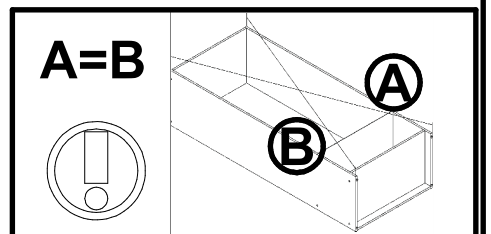
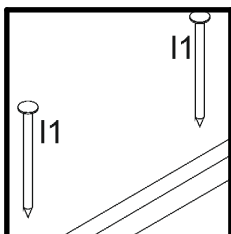
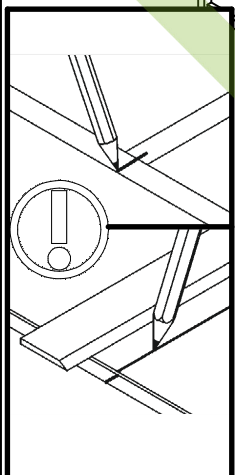
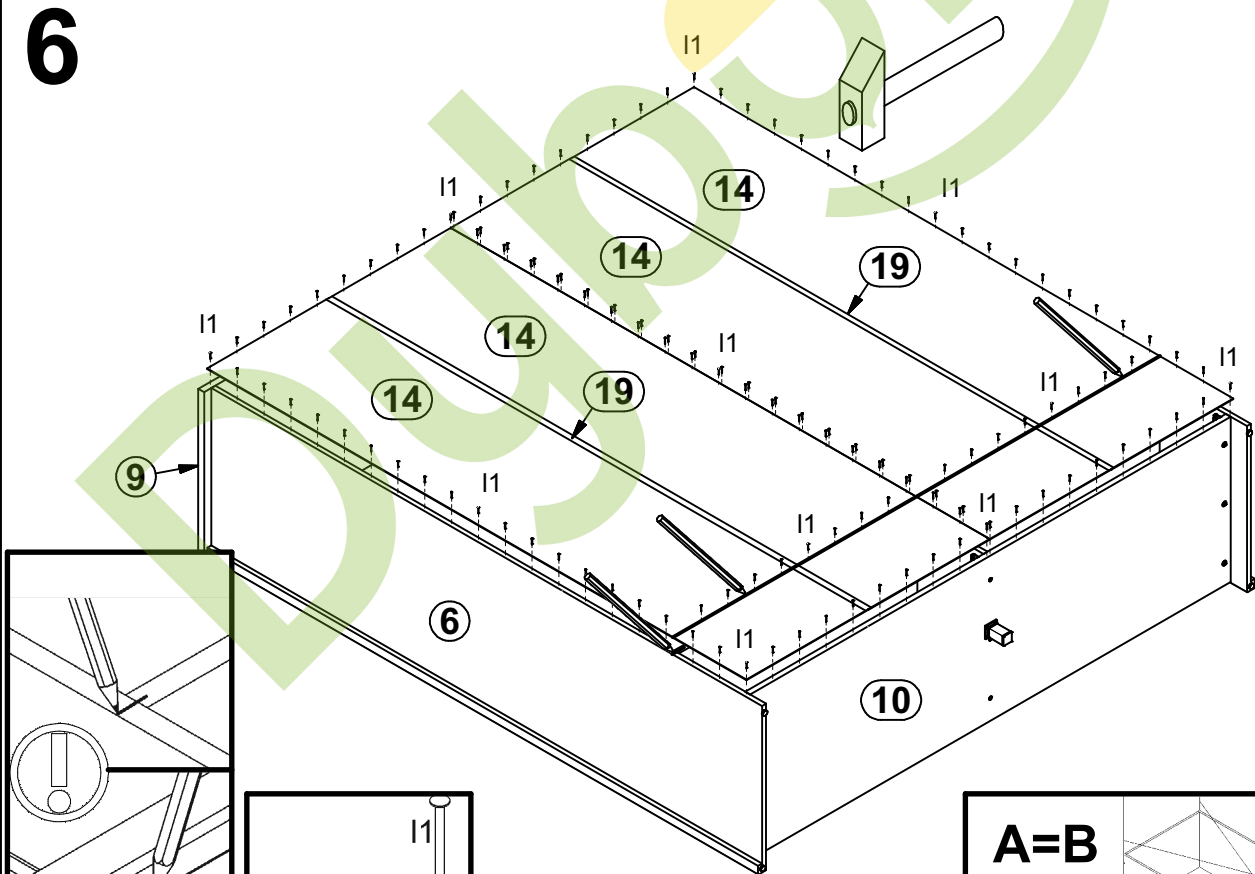

# 7

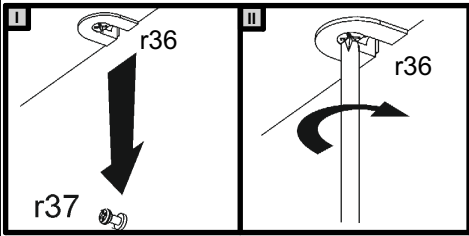
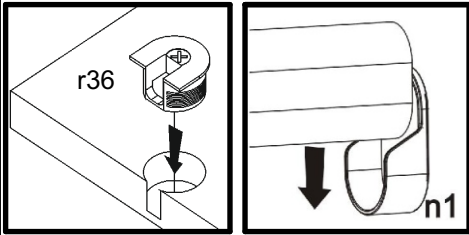
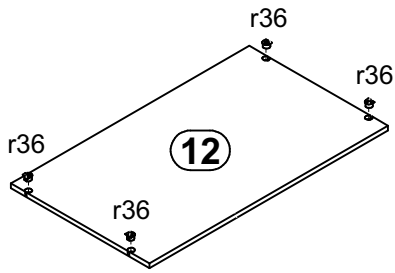

# 8

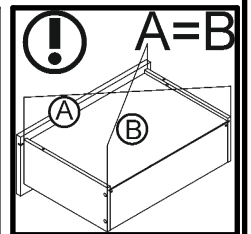
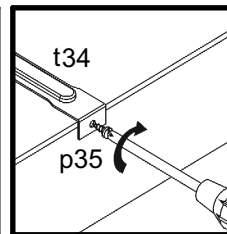
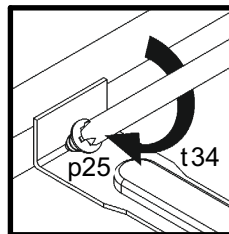
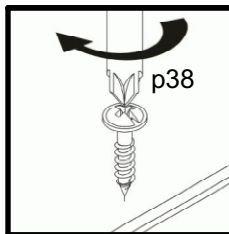
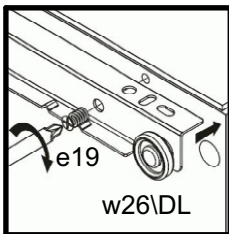
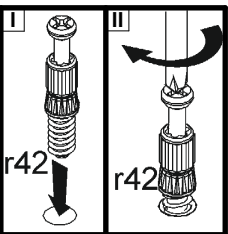
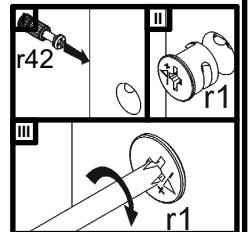
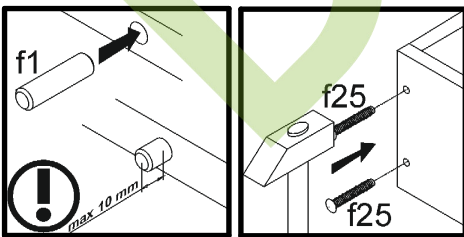
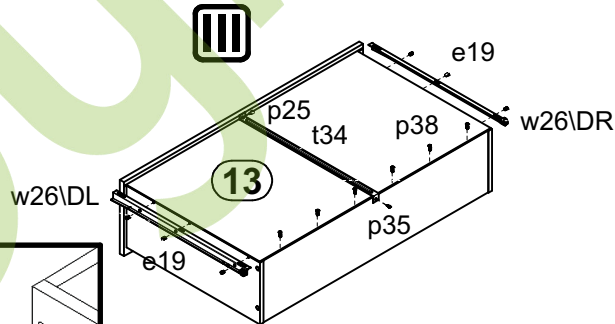
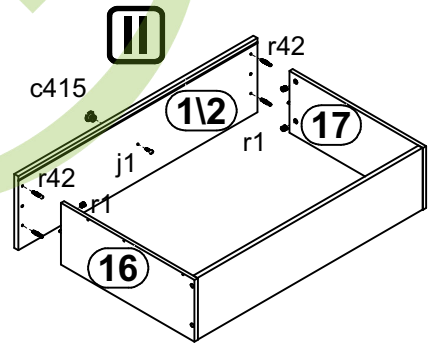
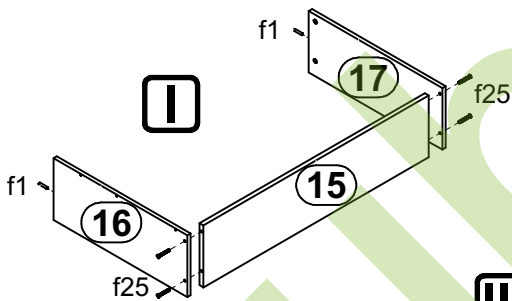

# 9

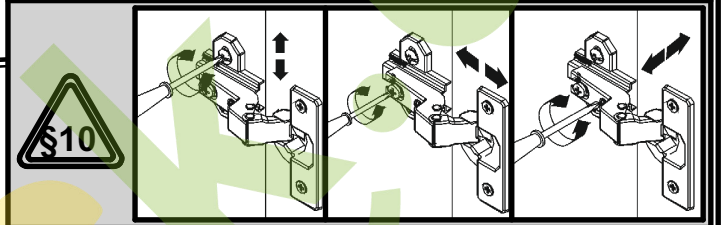
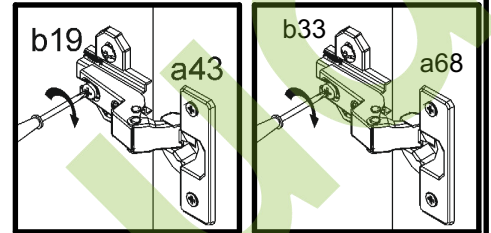
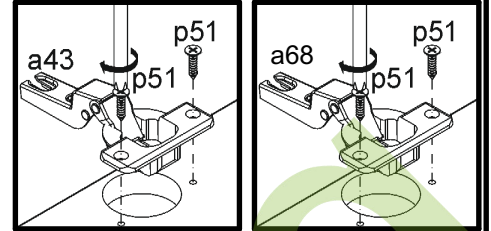
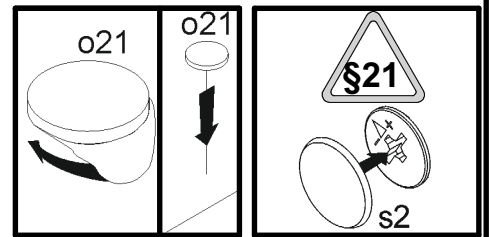
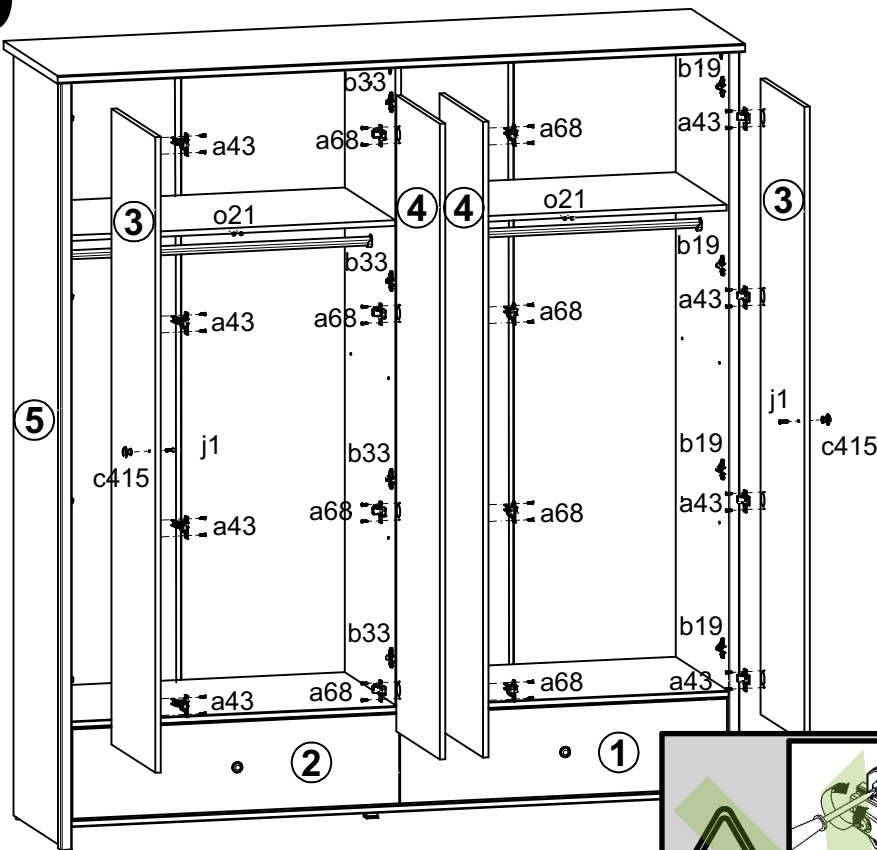

# 10

§14

