

A	B	C	D	
1	S205-046	2071	596	3/4
2	S205-165	2043	407	1/4
3	S205-167	2043	407	1/4
4	S205-169	1691	365	1/4
5	S205-168	1691	407	1/4
6	S205-166	336	407	1/4
7	S205-238	841	841	2/4
8	S205-237	841	841	2/4
9	S205-331	820	820	2/4
10	S205-332	300	360	2/4
11	S205-587	445	100	2/4
12	S205-992	2063	411	3/4
13	S205-970	2063	445	3/4
14	dr-480	480	22	2/4
15	Lh-2035	2035	14	3/4

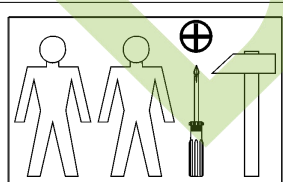

4x 45° a49	4x D1.5 b20	4x φ3.5x13 mm p1	8x φ4x35 mm p6	8x φ7x50 mm e1	4шт. n1	20x φ8x30 mm f1	2x k84	4x k85
112x l1	16x φ15x12mm #16 r1	12x 20/11 r42	1x n26	25x φ3.5x16 mm p38	8x φ3.5x15 mm p51	2x 36/20 mm r28	2x φ8x50 mm f6	16x φ5x17 mm d1
1x φ5x60 mm p17	1x φ10x50 mm f35	12x φ16 s2	1x z1	3x φ35 s33	6x φ14 s59	8x φ5 s4		

1

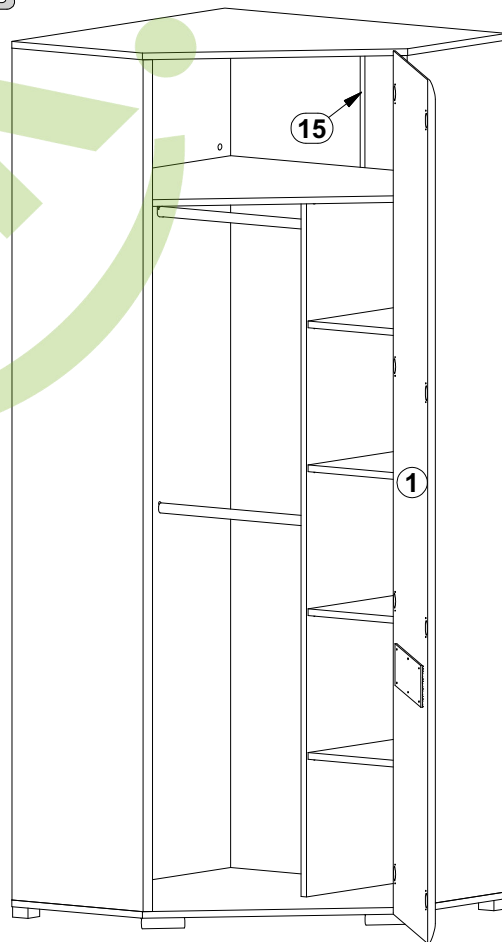
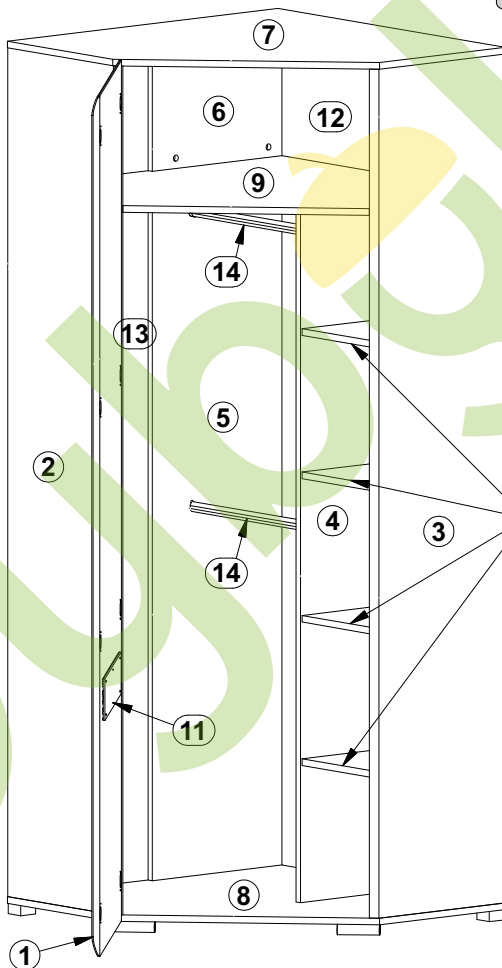
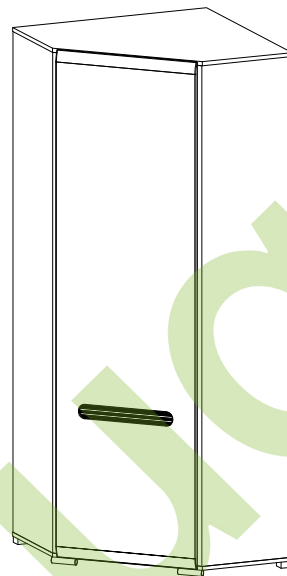
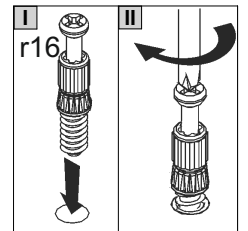
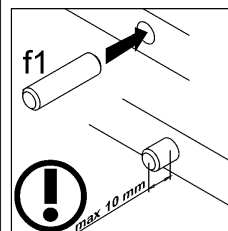
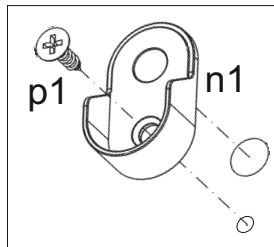
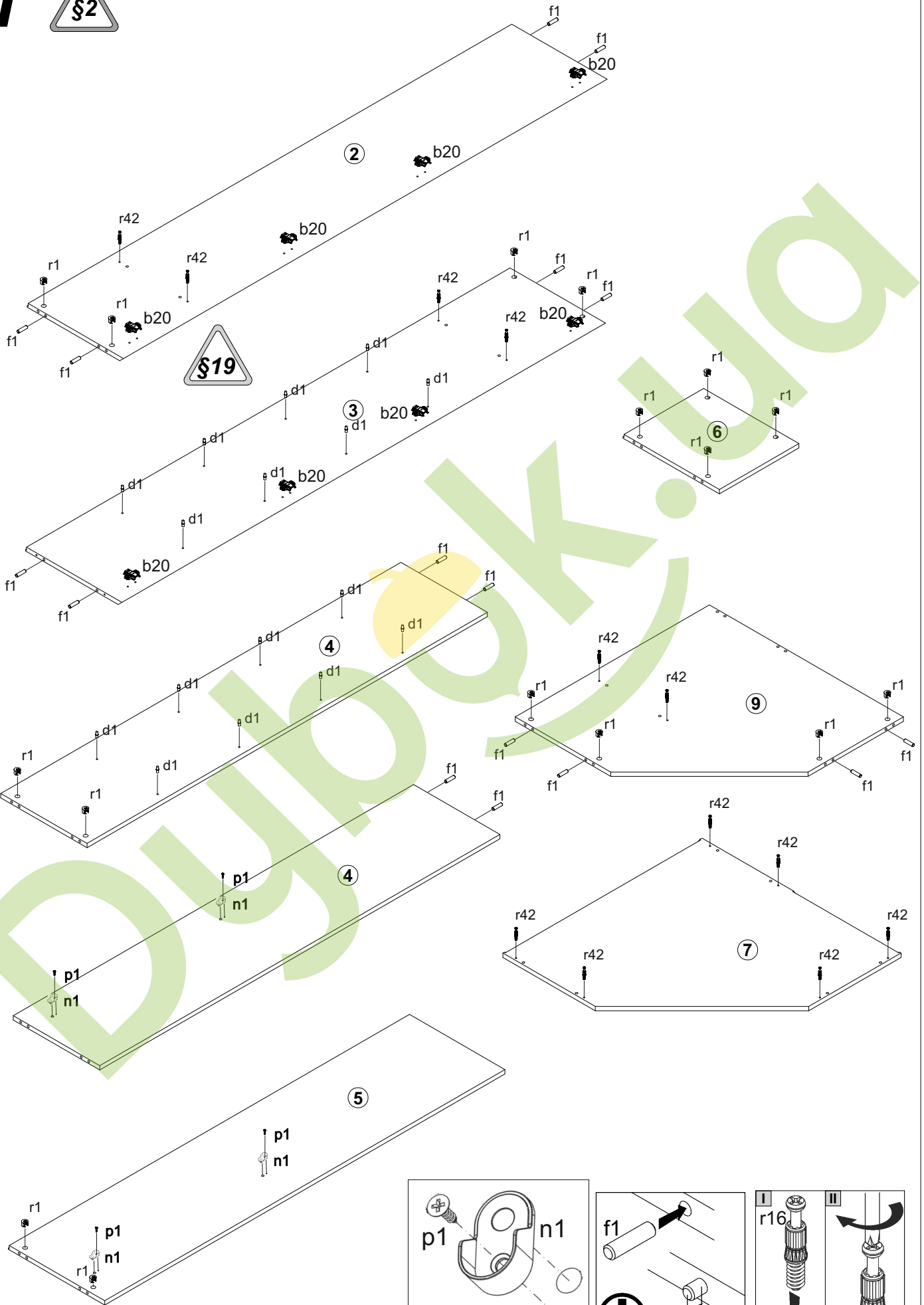

2

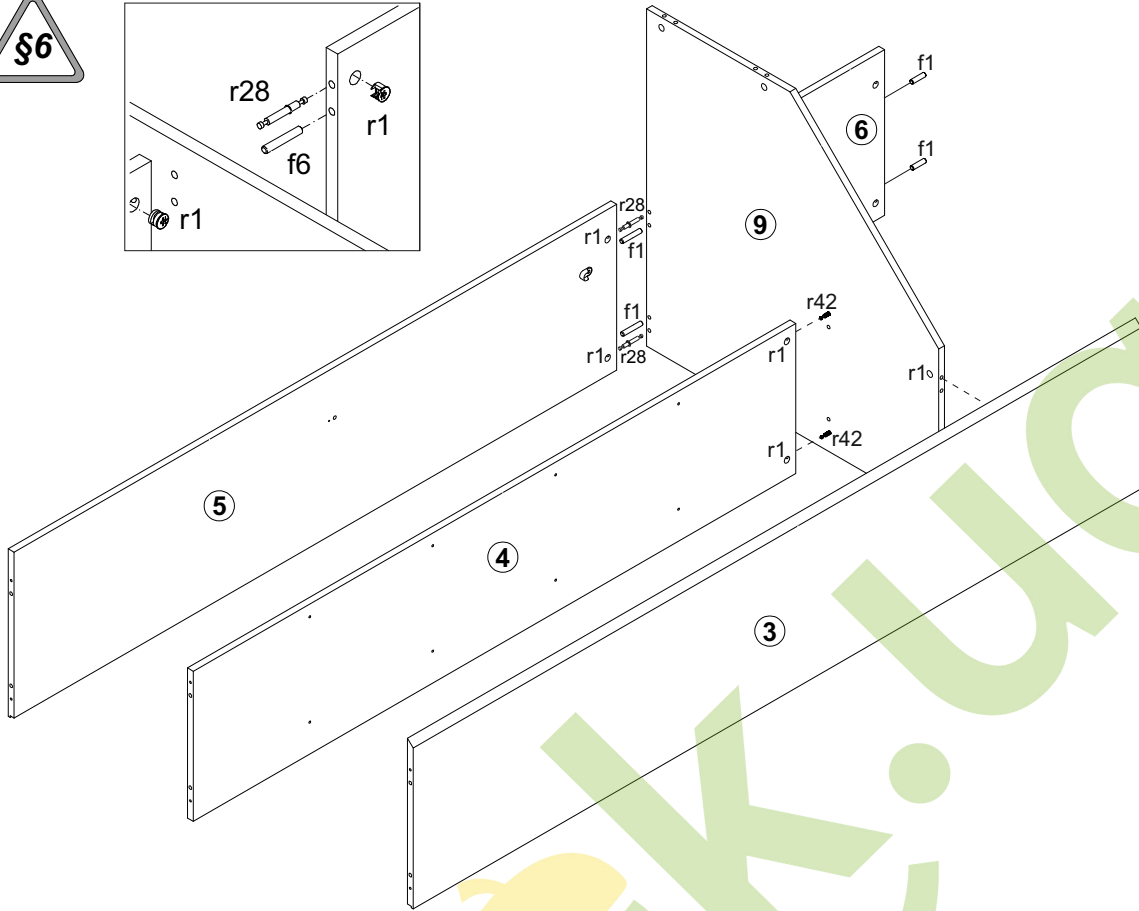
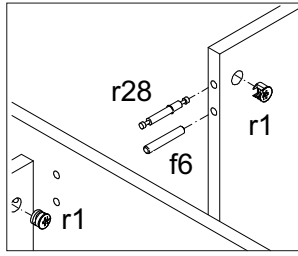

3

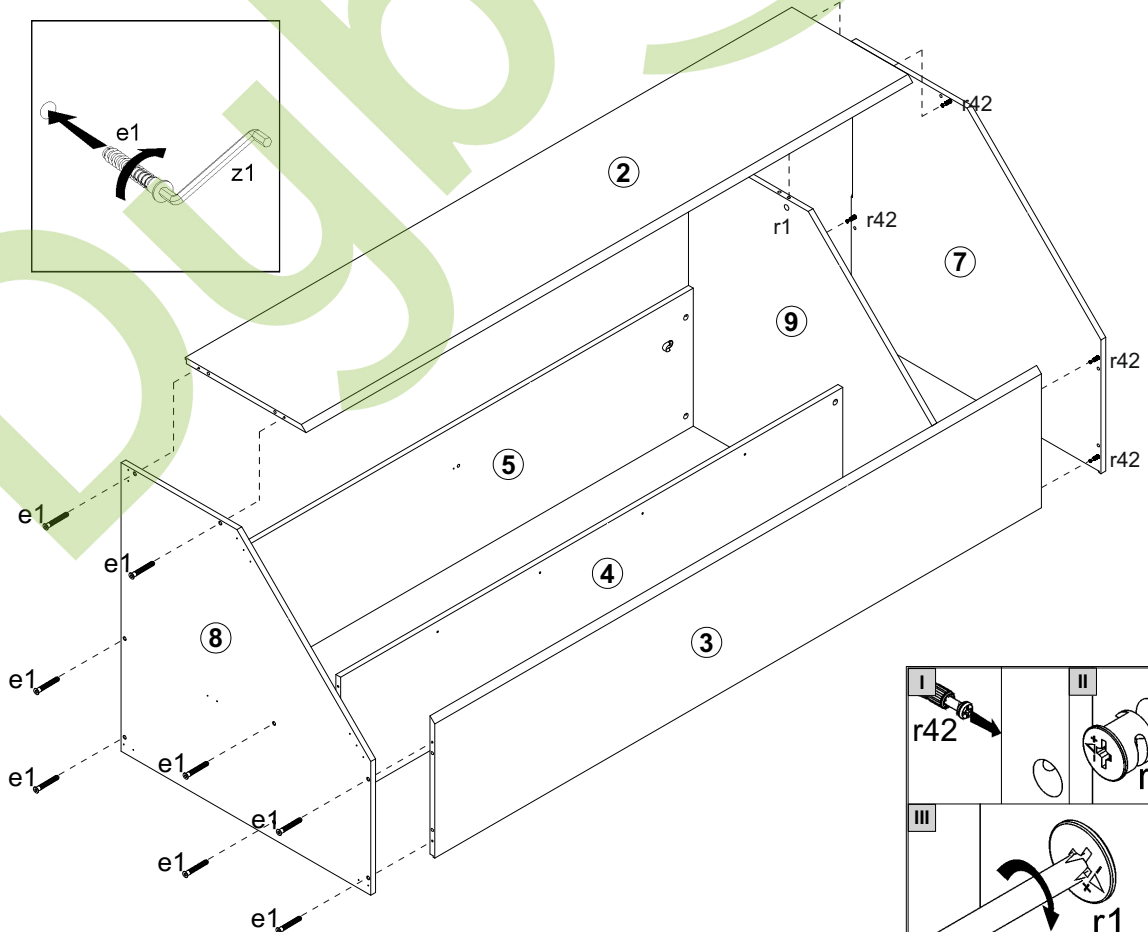
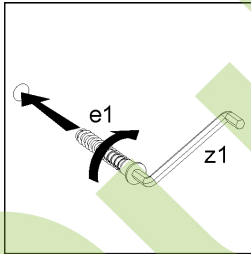

4

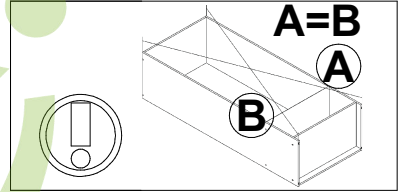
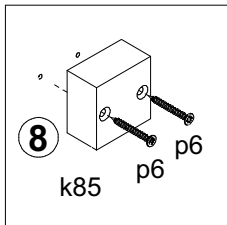
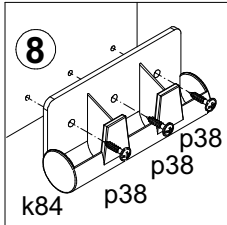
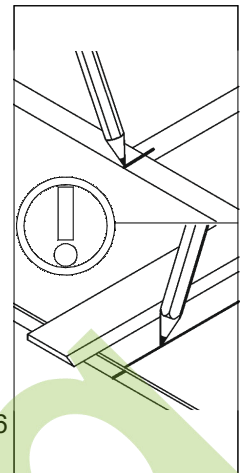
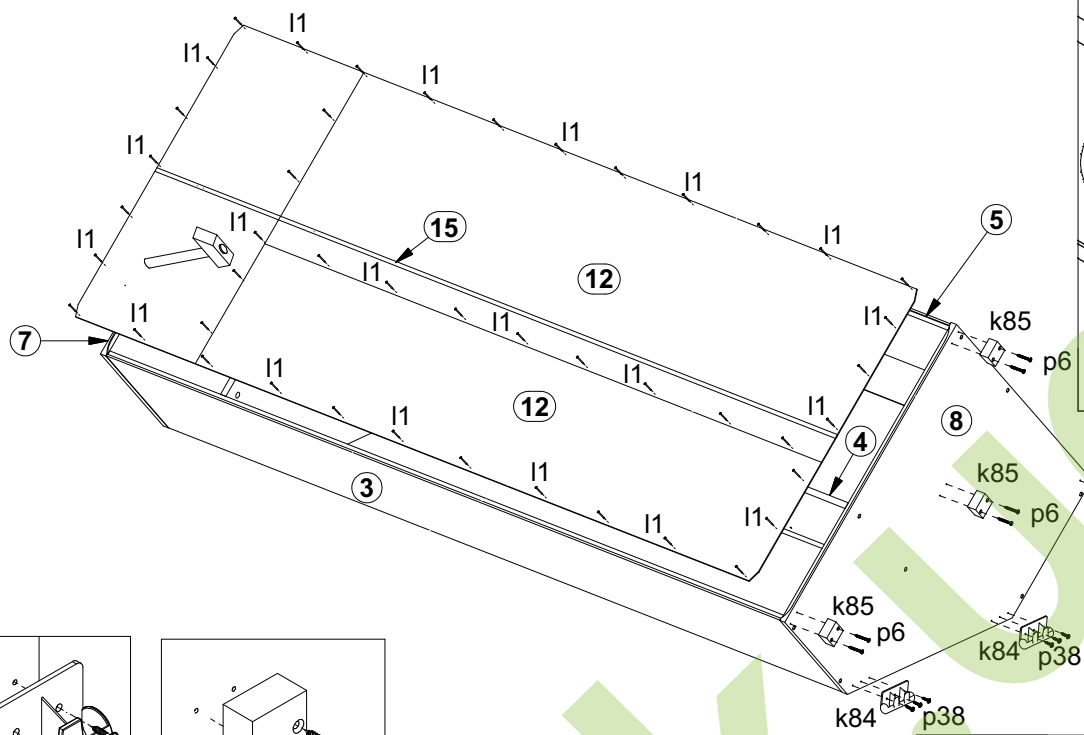

5

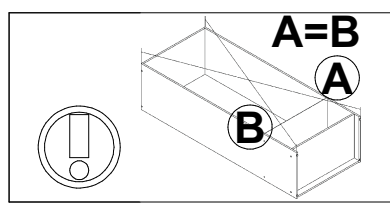
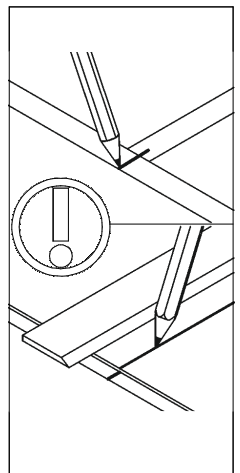
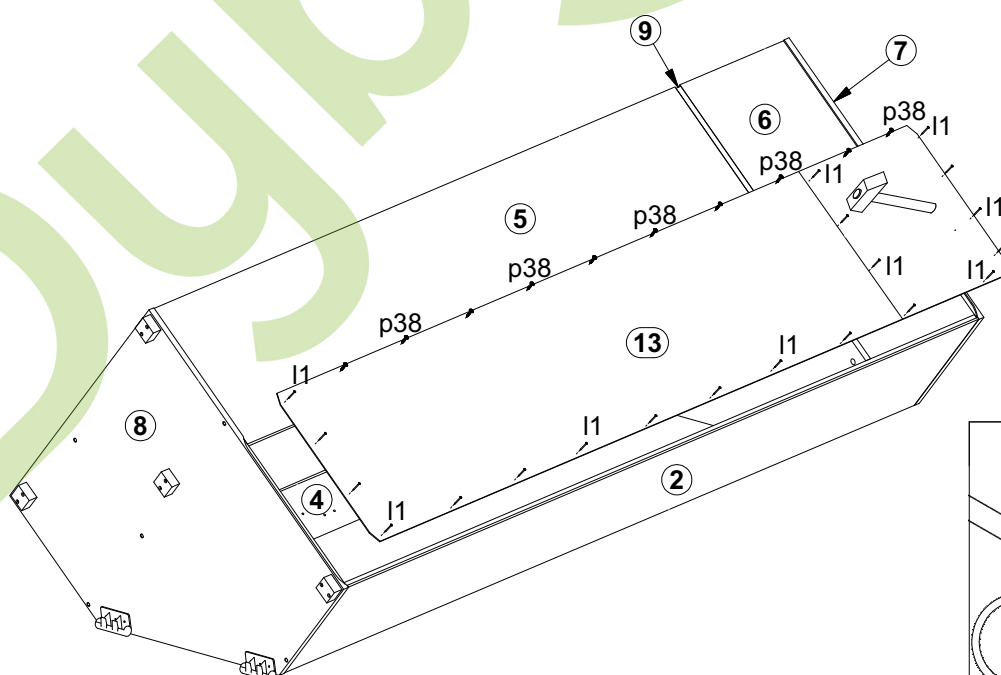

6

