

МОДЕН, МОДЕН-Р

Надставка NAD2D/120

A	B	C	D	
1	S321-113-01	1718	355	1/2
2	S321-114-01	1718	355	1/2
3	S321-117-01	788	354	1/2
4	S321-301	1166	354	1/2
5	S321-319	1166	354	1/2
6	S321-320	575	354	1/2
7	S321-321	575	345	1/2
8	S321-419	1166	68	1/2
9	S321-919	872	596	1/2
10	S321-918	809	596	1/2
11	LH-828	828		1/2
12	S321-008	596	530	2/2
13	S321-008-01	596	530	2/2



→ МОДЕН
→ МОДЕН-Р

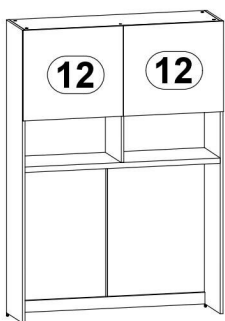
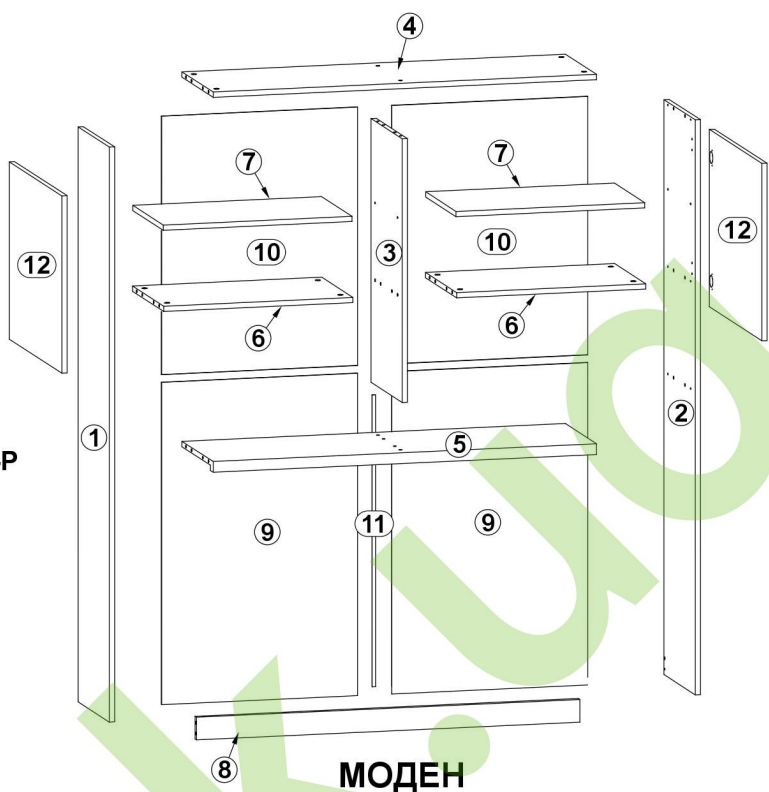

МОДЕН

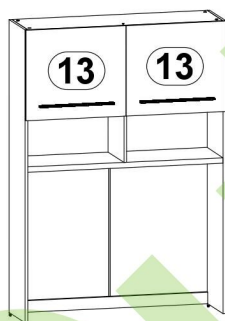
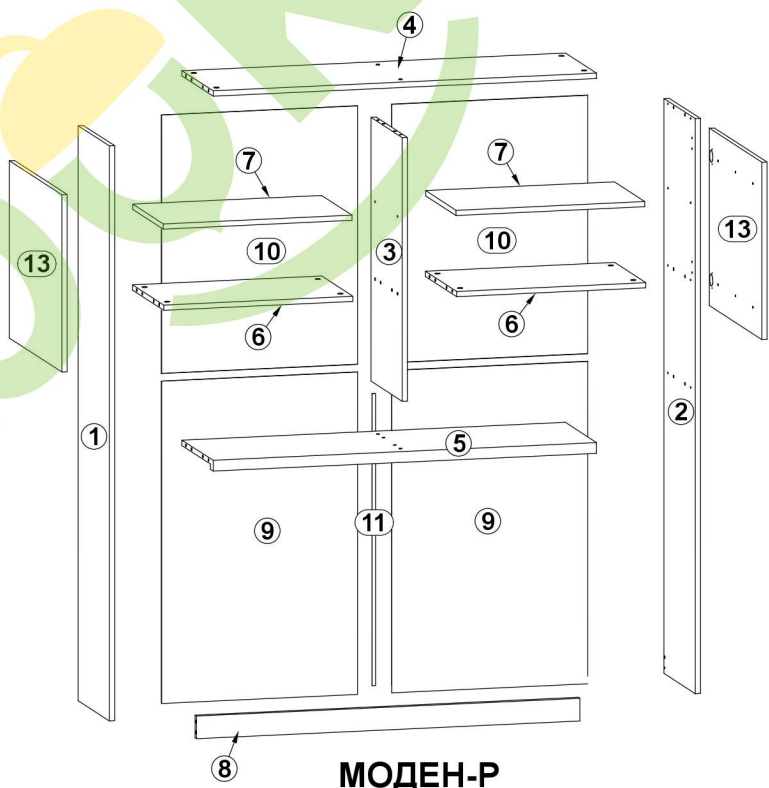

МОДЕН-Р

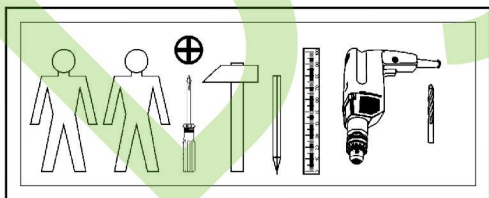

4x a44	4x b19	8x d1 Øx17 mm	4x e1 Øx50 mm	18x f1 Øx30 mm	2x f6 Øx50 mm	65x l1	1x n26v1
2x n52 62x12/1mm	4x o21 silikon	9x p38 Ø,5x16 mm	8x p51 Ø,5x15 mm	6x p79 Ø,5x20 mm	18x r1 Ø,5x12mm #16	2x r10	14x r16 20/9
2x s1	12x s2 Ø6	1x z1	6x p8 Øx25 mm		2x c253 ⁹ 445 mm		

МОДЕН-Р

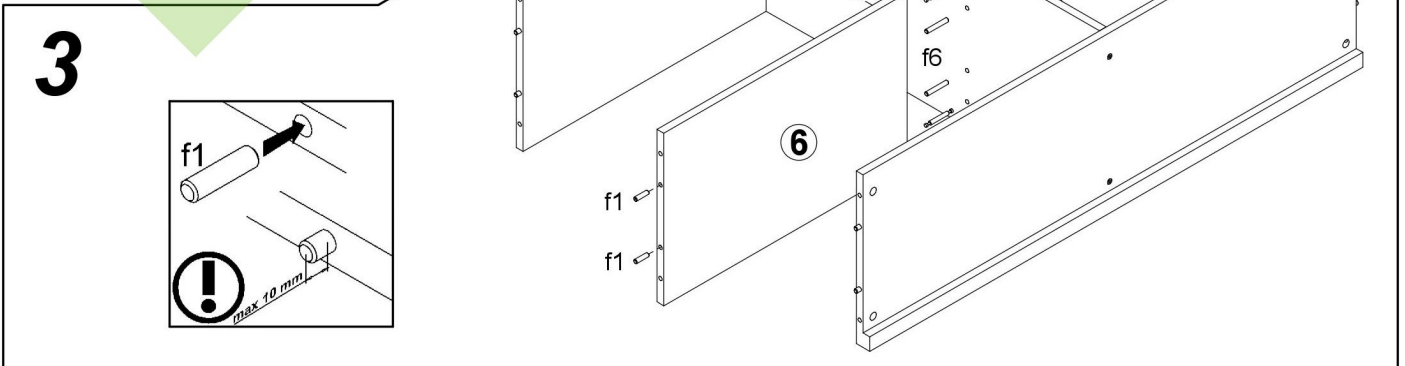
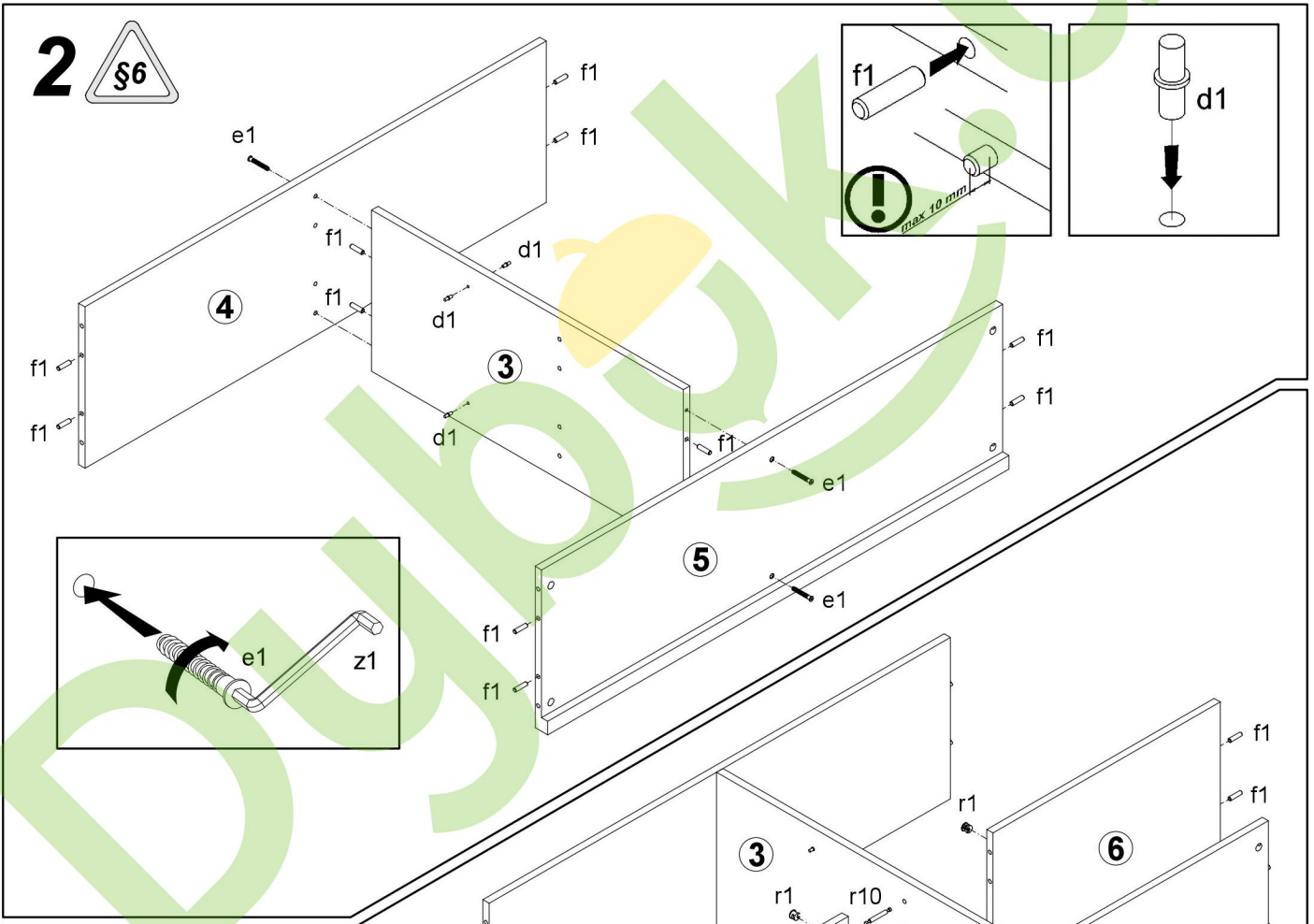
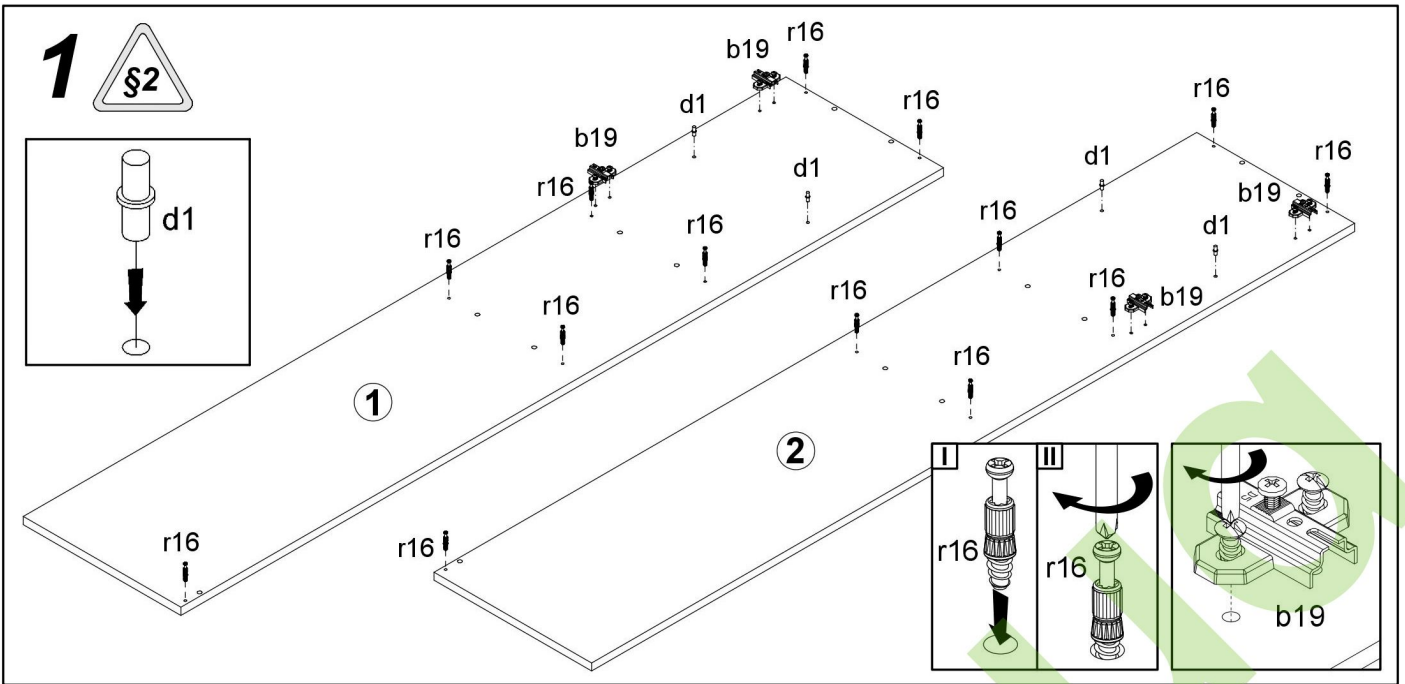

4

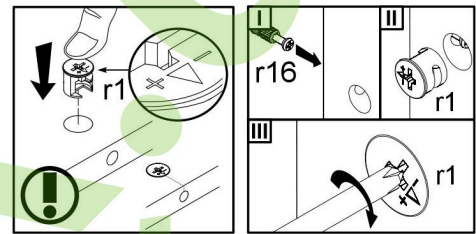
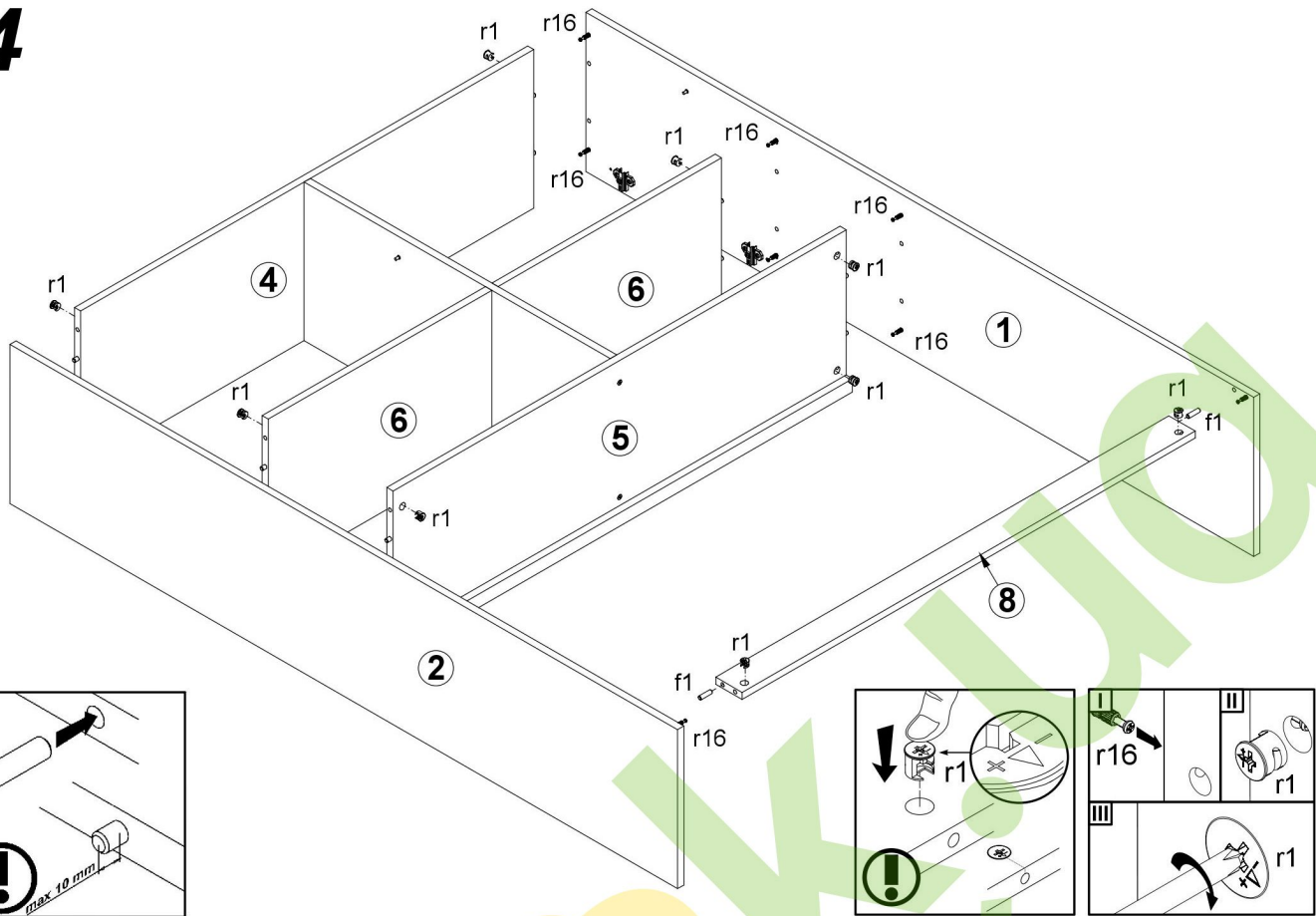

5

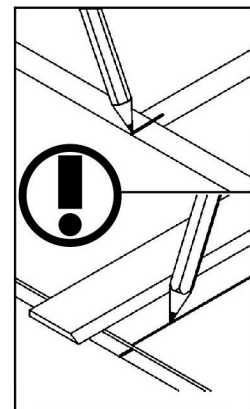
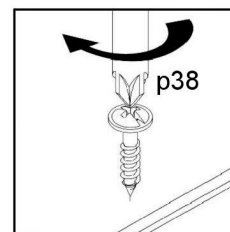
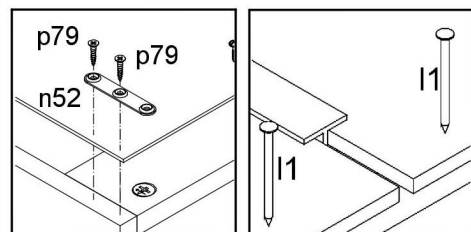
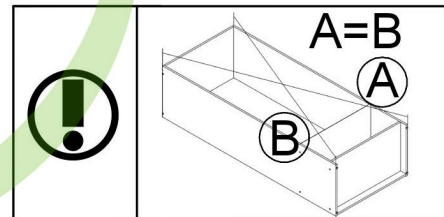
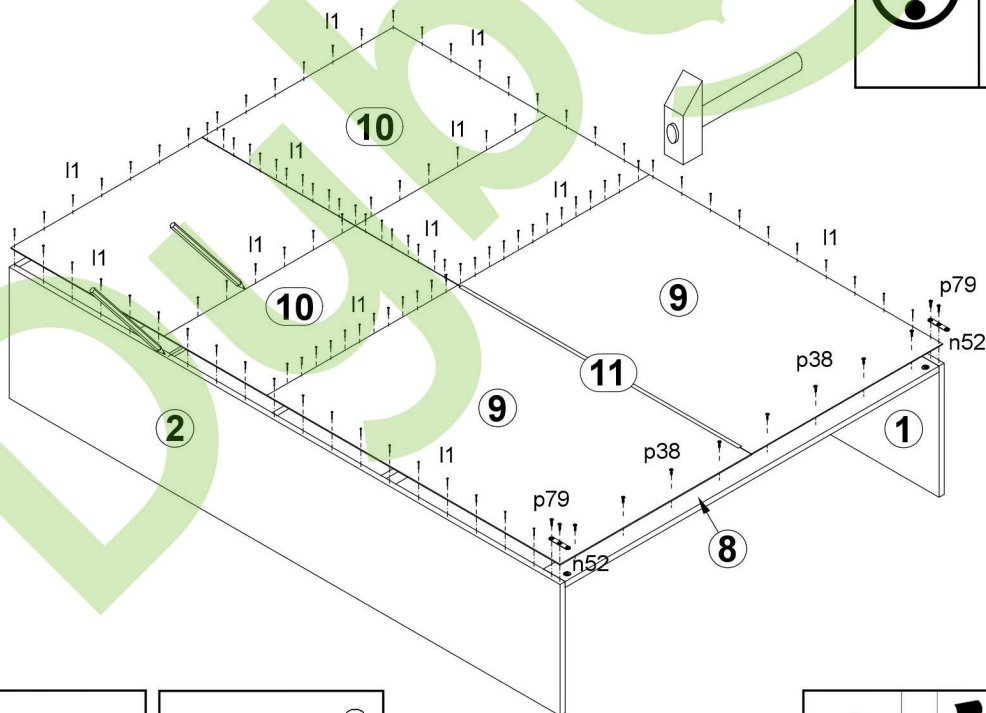

6



p38
n26\1

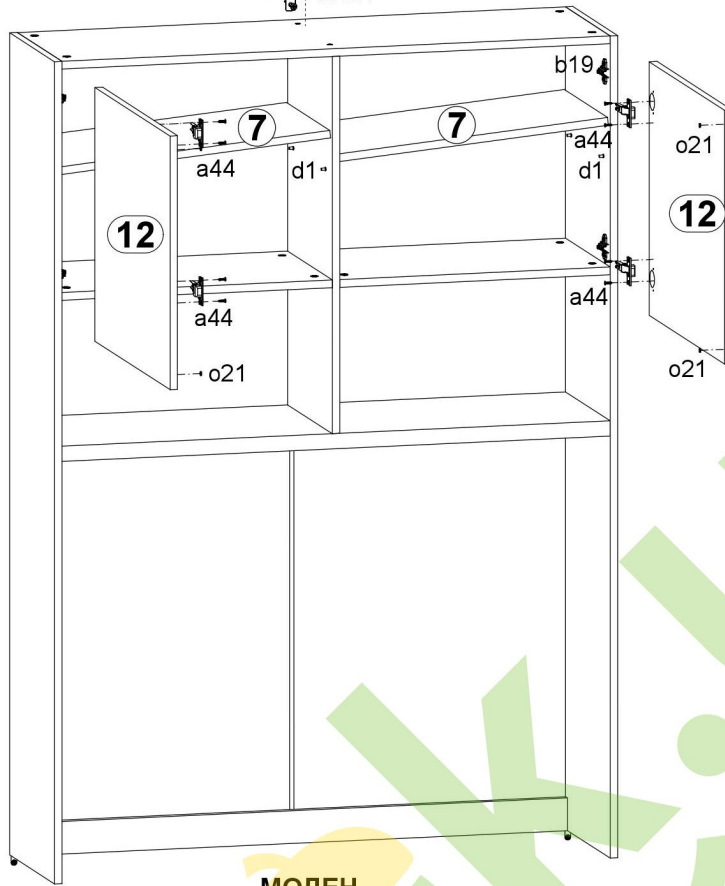
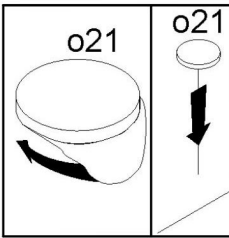
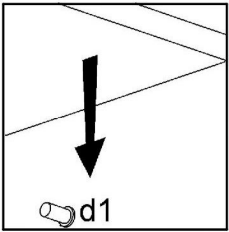
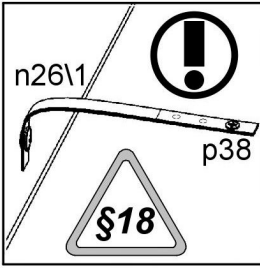
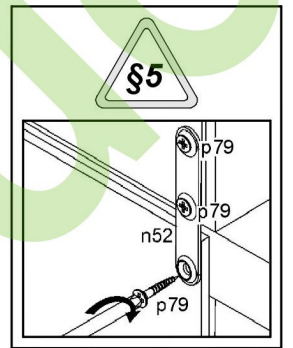
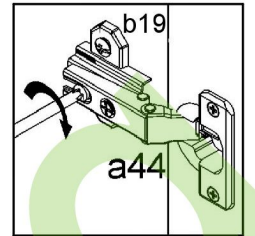
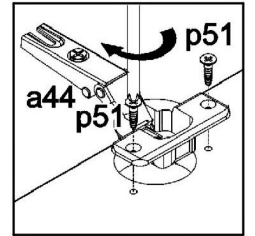

МОДЕН

p38
n26\1

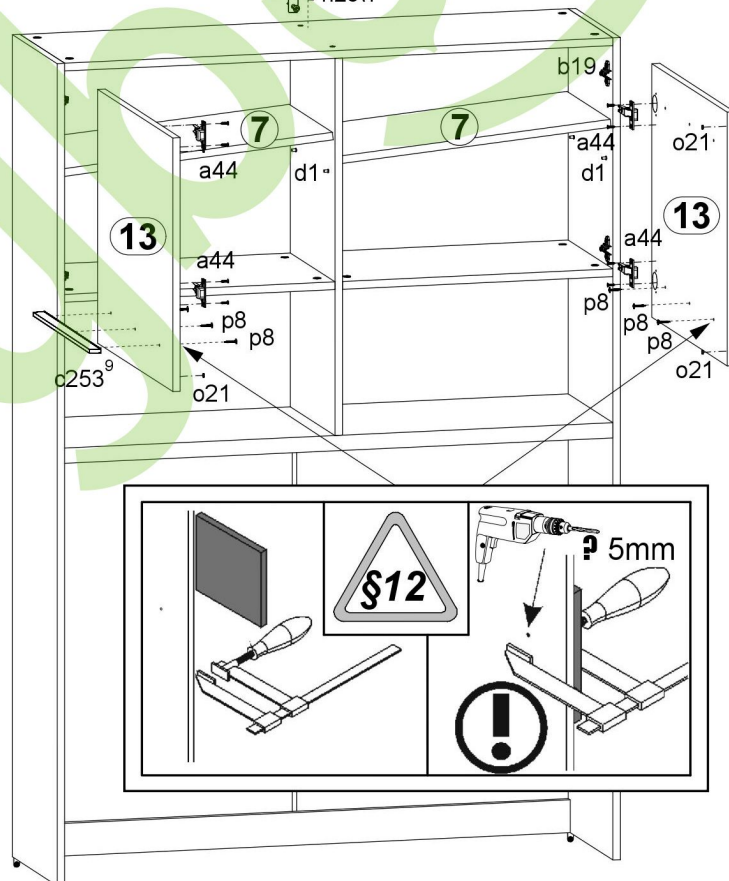
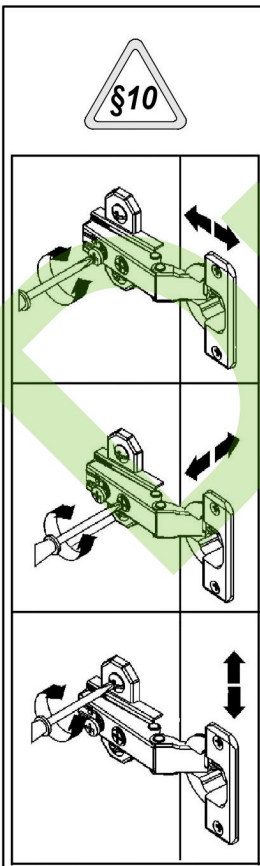

МОДЕН-P

