

МОДЕН, МОДЕН-Р

Комод КОМ2S/120

A	B	C	D
1	S321-101	566	505 1/2
2	S321-102	566	505 1/2
3	S321-133	490	493 1/2
4	S321-202	1199	506 1/2
5	S321-415	1166	60 1/2
6	S321-416	1166	60 1/2
7	S321-417	1166	68 1/2
8	S321-418	1166	68 1/2

A	B	C	D
9	S321-501	500	160 1/2
10	S321-502	500	160 1/2
11	S321-504	518	160 1/2
12	S321-909	533	499 1/2
13	S321-908	1193	517 1/2
14	S321-007	1195	250 2/2
15	S321-007-01	1195	250 2/2

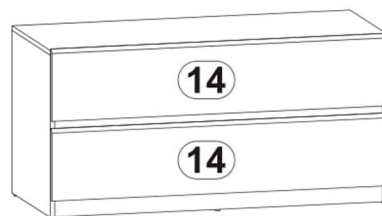

МОДЕН

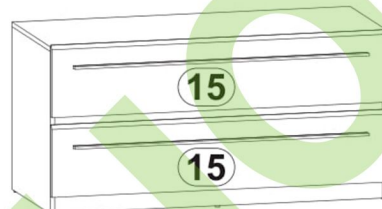

МОДЕН-Р

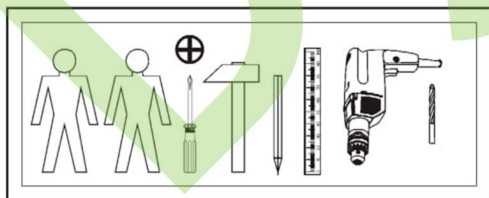
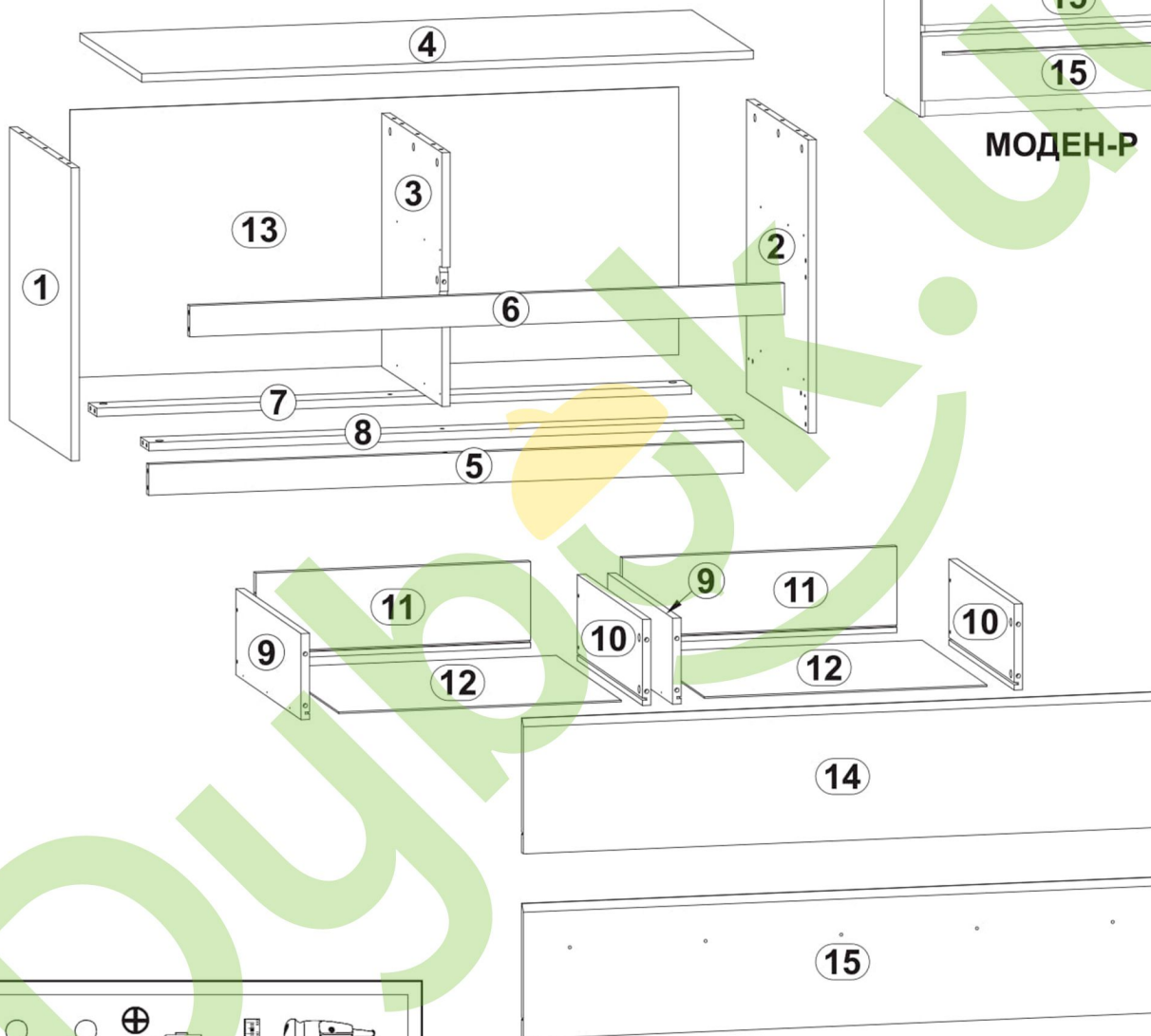

2x φ7x50 mm e1	18x φ6x13 mm e3	16x φ5x50 mm e32	19x φ8x30 mm f1	5x k1	40x l1	1x n26V1	8x silikon o21	
6x φ3,5x13 mm p1	1x φ3,5x16 mm p38	24x φ3x12 mm p54	30x φ15x12mm #16 r1	30x 20/9 r16	19x φ16 s2	4x 500 mm w26^{CL}	4x 500 mm w26^{CR}	
4x 500 mm w26^{DL}	4x 500 mm w26^{DR}	1x z1	10x φ4x25 mm p8					2x 1045 mm c253¹¹
							МОДЕН-Р	

1

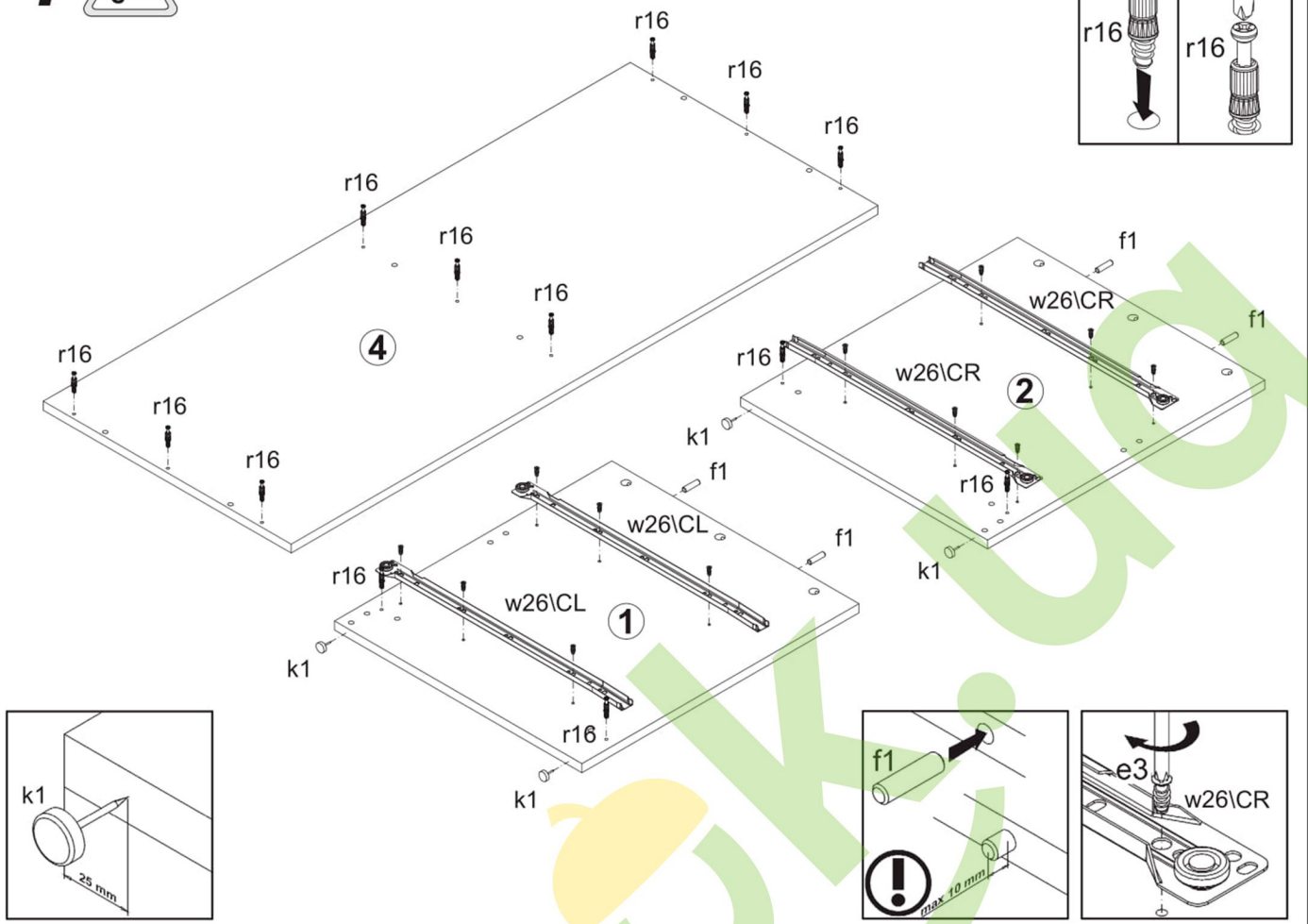
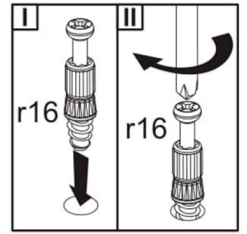

2

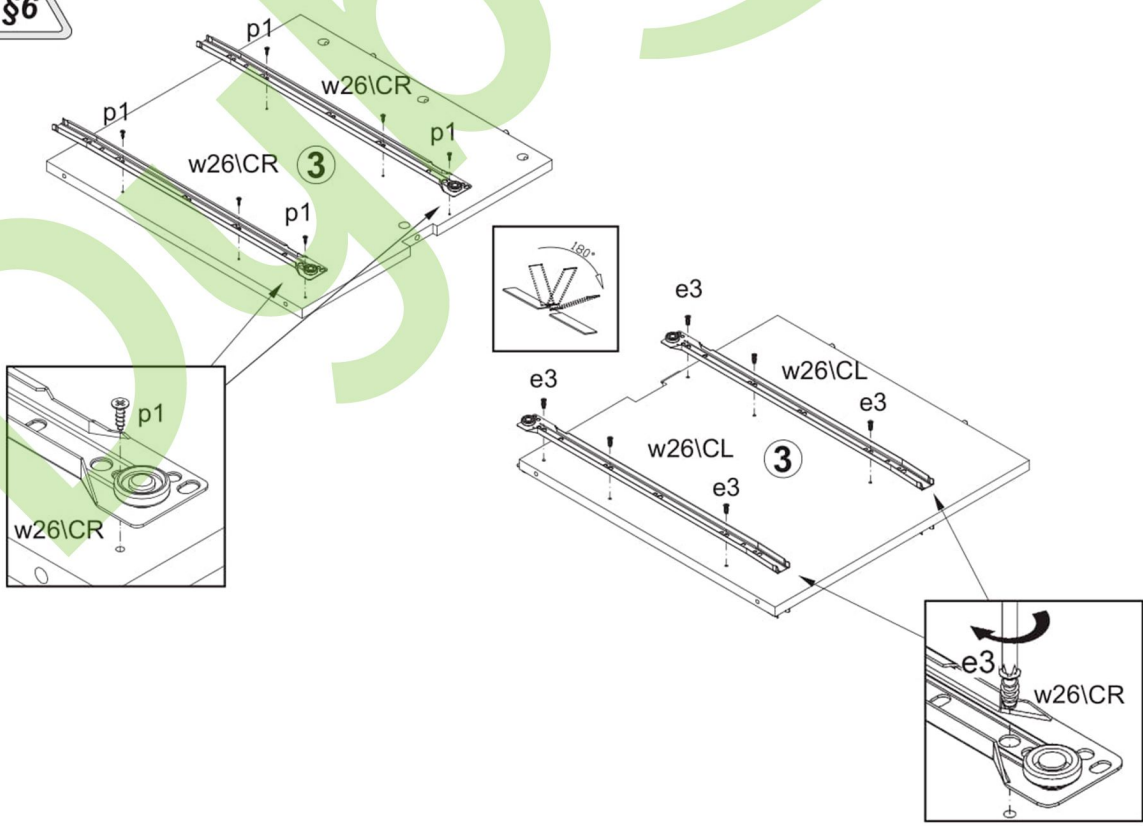

3

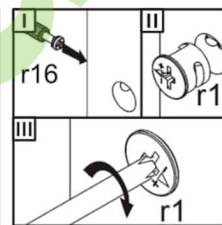
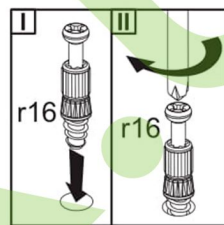
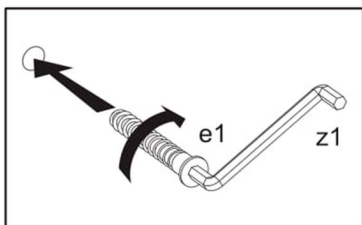
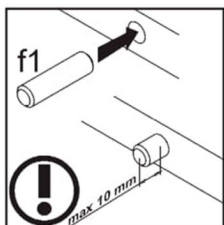
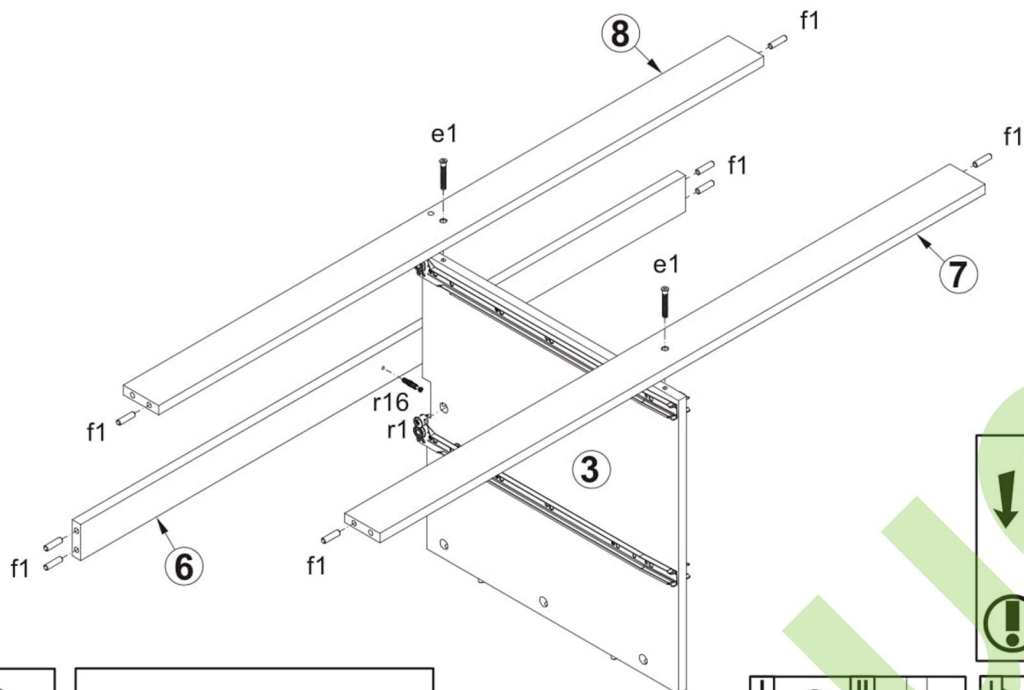

4

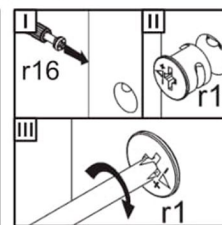
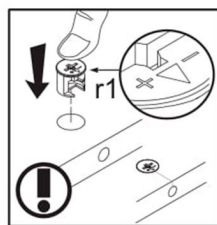
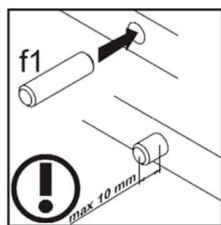
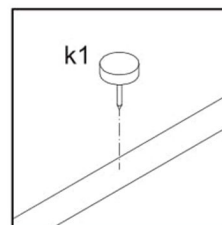
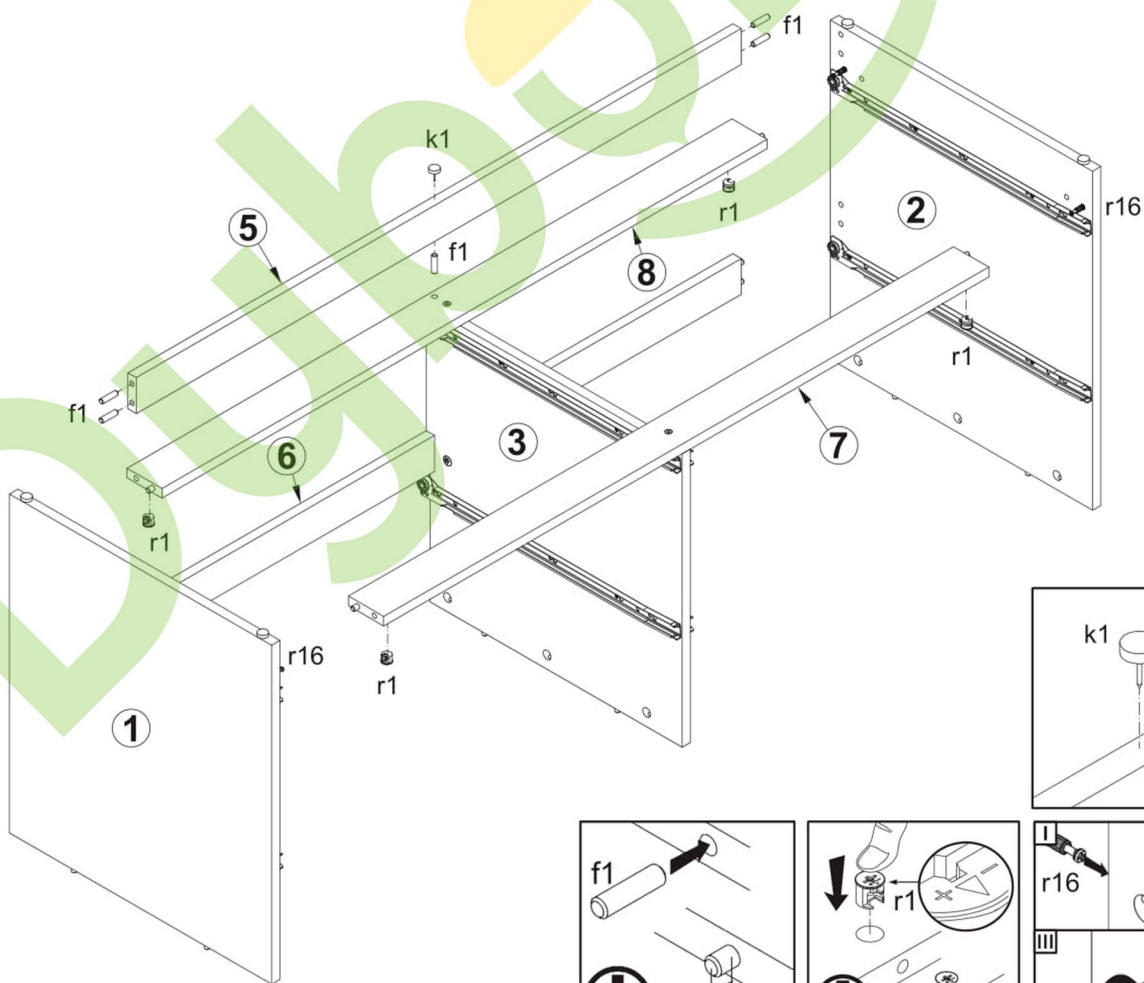

5

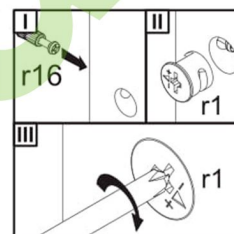
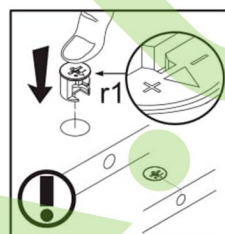
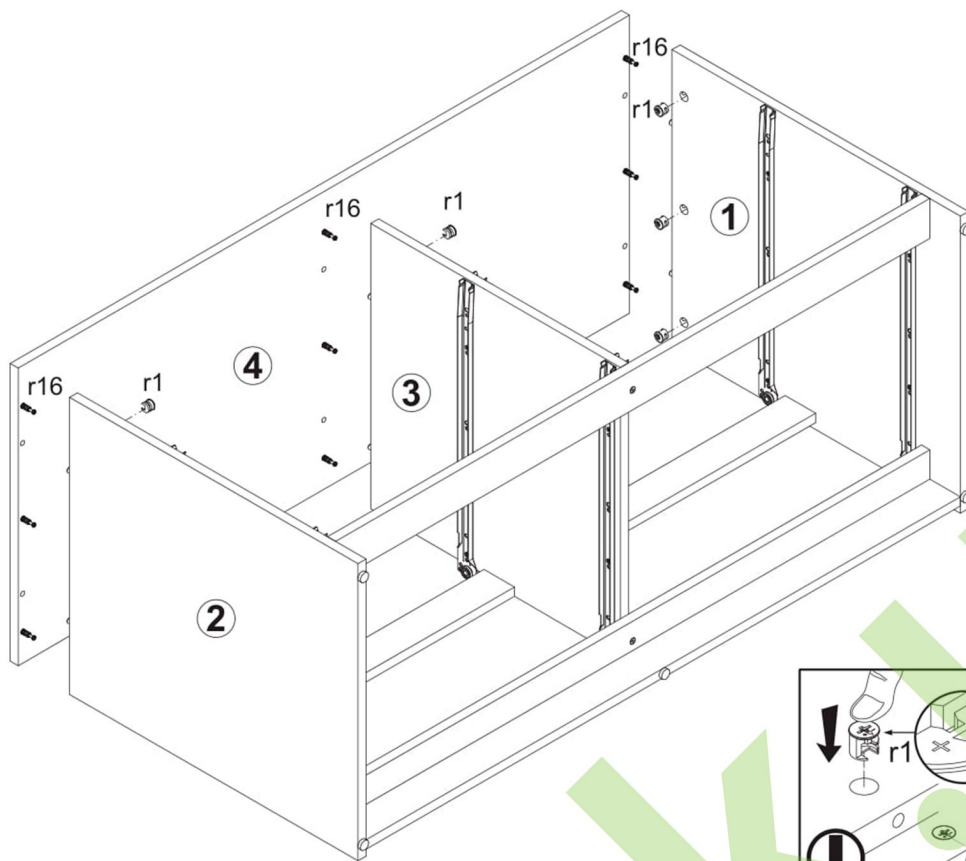

6

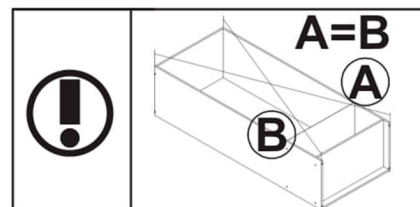
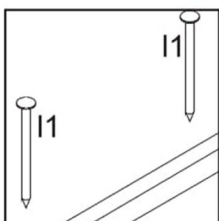
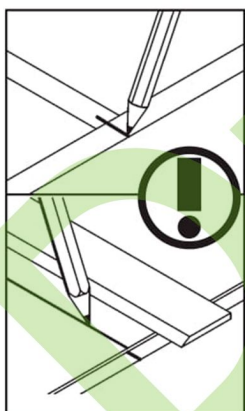
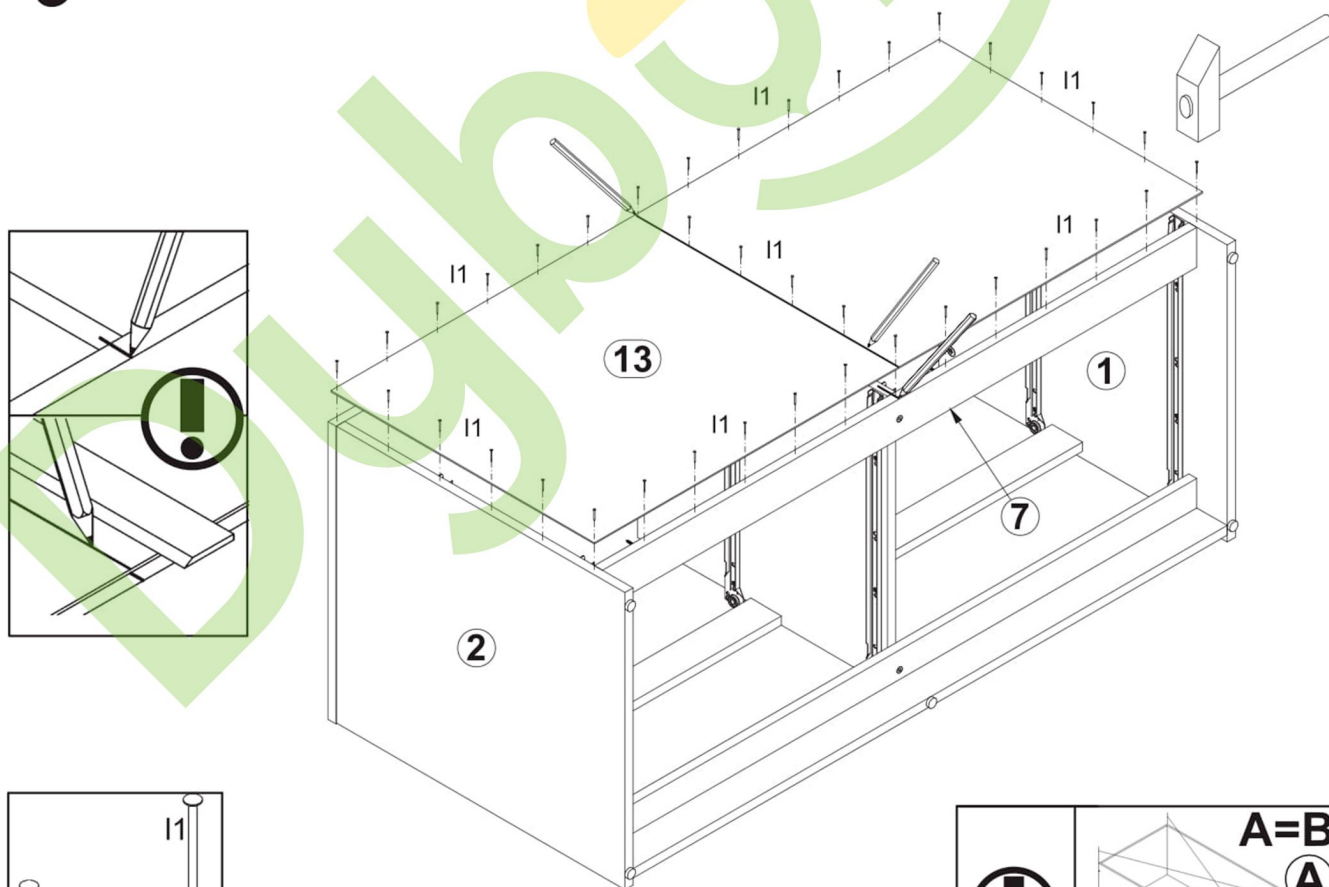

7 МОДЕН

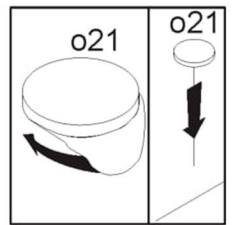
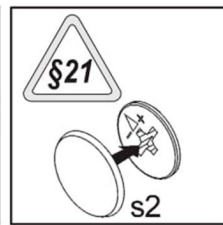
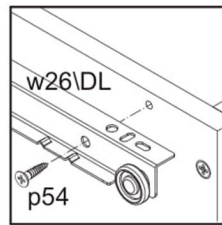
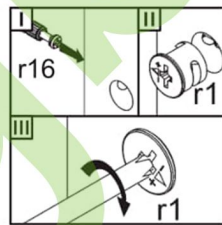
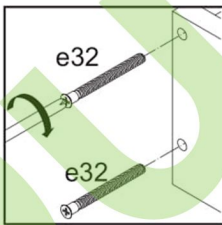
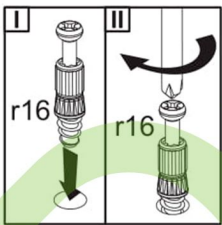
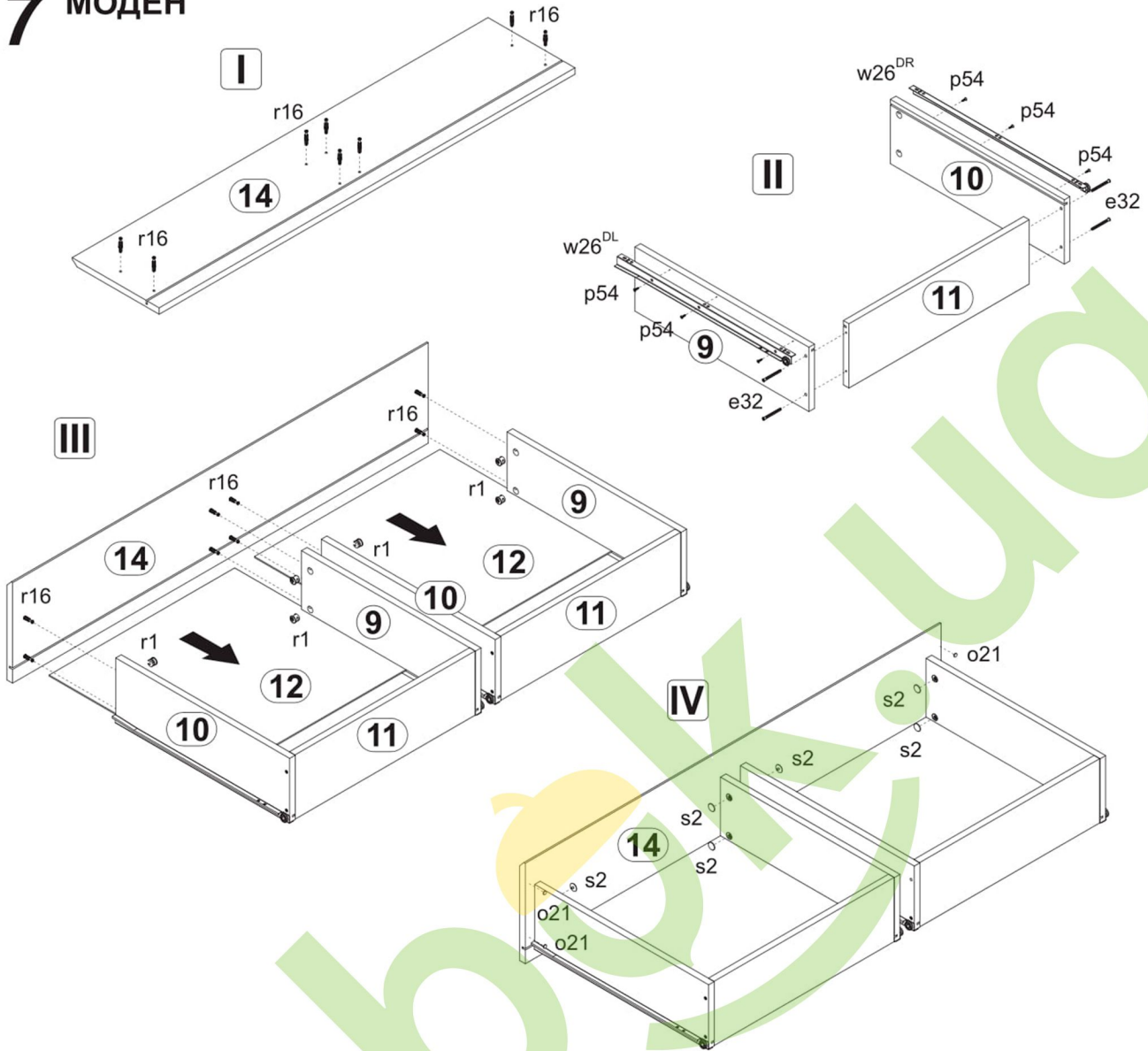

8 МОДЕН

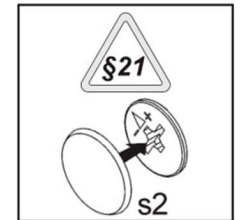
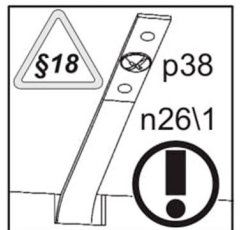
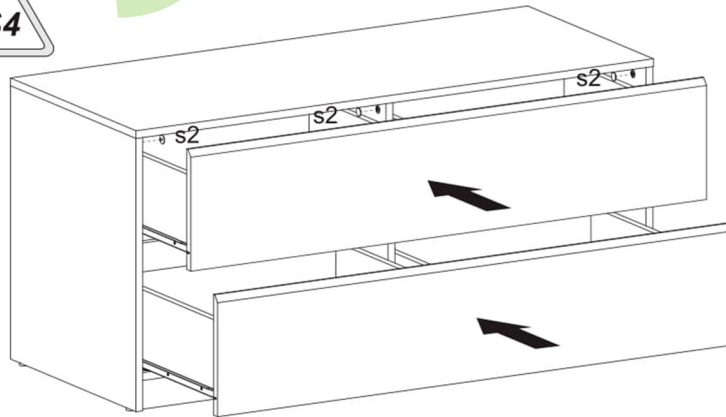
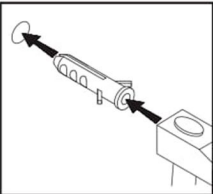
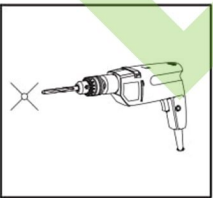

7 МОДЕН-Р

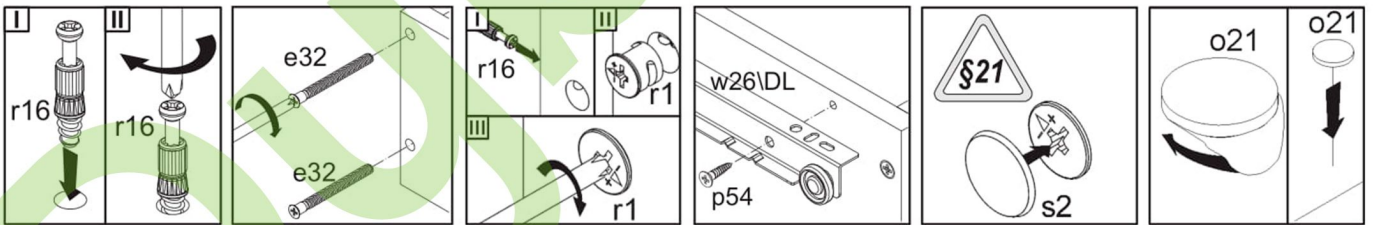
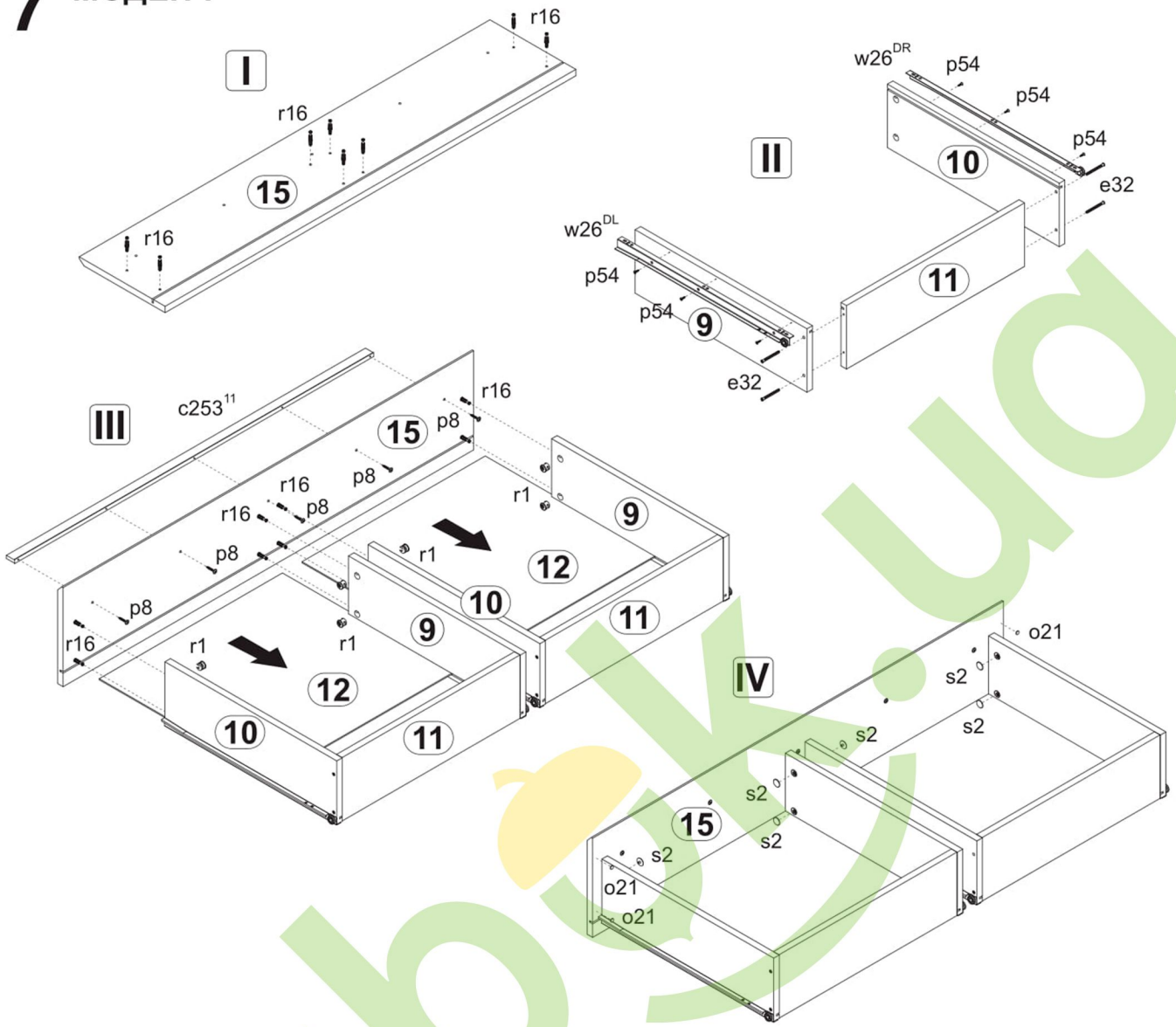

8 МОДЕН-Р

