

# МОДЕН, МОДЕН-Р

Вітрина / Витрина **REG1W2S/60/L/P**

A	B	C	D	
1	S321-109-01	2300	355	1/4
2	S321-110-01	2300	355	1/4
3	S321-906	2235	296	1/4
4	LH-2207	2207		1/4
5	S321-309	567	354	2/4
6	S321-310	567	345	2/4
7	S321-407	567	60	2/4
8	S321-431	567	60	2/4
9	S321-413	567	68	2/4
10	S321-430	567	68	2/4
11	S321-505	350	160	2/4
12	S321-506	350	160	2/4
13	S321-507	510	160	2/4
14	S321-920	525	349	2/4
15	S321-511	960	563	3/4
17L	S321-704	596	530	4/4
17P	S321-706	596	530	4/4

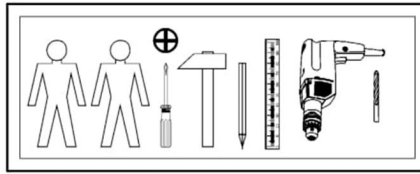

→ **МОДЕН; МОДЕН-Р** REG1W2S/60/L  
 → **МОДЕН; МОДЕН-Р** REG1W2S/60/P

## МОДЕН

16	S321-006	596	250	4/4	→ <b>МОДЕН</b> REG1W2S/60/L/P
18L	S321-705	596	250	4/4	→ <b>МОДЕН</b> REG1W2S/60/L
18P	S321-707	596	250	4/4	→ <b>МОДЕН</b> REG1W2S/60/P

## МОДЕН-Р

19	S321-006-01	596	250	4/4	→ <b>МОДЕН-Р</b> REG1W2S/60/L/P
20L	S321-705-01	596	250	4/4	→ <b>МОДЕН-Р</b> REG1W2S/60/L
20P	S321-707-01	596	250	4/4	→ <b>МОДЕН-Р</b> REG1W2S/60/P

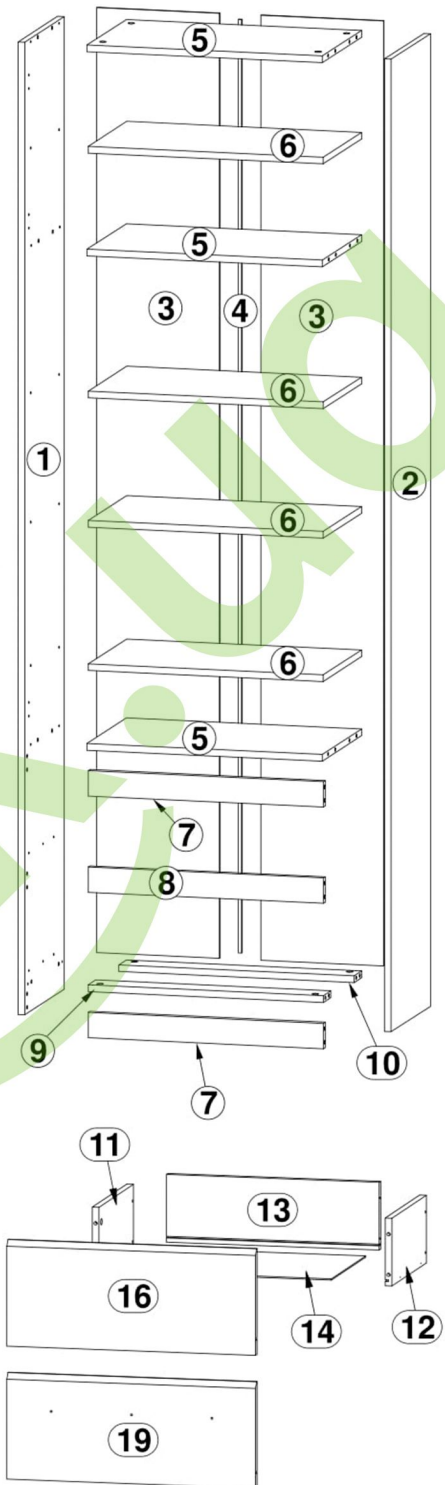

**МОДЕН**  
REG1W2S/60/L



**МОДЕН**  
REG1W2S/60/P



**МОДЕН-Р**  
REG1W2S/60/L



**МОДЕН-Р**  
REG1W2S/60/P

3x  a44	3x  b19	16x  d1 φ5x17 mm	12x  e3 φ6x13 mm	8x  e32 φ5x50 mm	8x  e41 φ5x12mm	28x  f1 φ8x30 mm	4x  k1
75x  l1	1x  n26\1	6x  o21 silikon	8x  o54 φ5.3\φ8.3x4.8 mm	1x  p38 φ3.5x16 mm	6x  p51 φ3.5x15 mm	8x  p54 φ3x12 mm	24x  r1 φ15x12mm #16
24x  r16 20/9	12x  s2 φ16	6x  s4	2x  w45\CL 350 mm	2x  w45\CR 350 mm	2x  w45\DL 350 mm	2x  w45\DR 350 mm	
						9x  p8 φ4x25 mm	3x  c253 <sup>9</sup> 445 mm

**МОДЕН-Р**

# 1

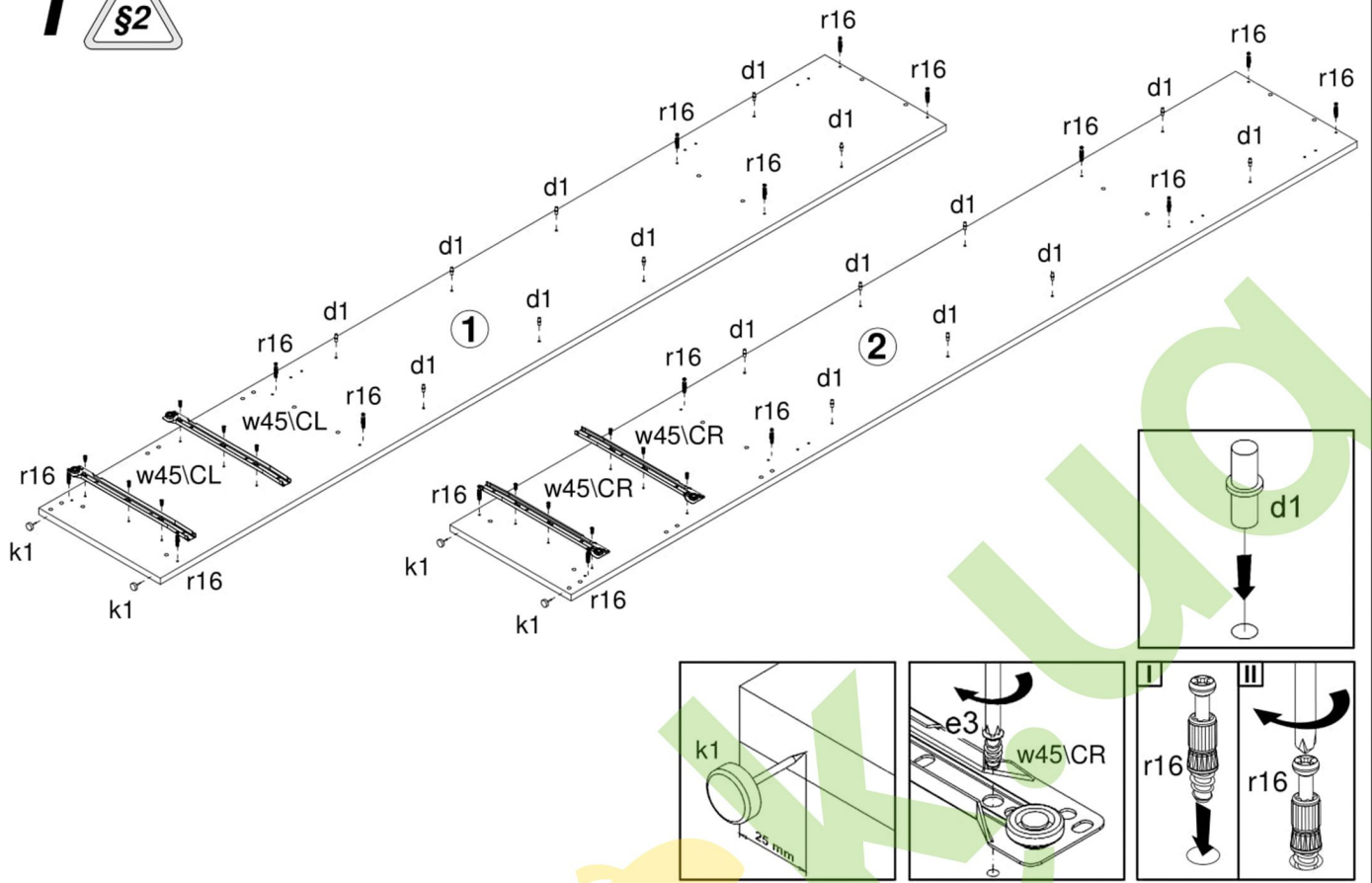

# 2

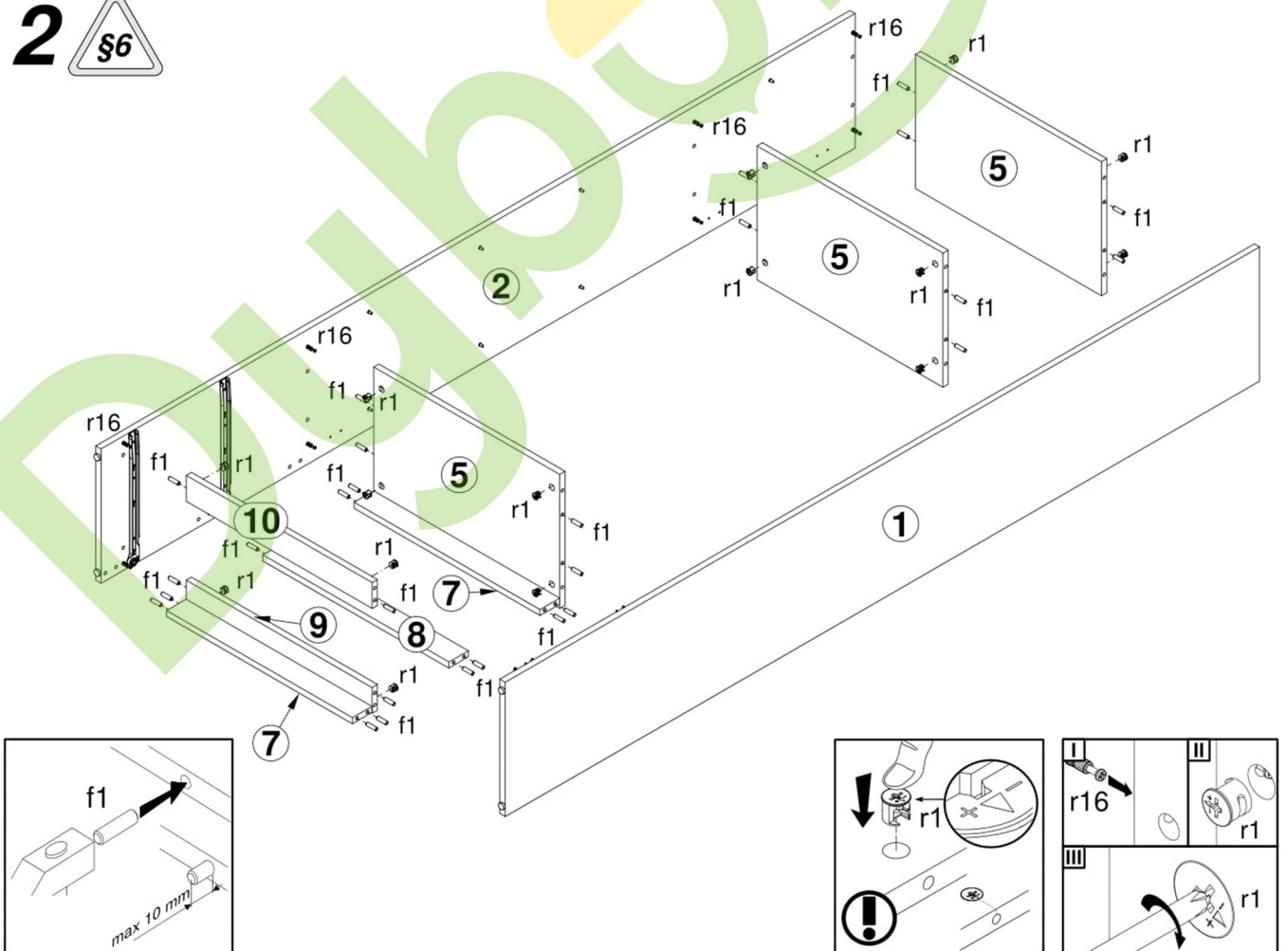

# 3

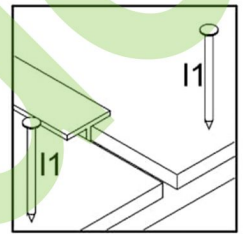
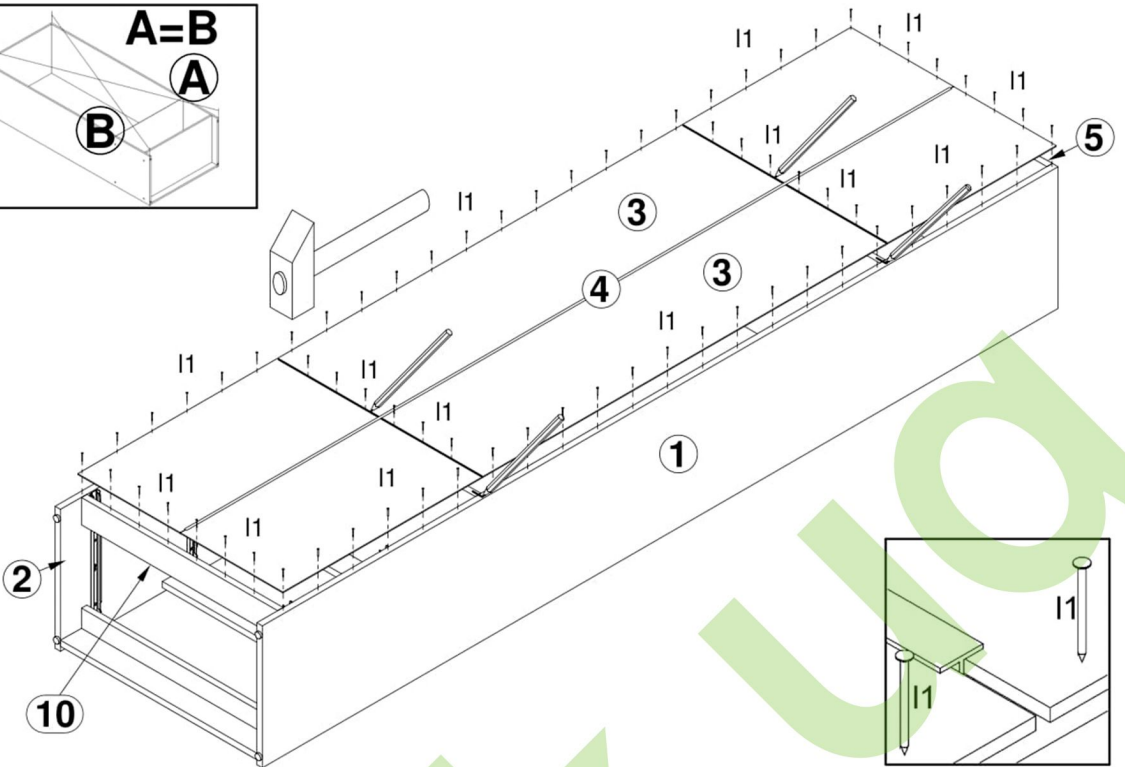
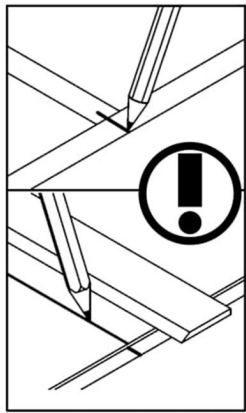
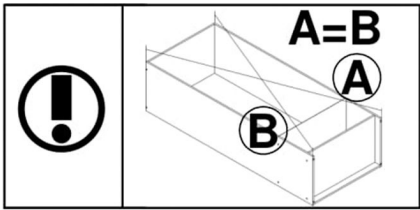

# 4 МОДЕН

## I

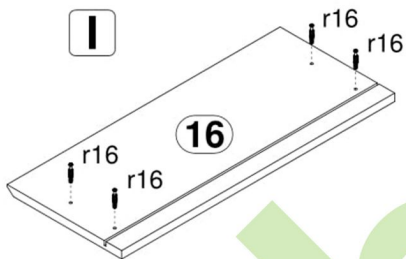

## II

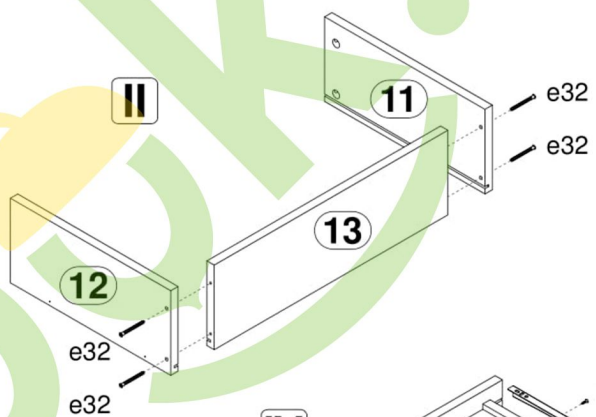

## III

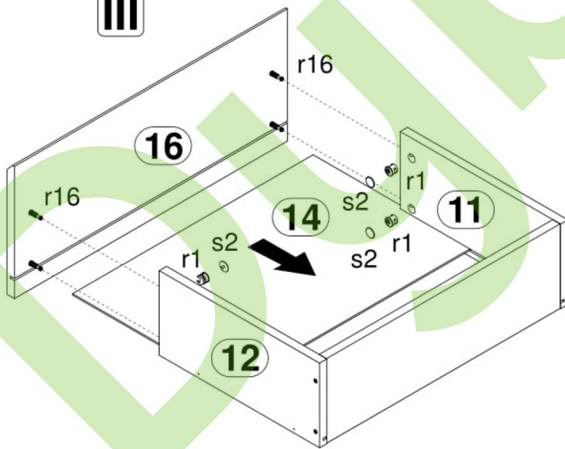

## IV

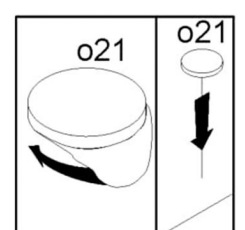
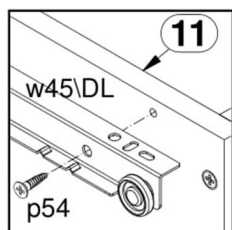
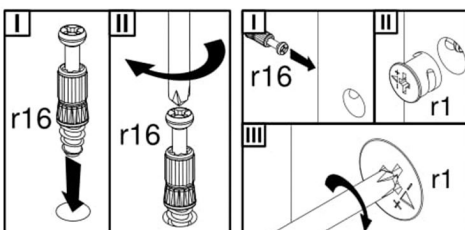
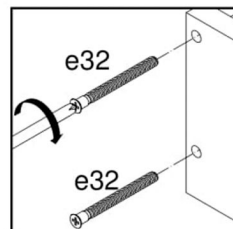
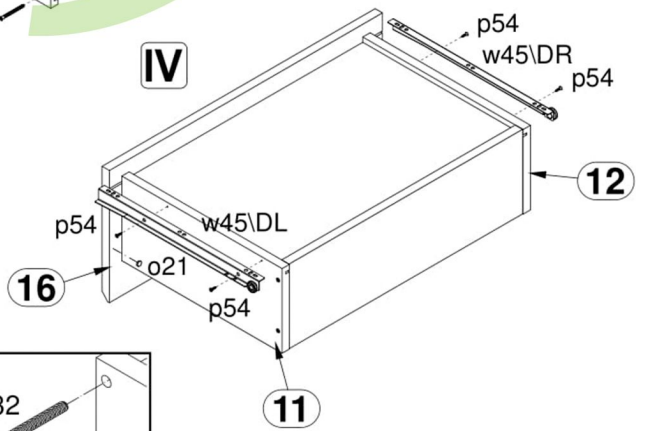

# 5 МОДЕН REG1W2S/60/L

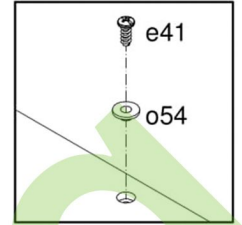
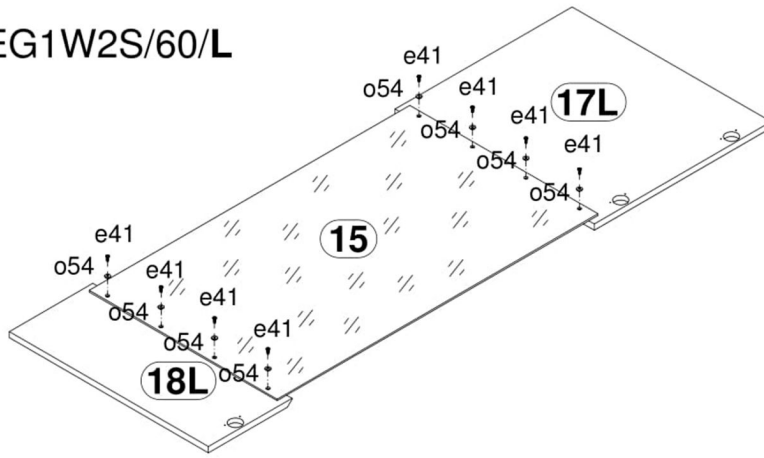

# 6 МОДЕН REG1W2S/60/L

p38  
n26\1

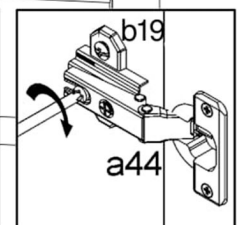
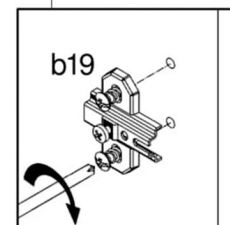
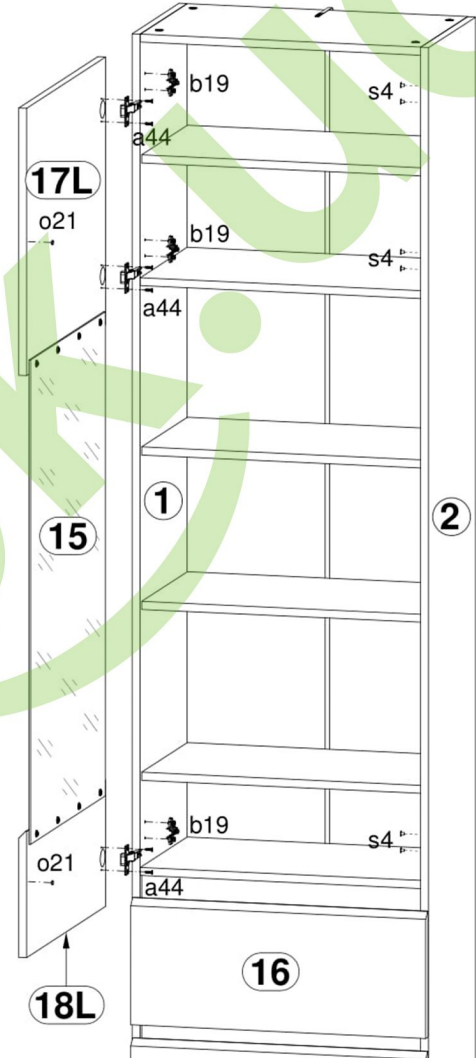
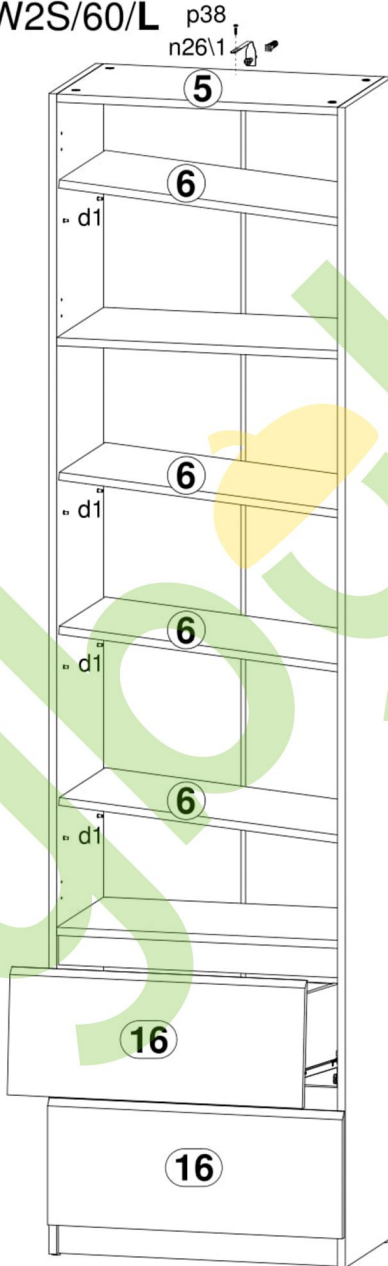
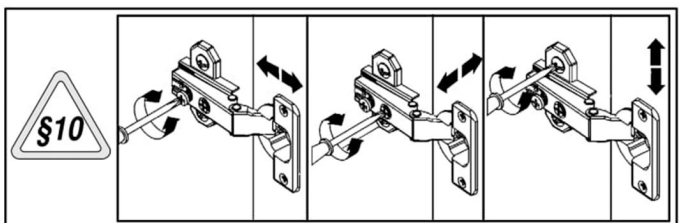
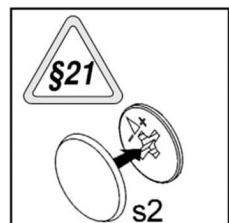
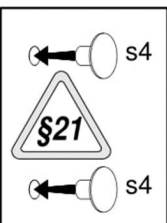
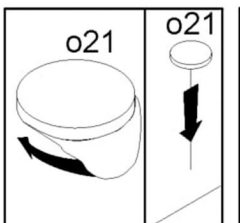
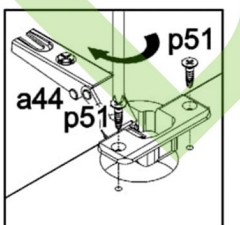
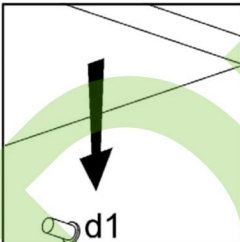
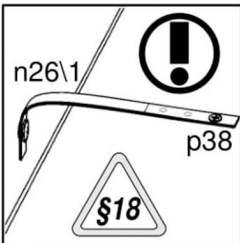
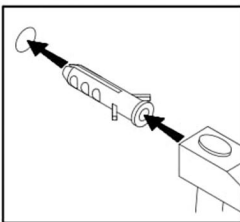
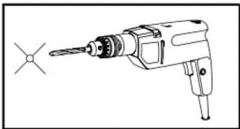

# 5 МОДЕН REG1W2S/60/P

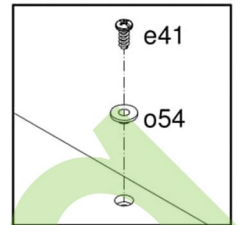
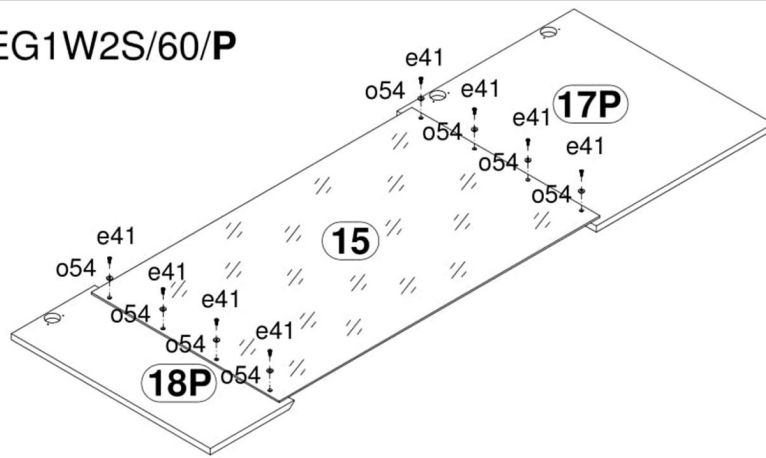

# 6 МОДЕН REG1W2S/60/P

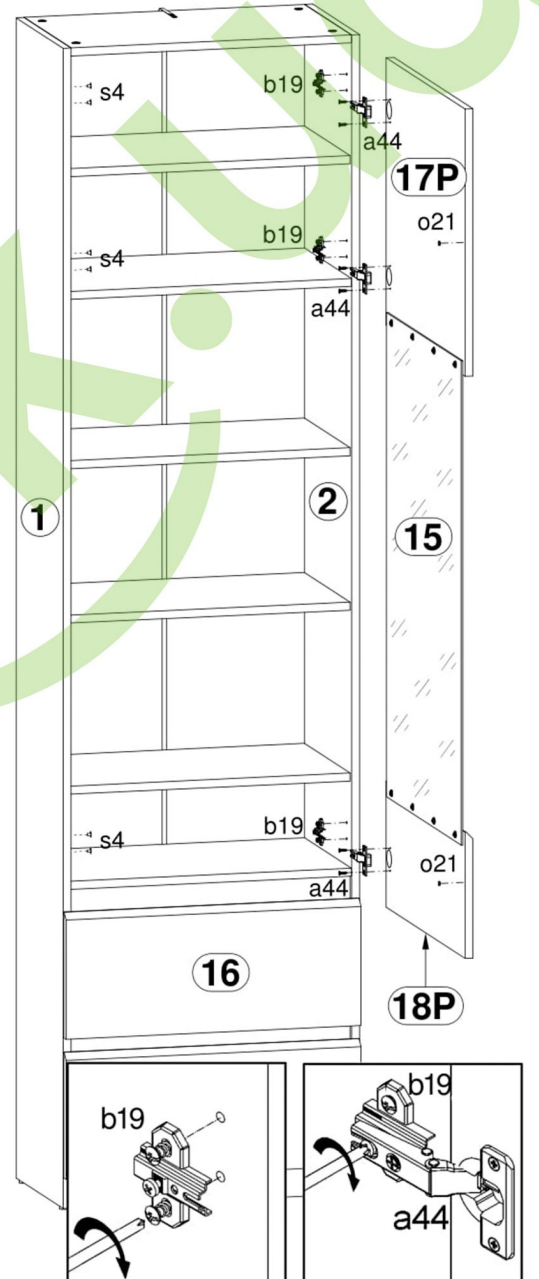
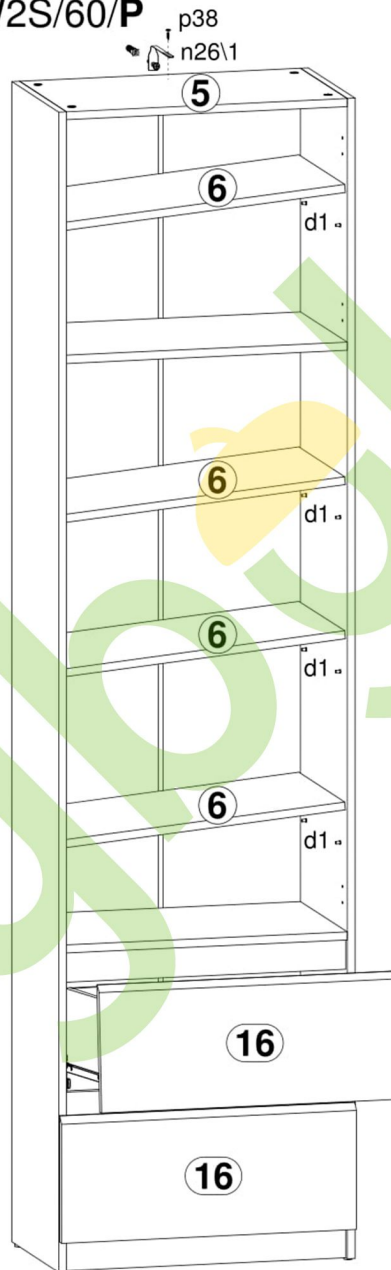
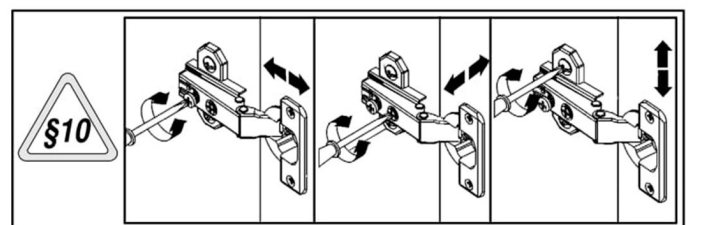
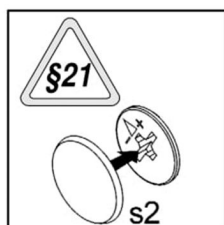
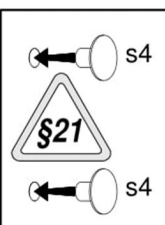
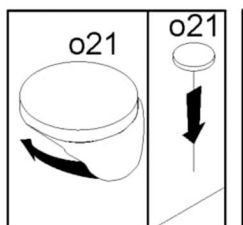
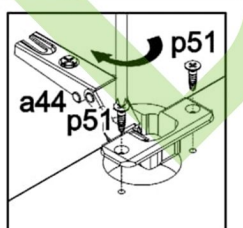
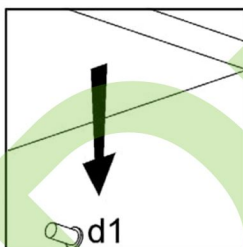
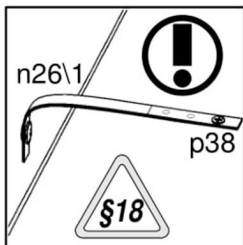
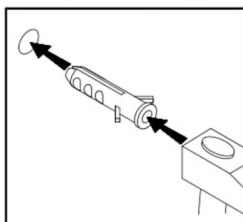
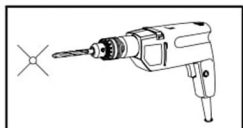

# 4 МОДЕН-Р

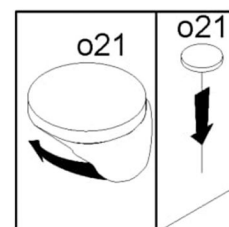
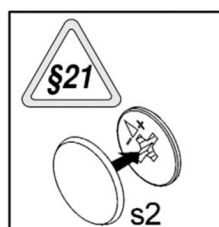
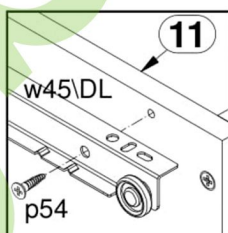
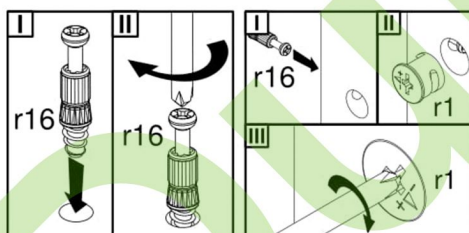
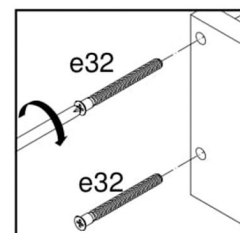
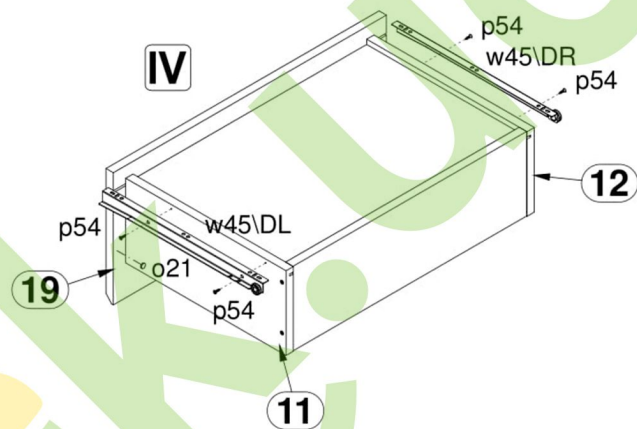
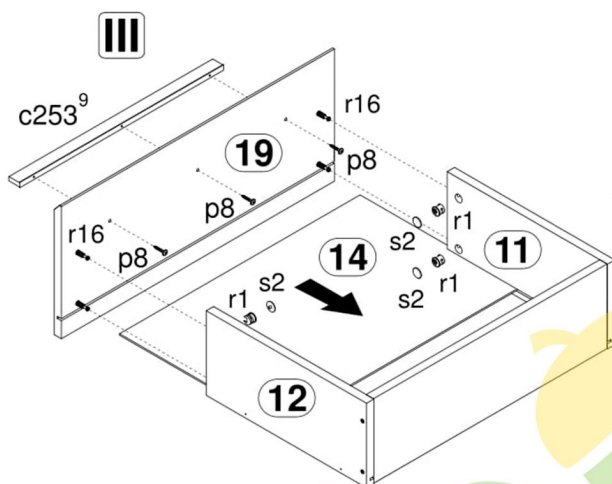
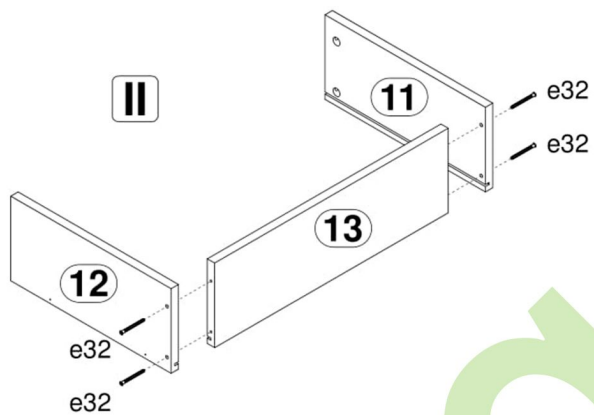
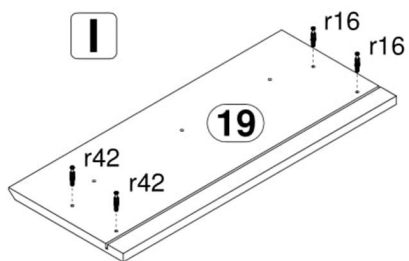

# 5 МОДЕН-Р

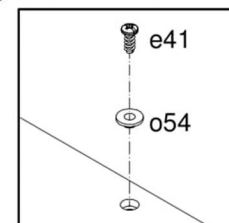
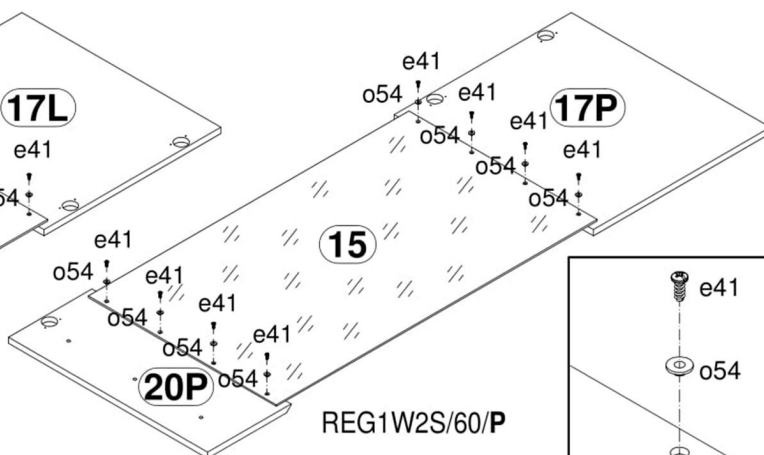
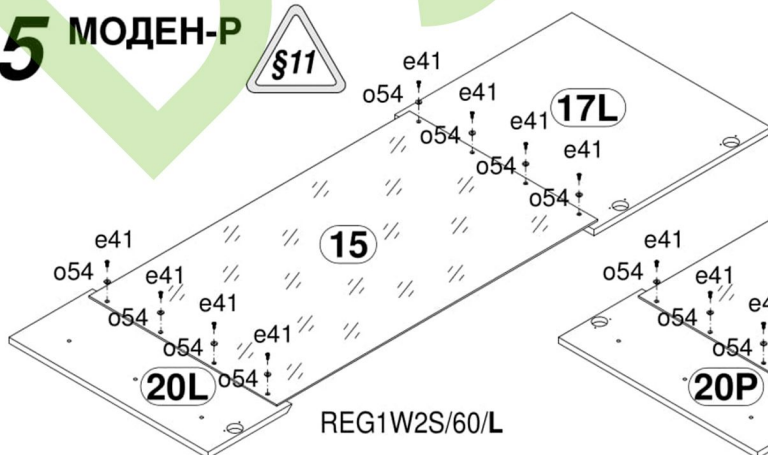

# 6 МОДЕН-Р REG1W2S/60/L

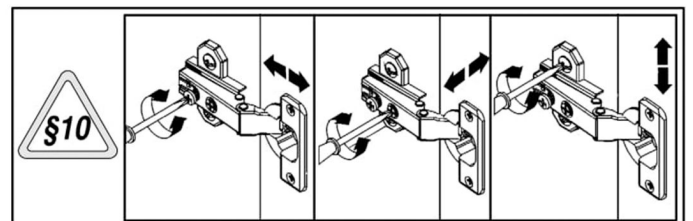
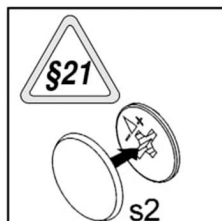
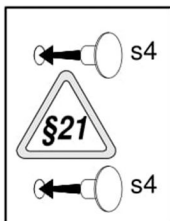
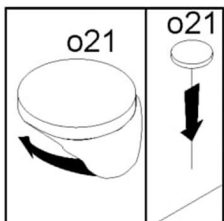
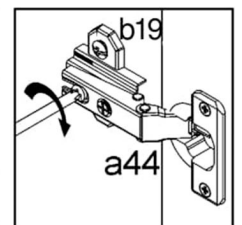
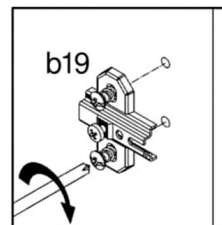
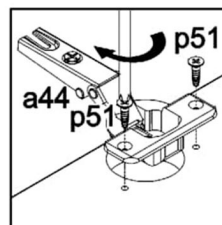
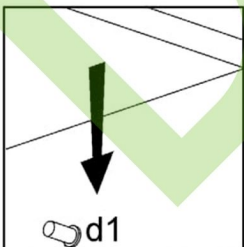
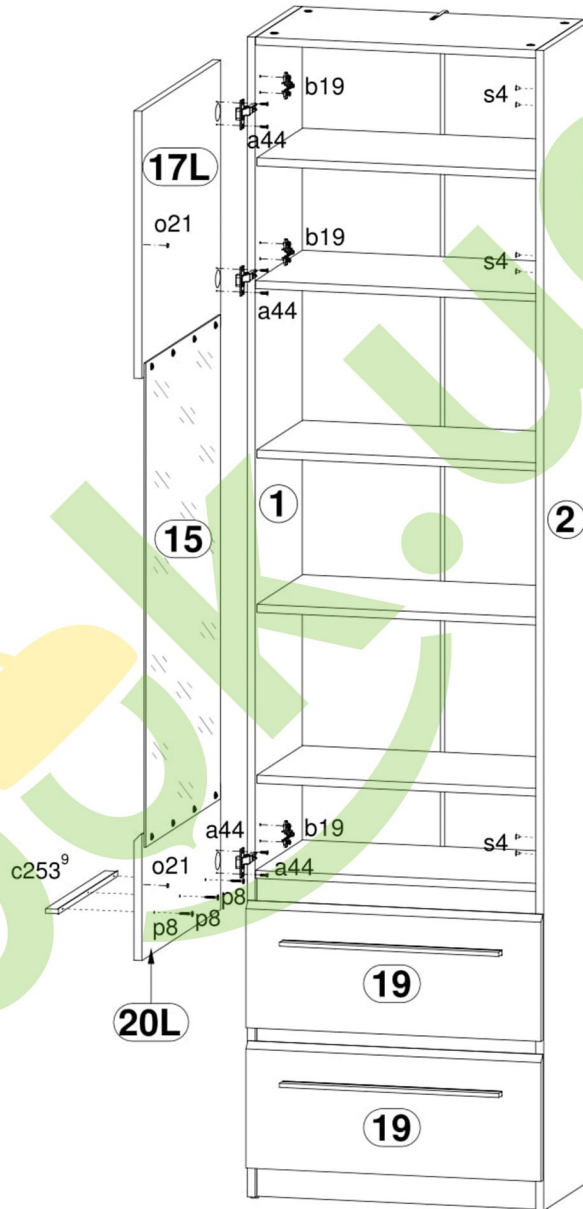
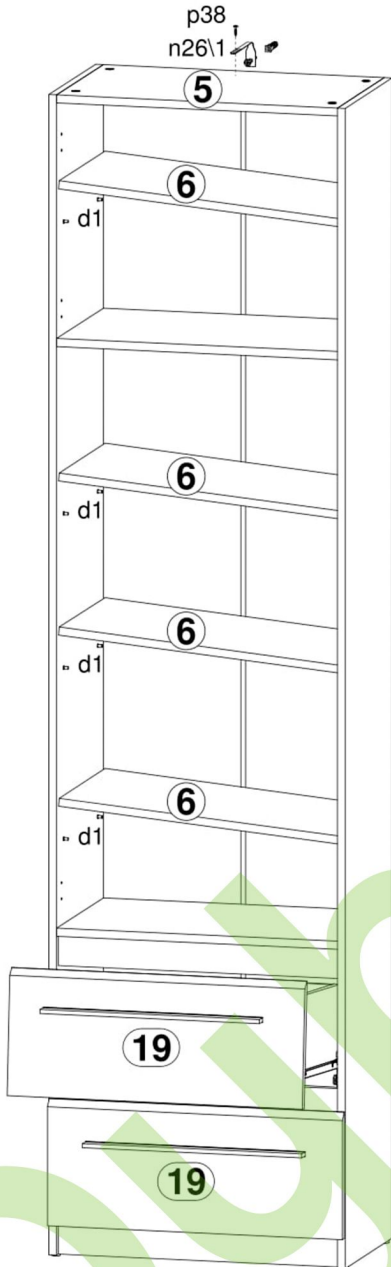
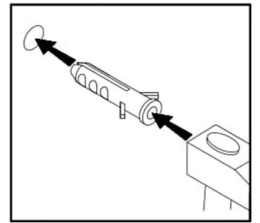
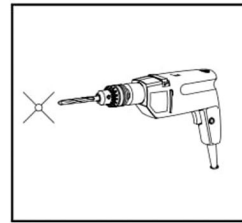
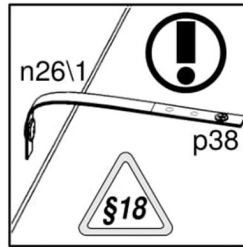

# 6 МОДЕН-Р REG1W2S/60/P

