

# CHEST OF DRAWERS

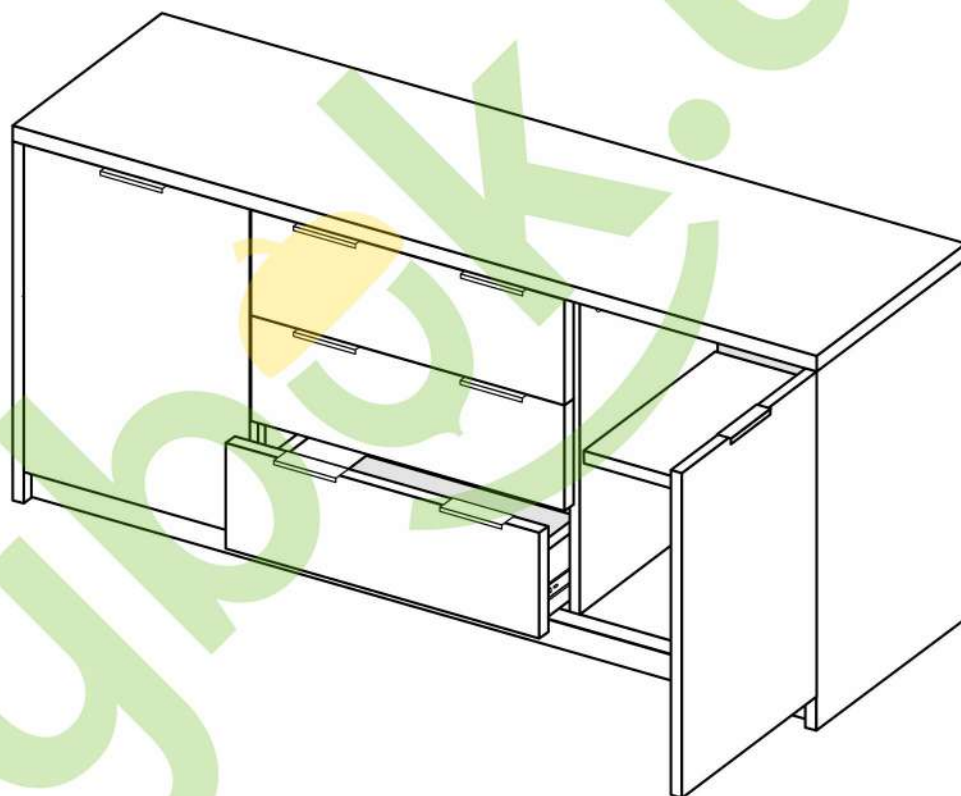

M0035

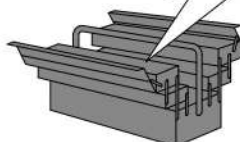
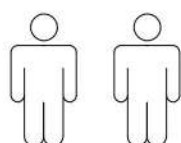

1

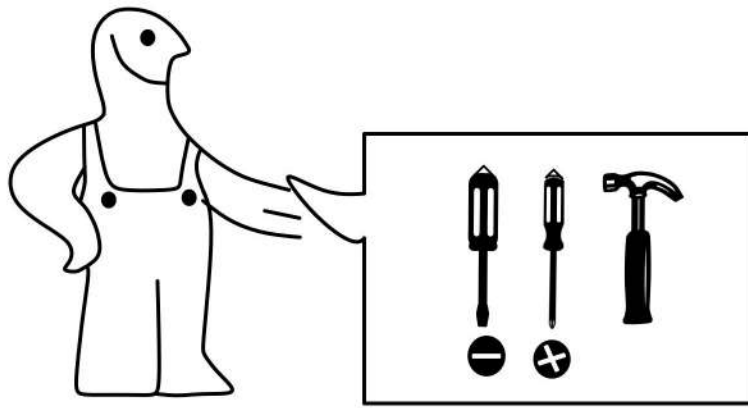

2

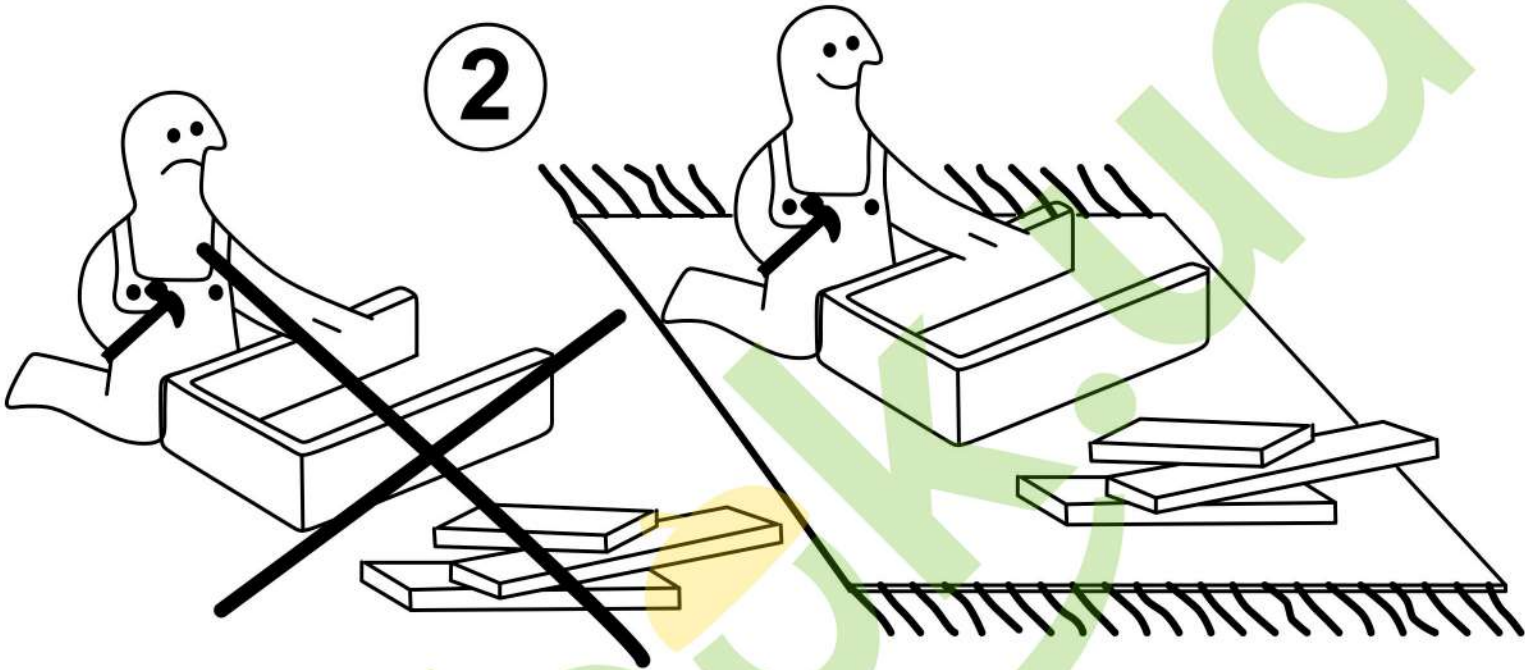

3



4

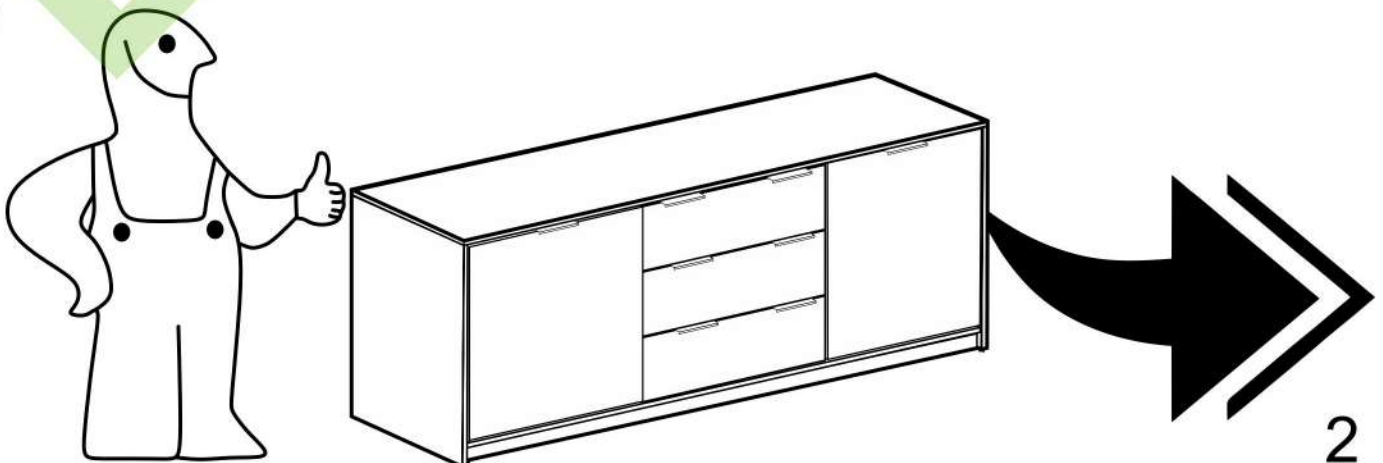

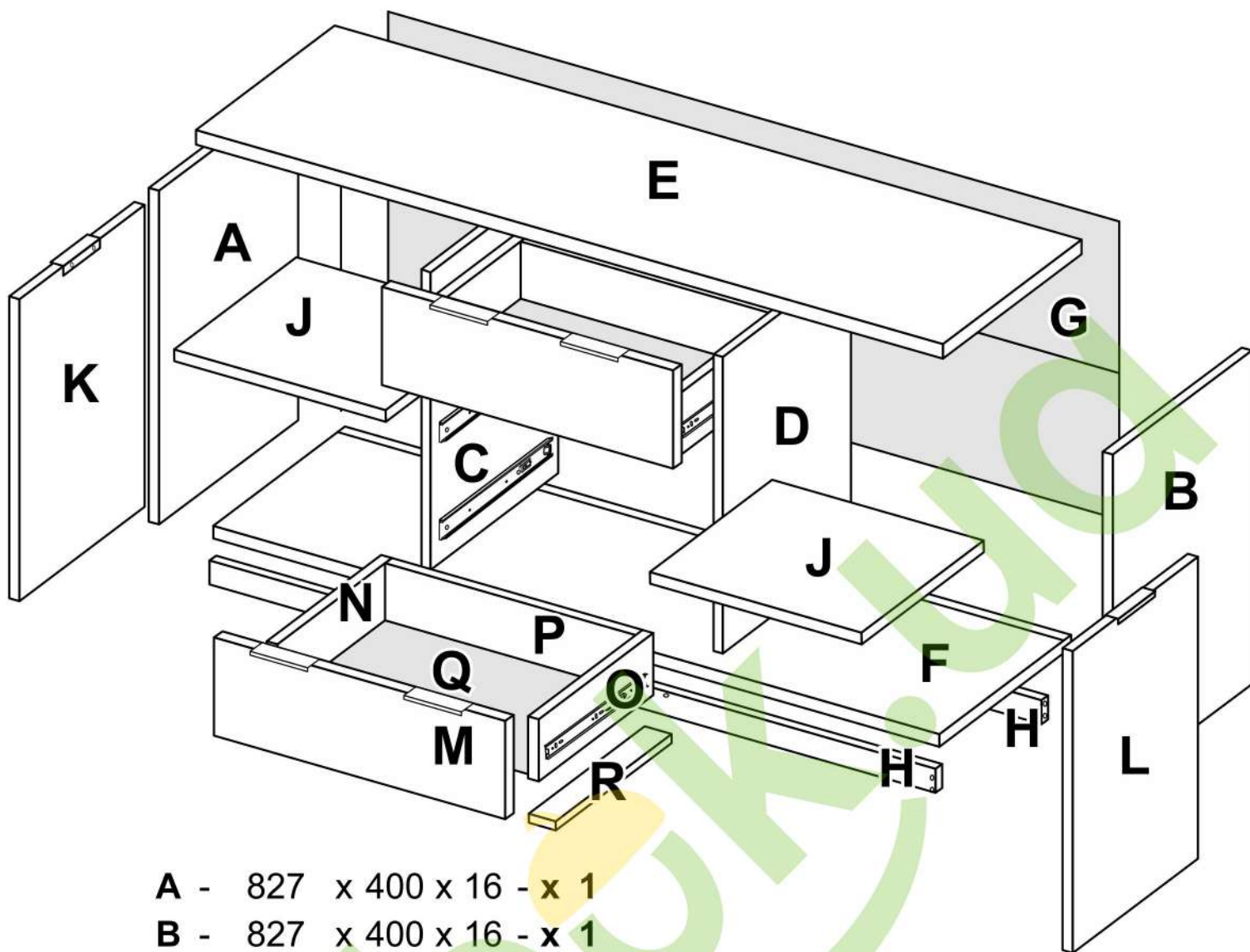

- A - 827 x 400 x 16 - x 1
- B - 827 x 400 x 16 - x 1
- C - 761 x 366 x 16 - x 1
- D - 761 x 366 x 16 - x 1
- E - 1998 x 401 x 16 - x 1
- F - 1964 x 380 x 16 - x 1
- G - 1976 x 386 x 3 - x 2
- H - 1964 x 50 x 16 - x 2
- J - 356 x 443 x 16 - x 2
- K - 444 x 771 x 18 - x 1
- L - 444 x 771 x 18 - x 1
- M - 255 x 1062 x 18 - x 3
- N - 350 x 136 x 16 - x 3
- O - 350 x 136 x 16 - x 3
- P - 988 x 136 x 16 - x 3
- Q - 346 x 1000 x 3 - x 3
- R - 334 x 100 x 16 - x 3



