

ОПЕН

Стіл журнальний / Стол журнальный_LAW 115

A	B	C		D
1	S133-159	460	476	1/1
2	S133-203	1150	600	1/1
3	S133-359	880	464	1/1
4	S133-422	880	80	1/1

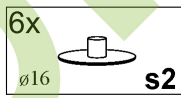
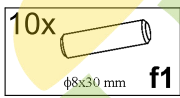
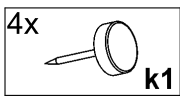
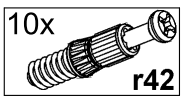
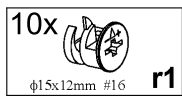
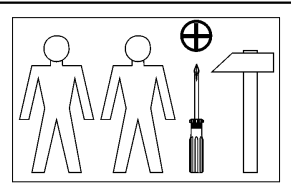
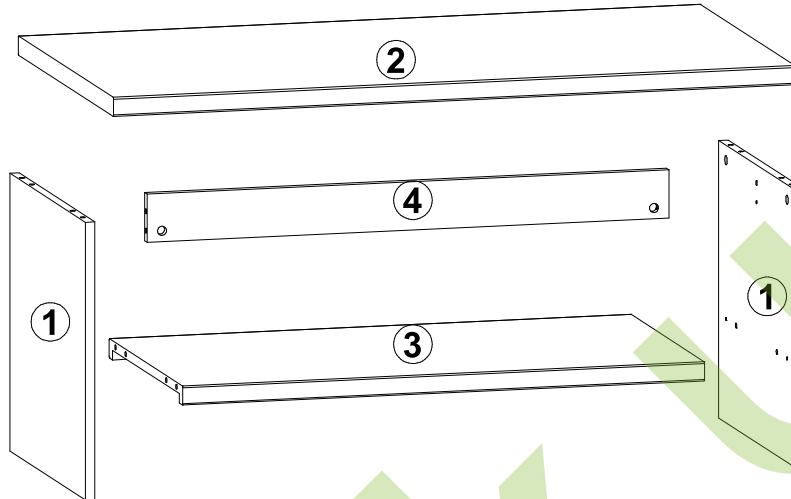

1 §2

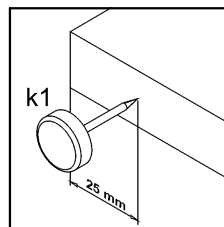
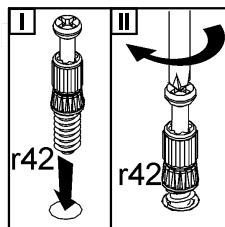
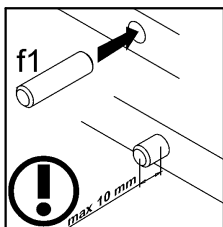
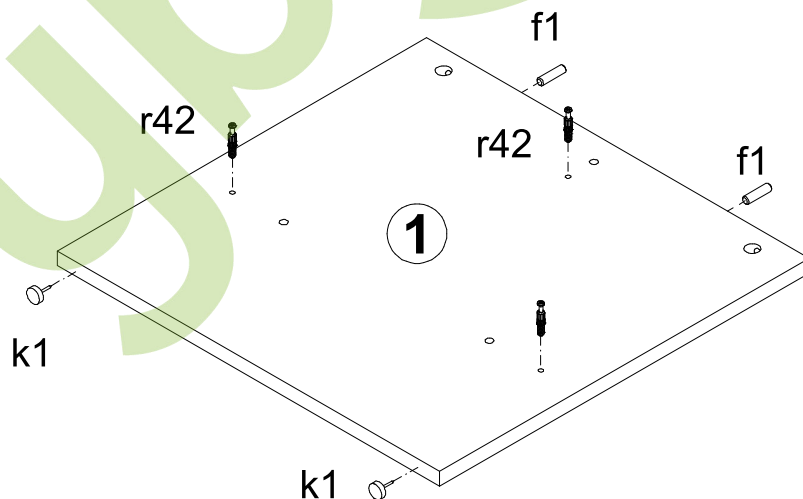

2

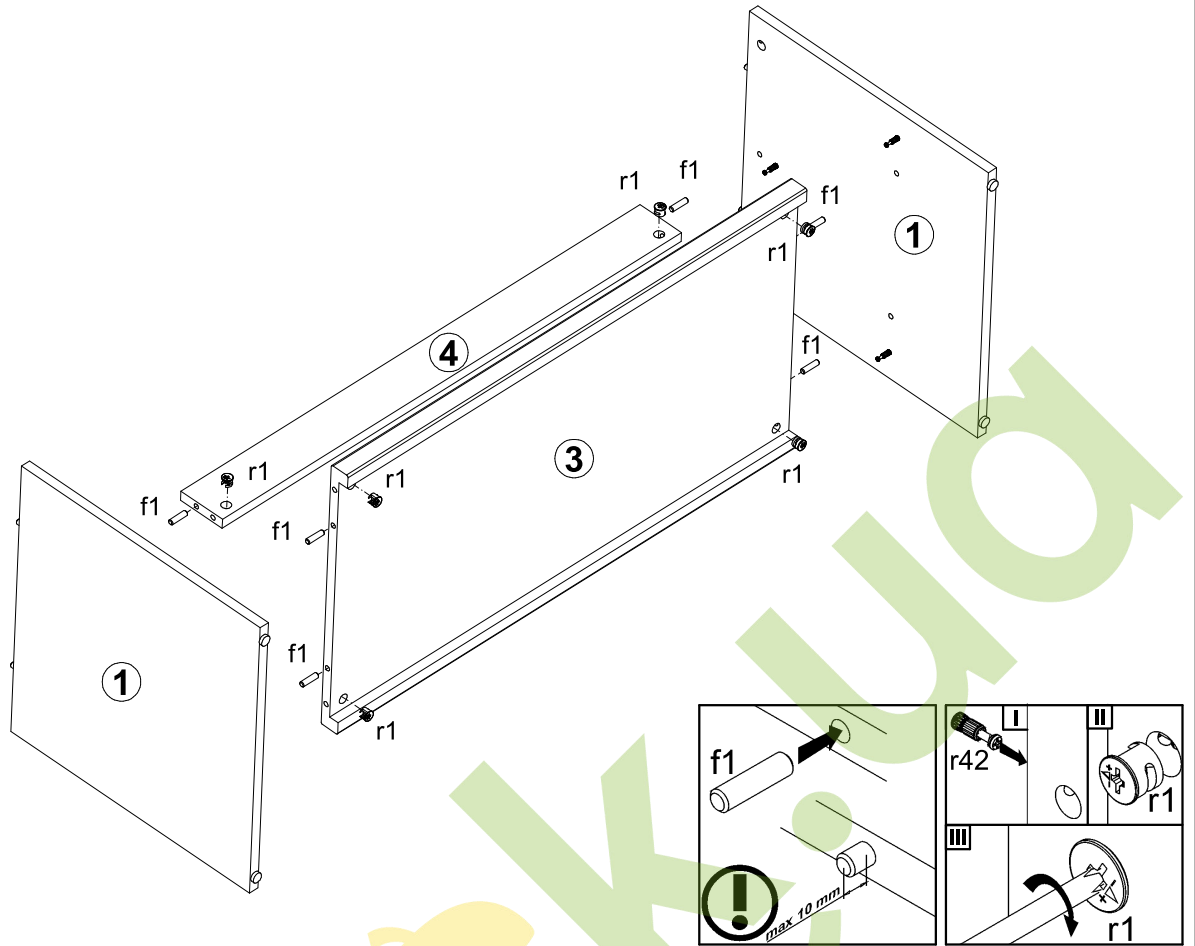

3

