

ОПЕН

Вітрина / Витрина _ REG 1W1S

A	B	C		D
1	S133-009	495	180	3/4
2	S133-011	1680	492	4/4
3	S133-111-01	1995	332	1/4
4	S133-112-01	1995	332	1/4
5	S133-310	500	326	1/4
6	S133-313	500	304	1/4
7	S133-403	500	76	1/4
8	S133-552	498	300	2/4
9	S133-907	458	299	1/4
10	S133-929	1698	527	4/4
11	S133-930	198	527	1/4
12	S133-507	300	120	1/4
13	S133-508	300	120	1/4
14	S133-5548	443	120	1/4
15	S133-426	500	120	1/4

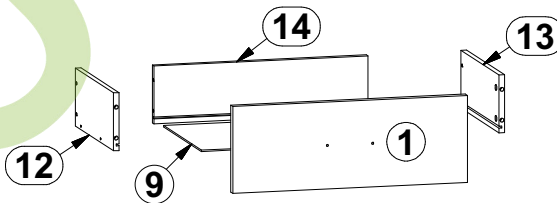
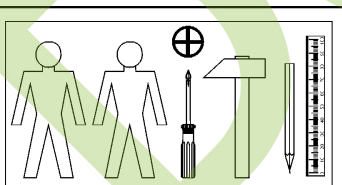
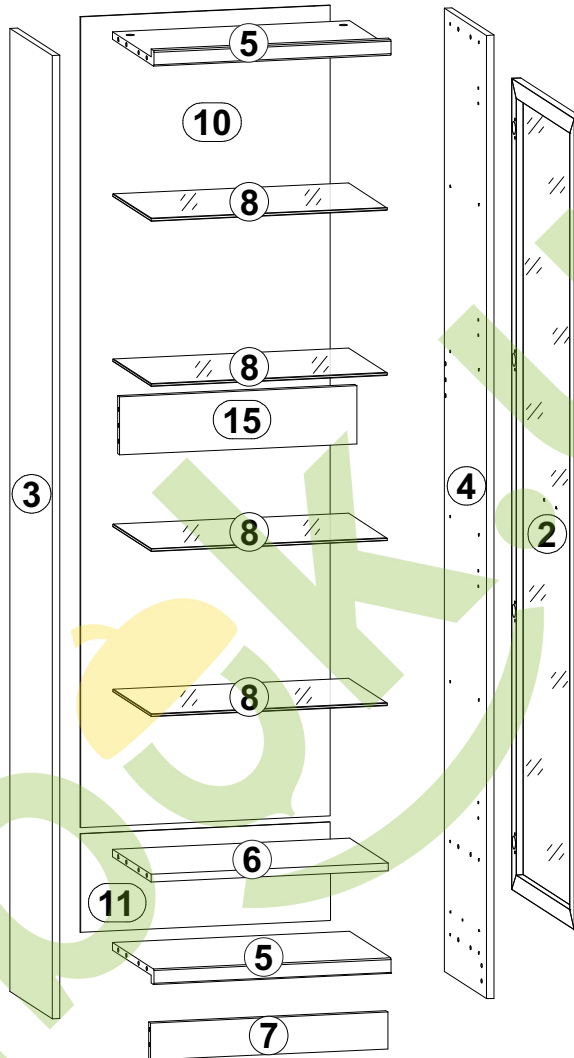
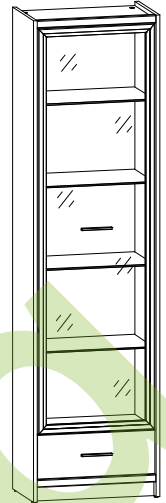
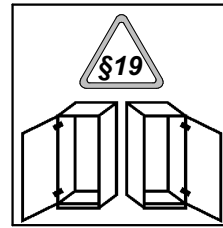

4x a1	4x b1	2x c 22317 126 mm	16x d3 φ5x17 mm	4x e19 φ5x9 mm	6x e3 φ6x13 mm	18x f1 φ8x30 mm	4x e32 φ5x50 mm	4x k1
60x l1	2x o47 φ5/φ7x5,4	2x p37 φ3x13 mm	2x p50 φ2,2x24 mm	20x r1 φ1,5x12mm #16	4x s2 Ø16	8x s4	20x r42	1x w37\CL 300 mm
1x w37\CR 300 mm	1x w37\DL 300 mm	1x w37\DR 300 mm	1x n26\1	5x p38 φ3,5x16 mm				

3

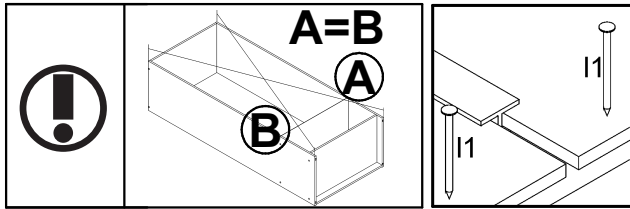
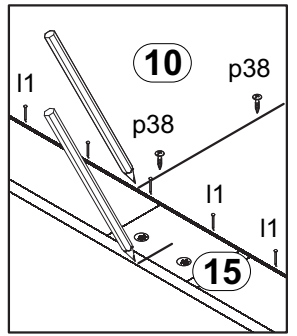
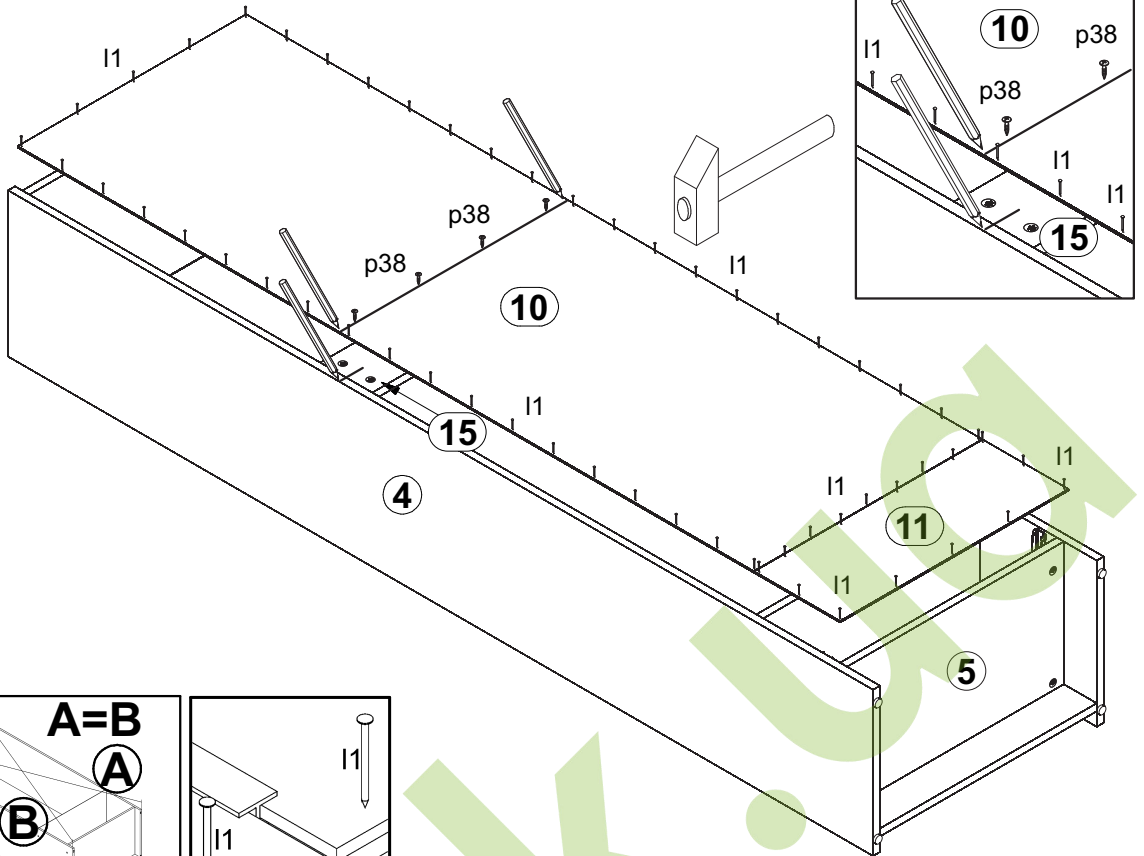
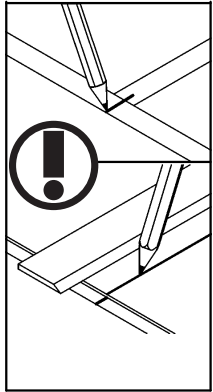

4

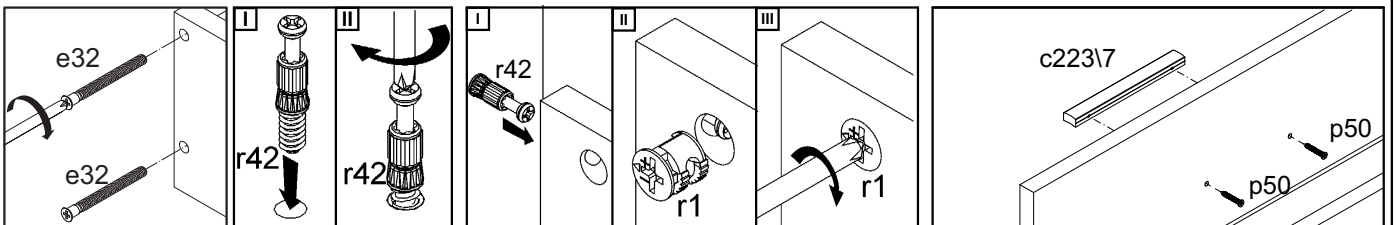
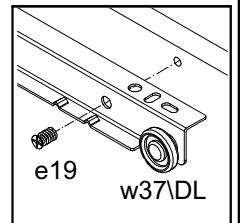
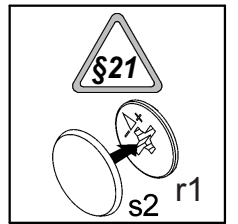
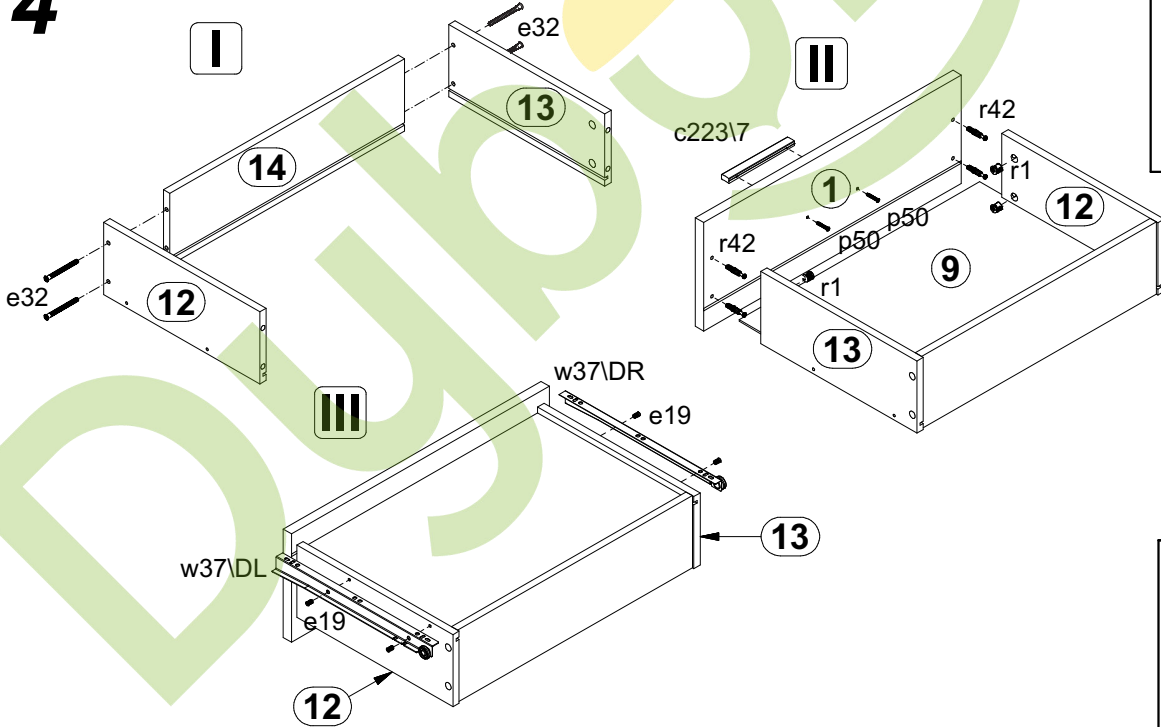

5 §11

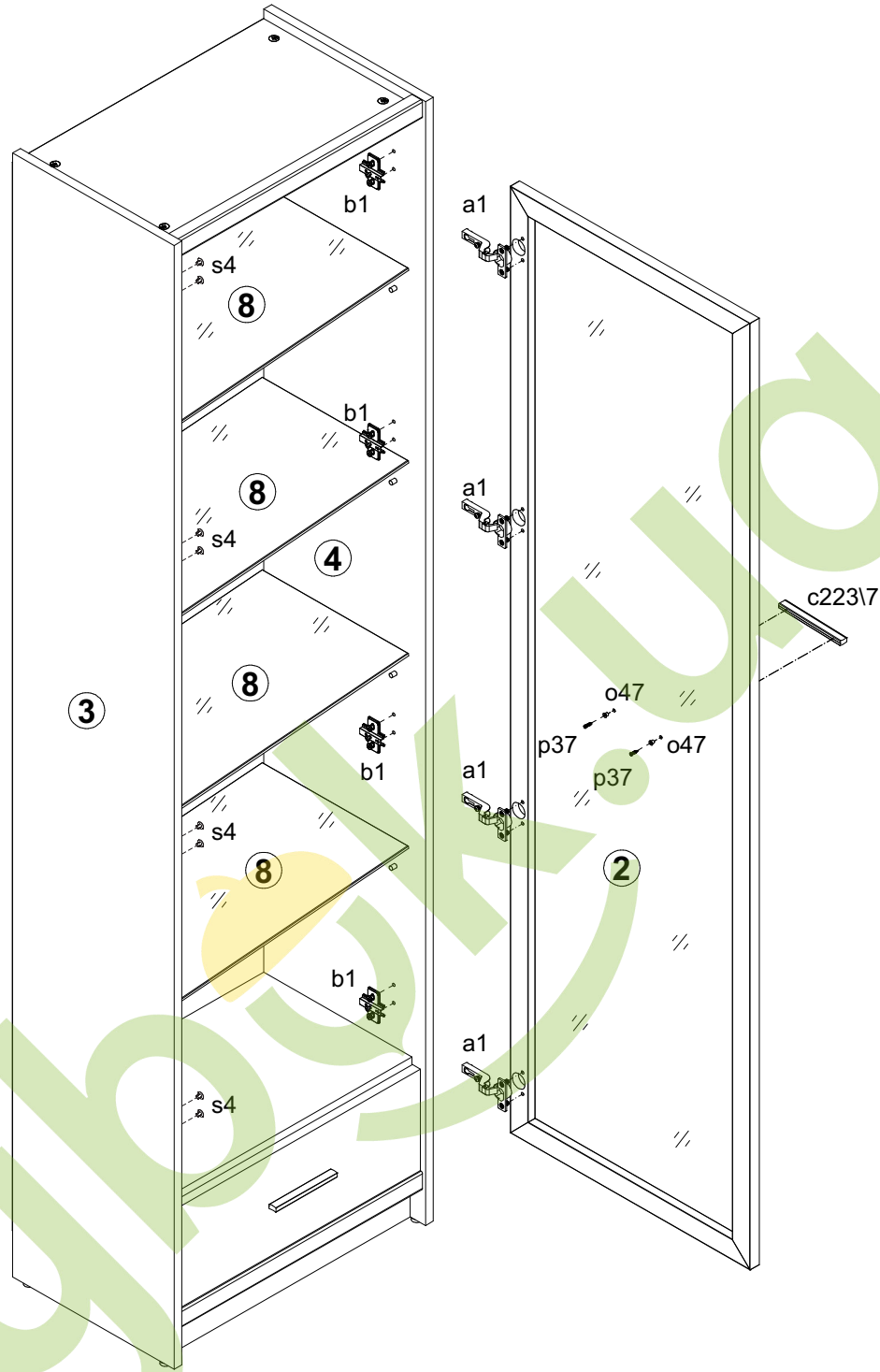
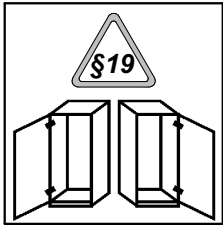
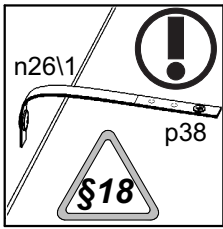

§21

