

A	B	C	D
1	S19-3307	450x320	1/1
2	S19-3308	450x320	1/1
3	S19-1157	1500x310	1/1
4	S19-569	1975x350	1/1
5	g33-SRE	500x100	1/1

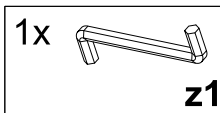

1

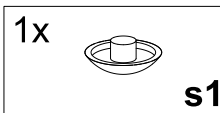
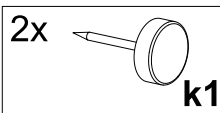
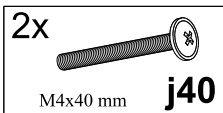
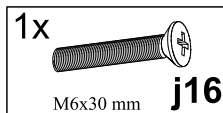
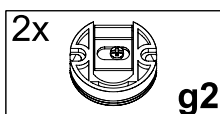
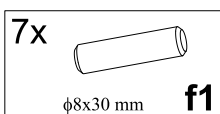
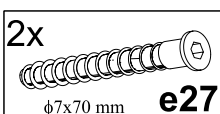
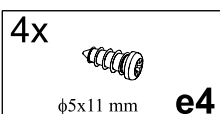
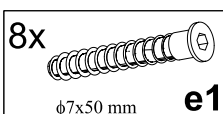
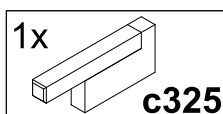
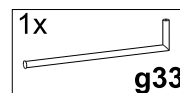
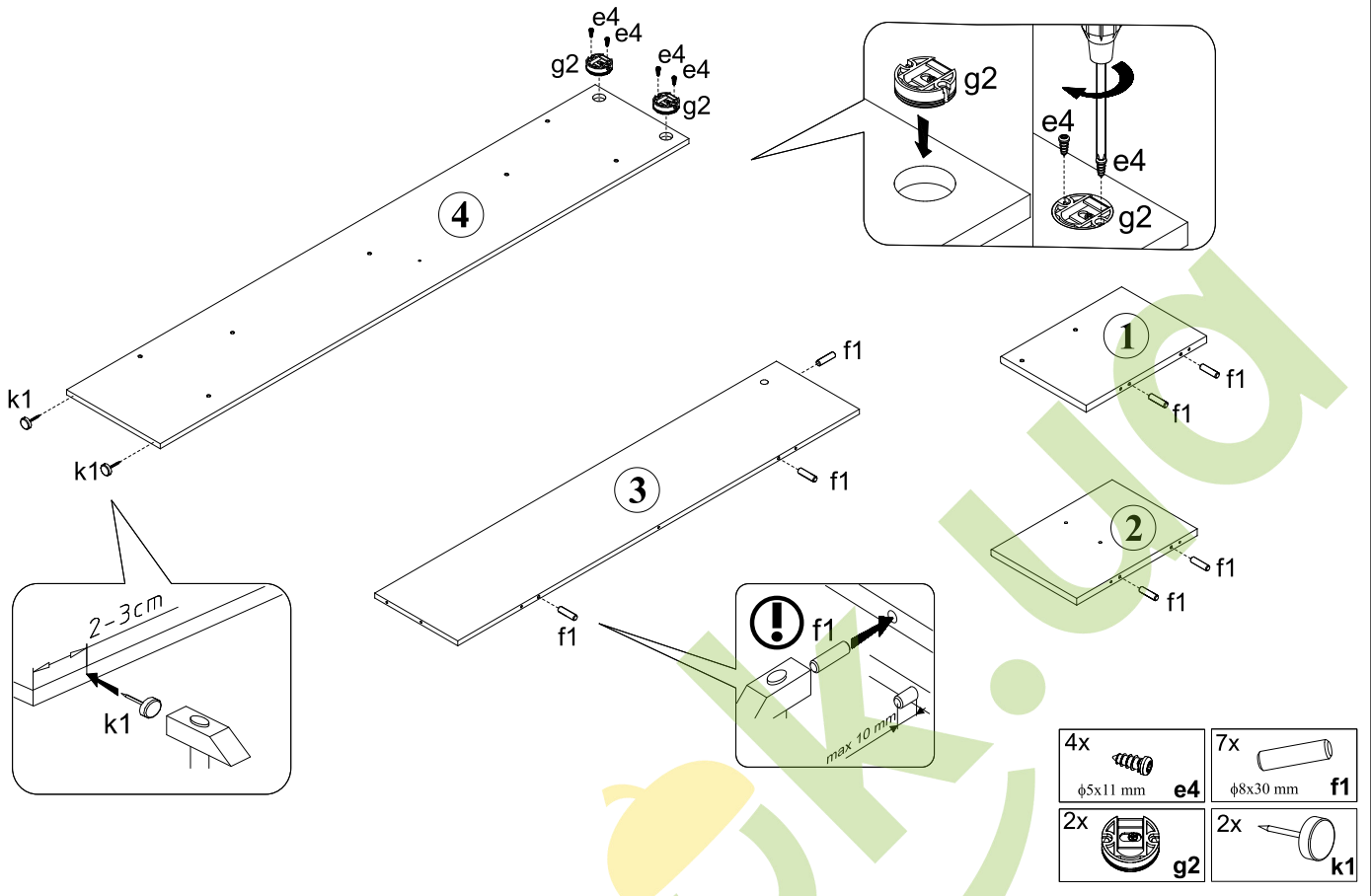

2

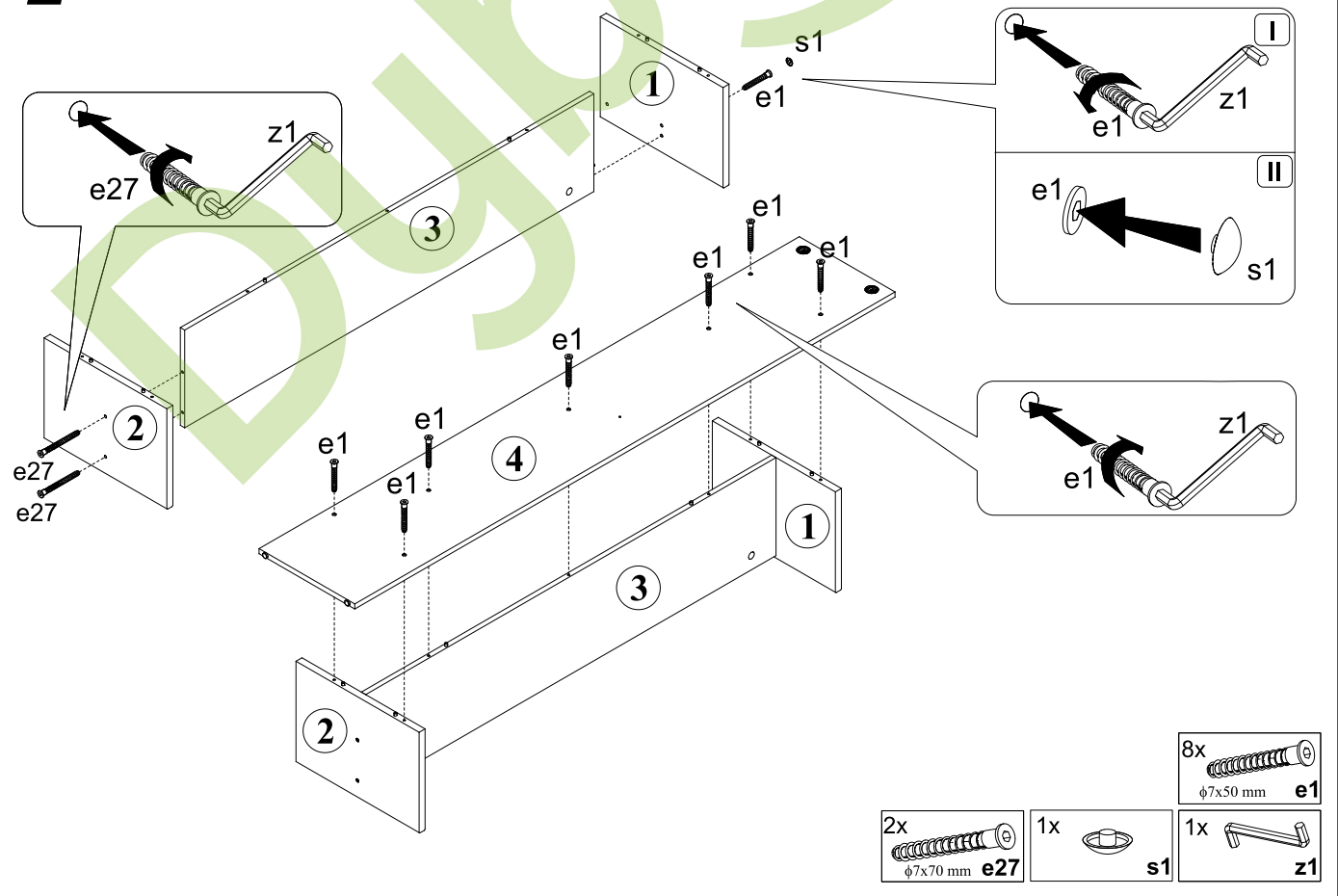

3

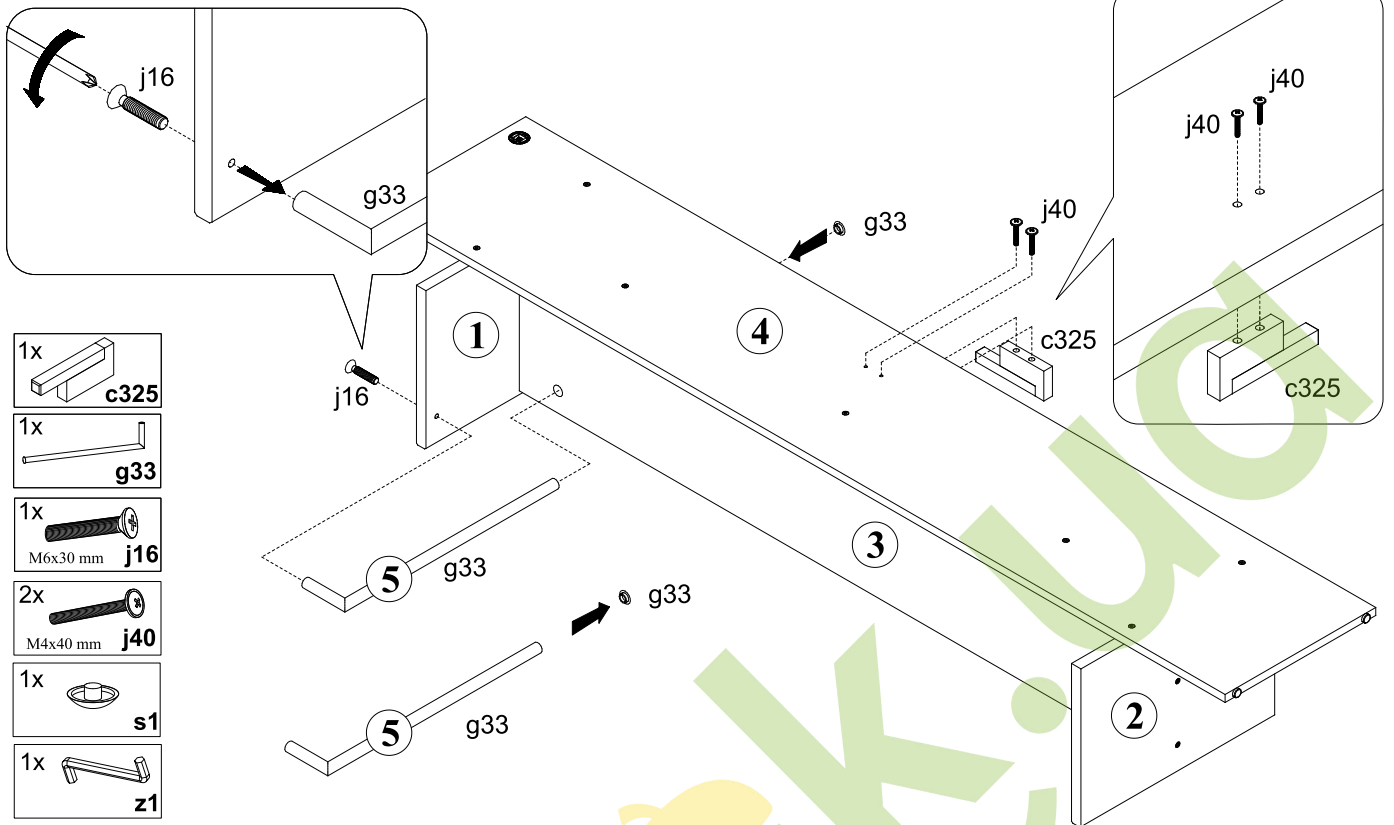

4

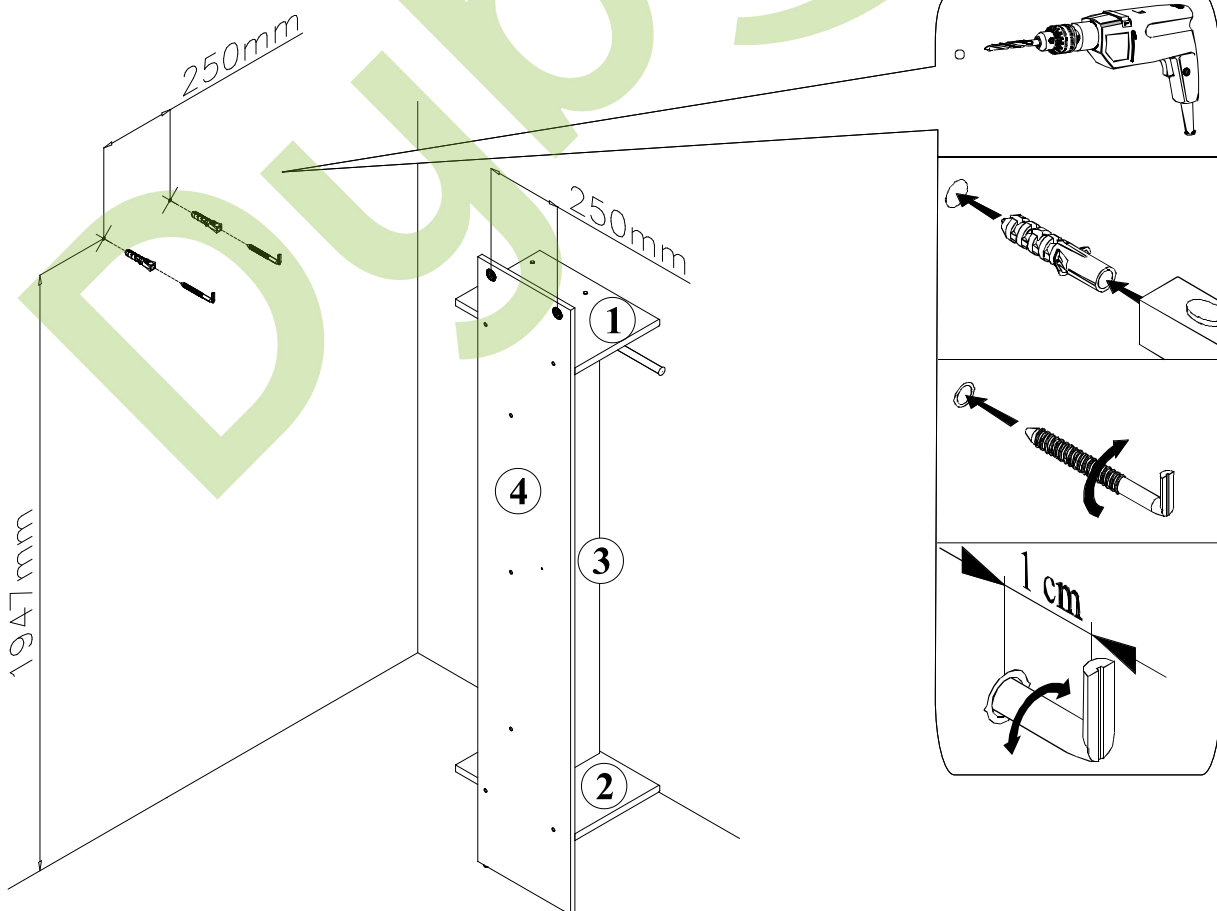

5

