

Граф / Graf

Вітрина / Витрина **REG2W2D**

A	B	C	D
1	S359-0015-01	486	415 6/6
2	S359-0016-01	486	415 6/6
3	S359-0017-01	415	175 6/6
4	S359-0018-01	415	175 6/6
5	S359-0019-01	415	175 6/6
6	S359-0020-01	415	175 6/6
7	S359-1021	1872	435 1/6
8	S359-1022	1872	435 1/6
9	S359-1023	1856	415 1/6
10	S359-2006	1020	468 2/6

A	B	C	D
11	S359-3011	966	435 2/6
12	S359-3012	475	415 3/6
13	S359-3014	474	409 3/6
14	S359-3015	475	415 3/6
15	S359-5015	999	80 4/6
16	S359-5016	999	80 4/6
17	S359-5017	1712	80 4/6
18	S359-5018	1712	80 4/6
19	S359-5019	944	415 5/6
20	S359-9510	1869	488 1/6
21	S359-9511	1869	488 1/6

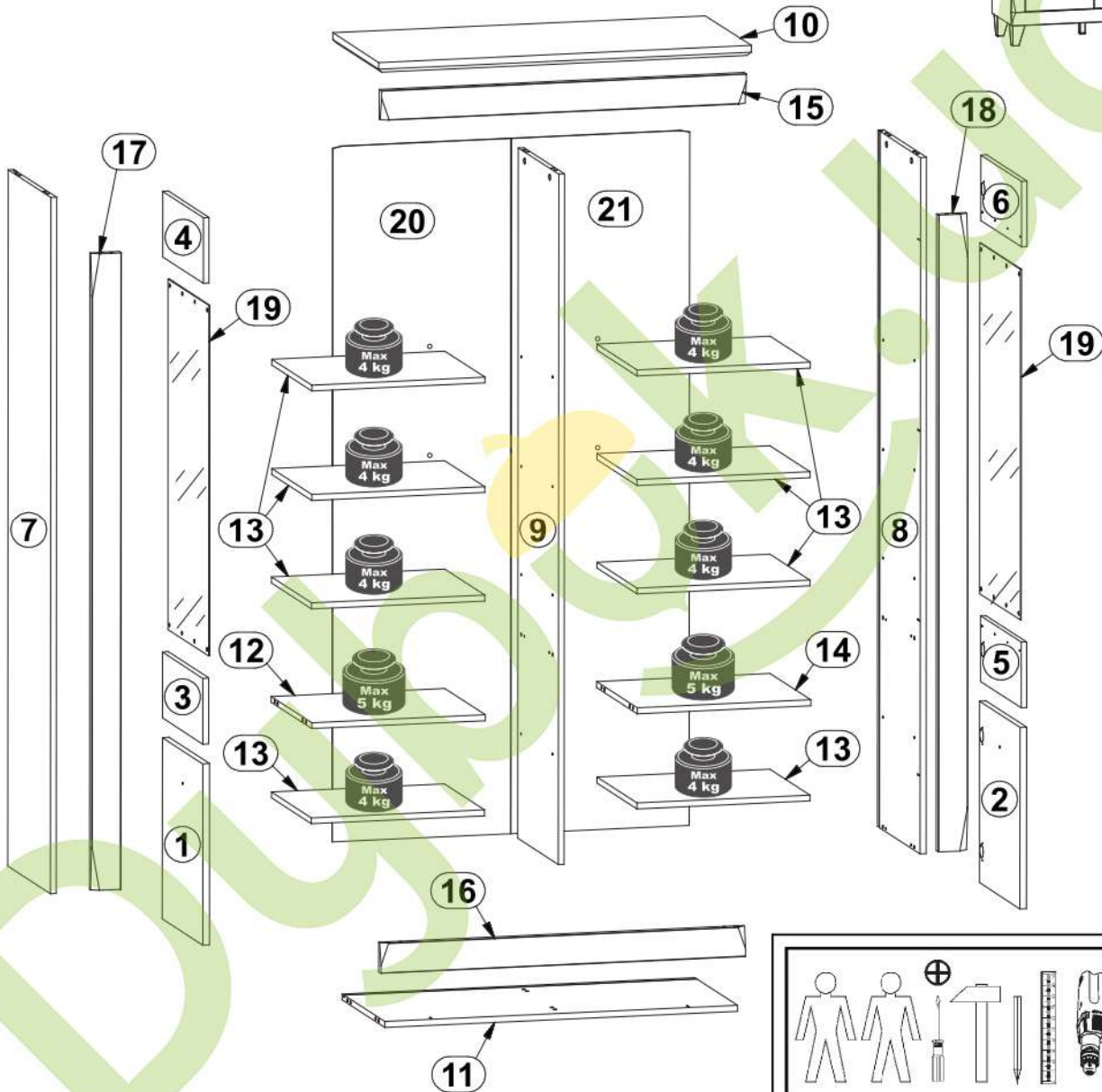
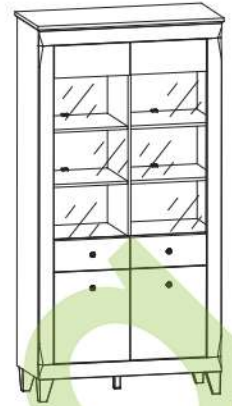

4x a63/1	8x a132	4x a133	8x b78	4x c415	32x d1	12x d37	2x e1	17x e2
16x e41	12x e58	28x f1	2x j1	2x j30	1x k3813	1x k3817	4x k125	10x l1
14x l2	1x n26/1	7x n108	16x o54	1x o70/6	4x o114	53x p38	7x p55	8x p51
8x p143	18x r1	18x r16	6x s2	1x z1	1x			

1

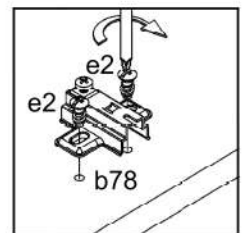
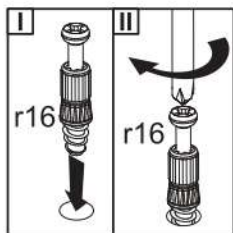
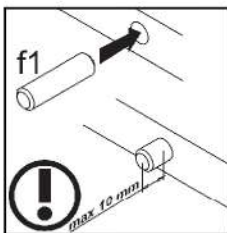
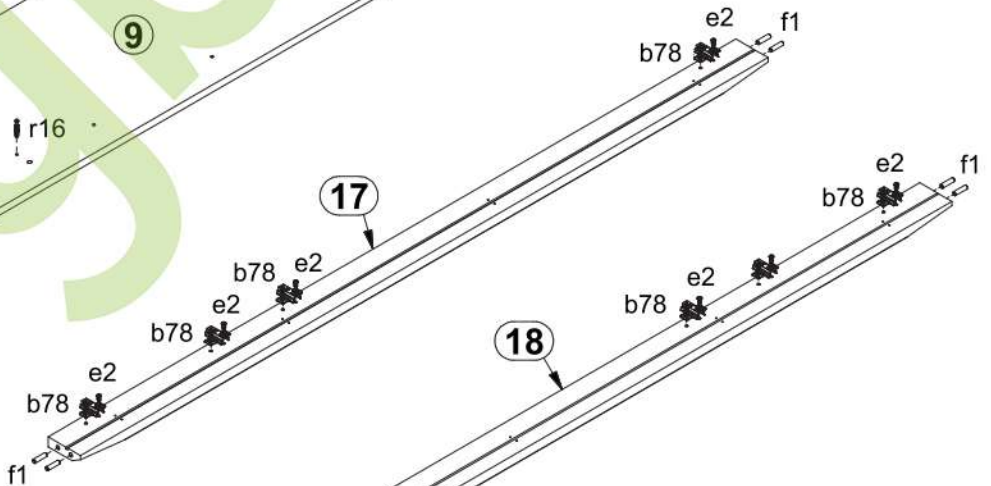
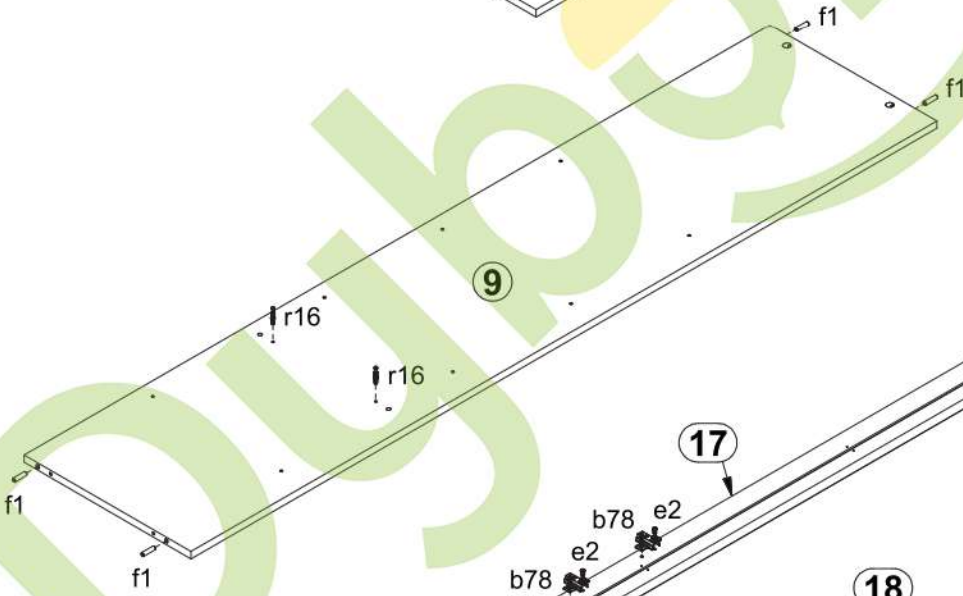
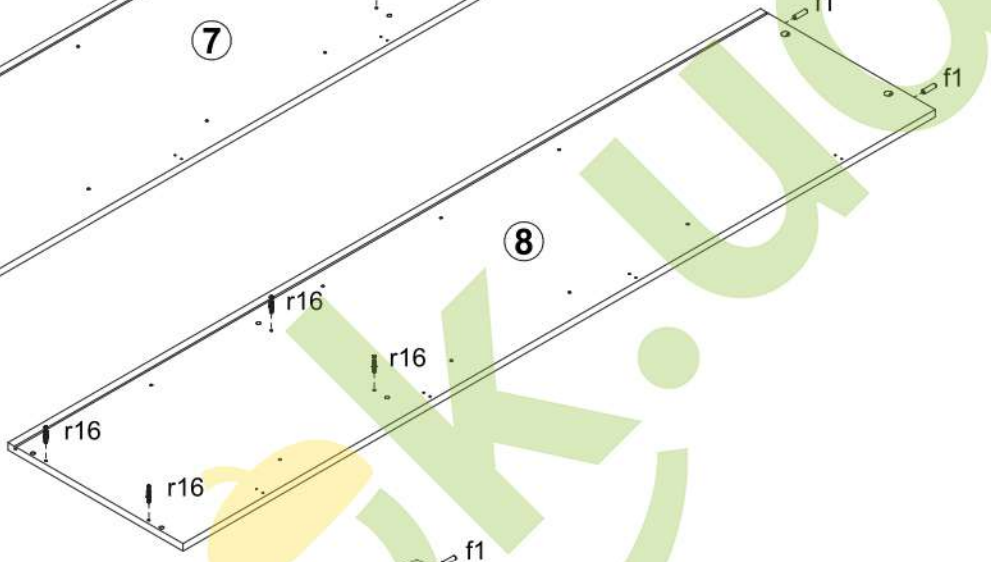
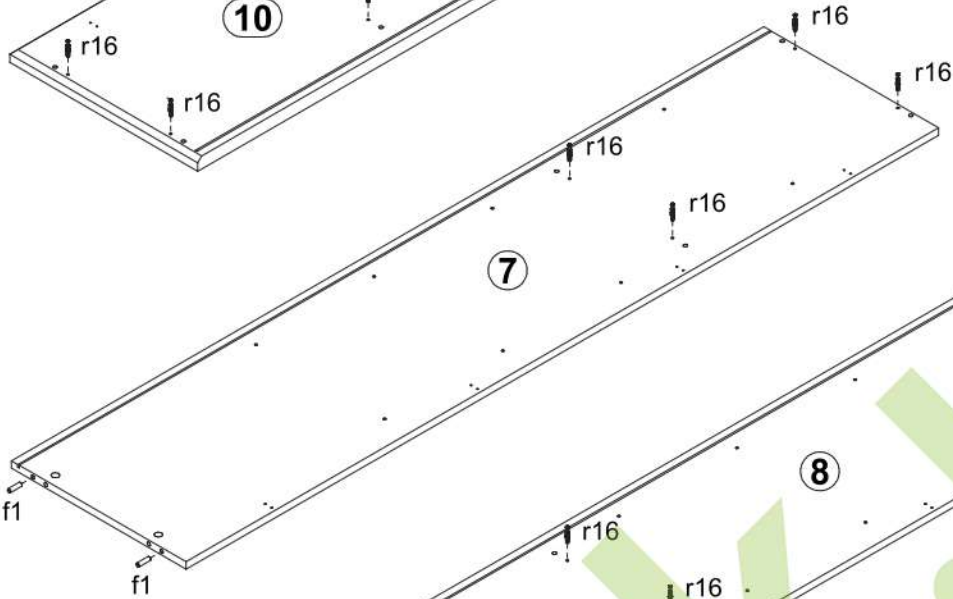
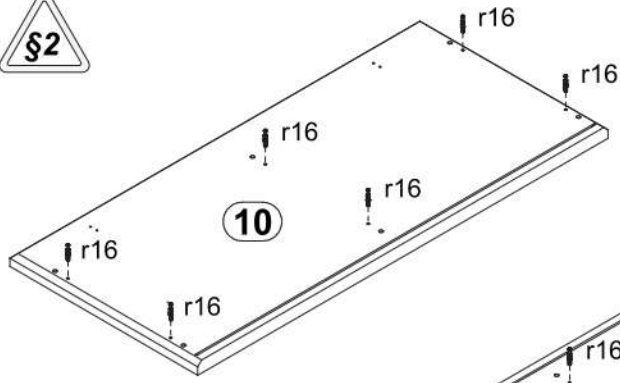

2 

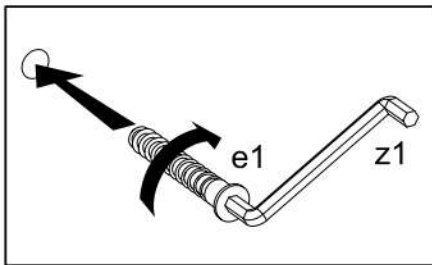
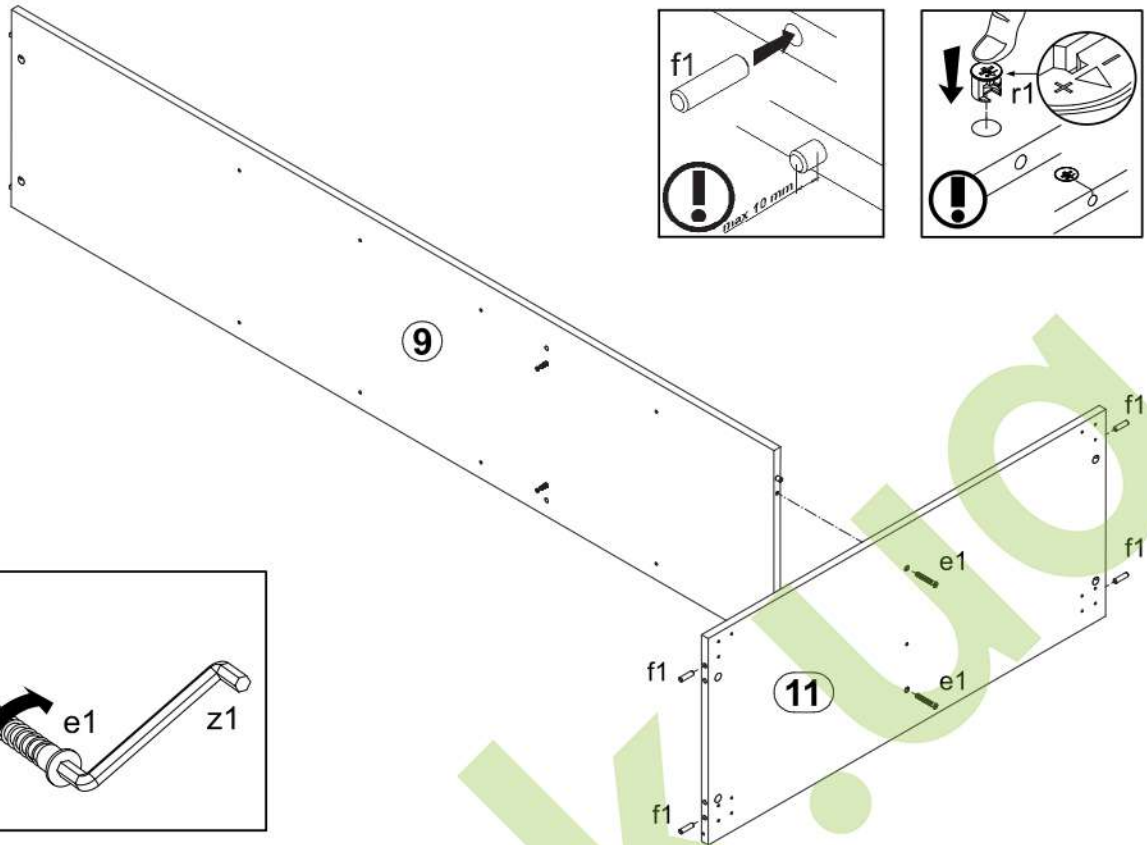

3

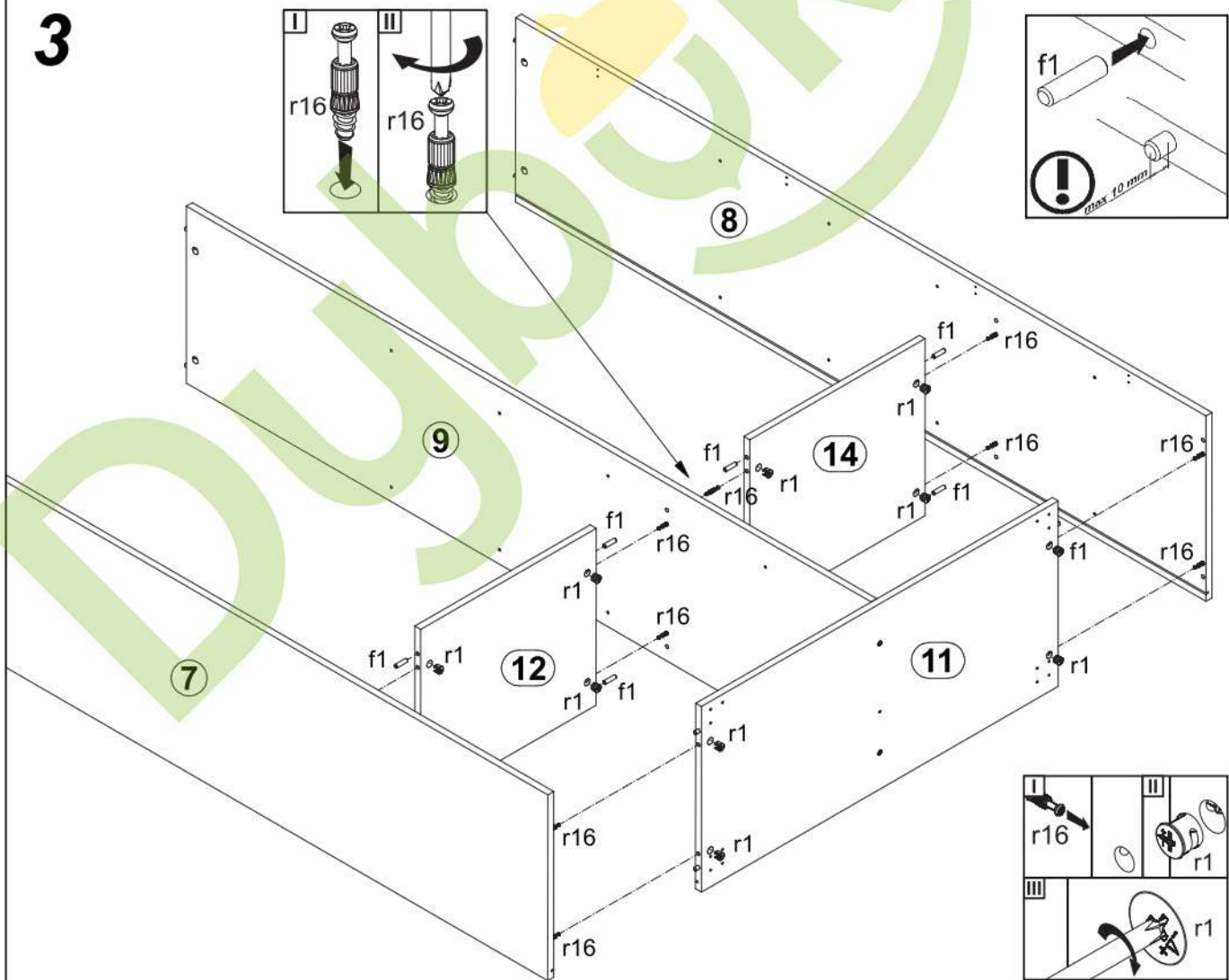

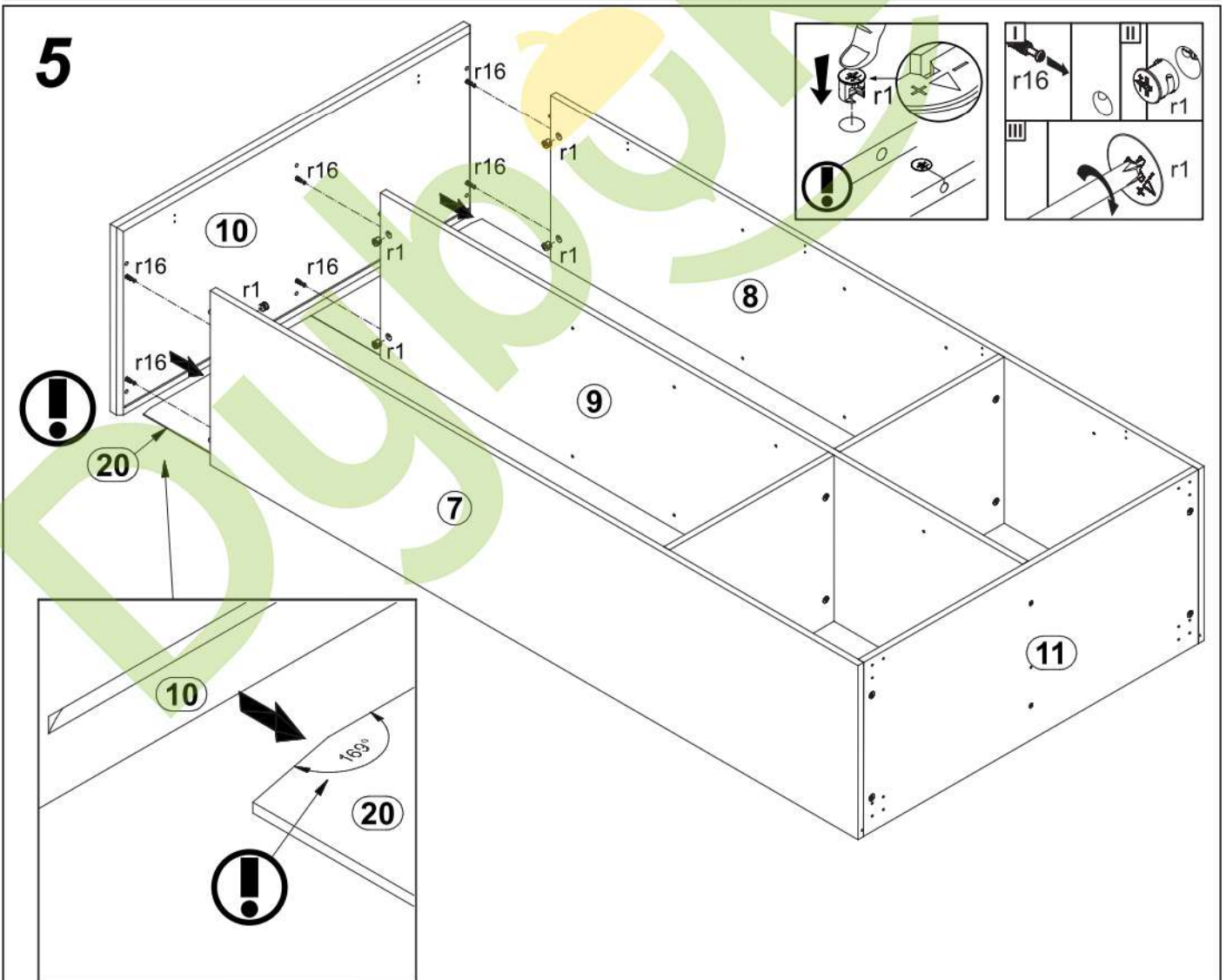
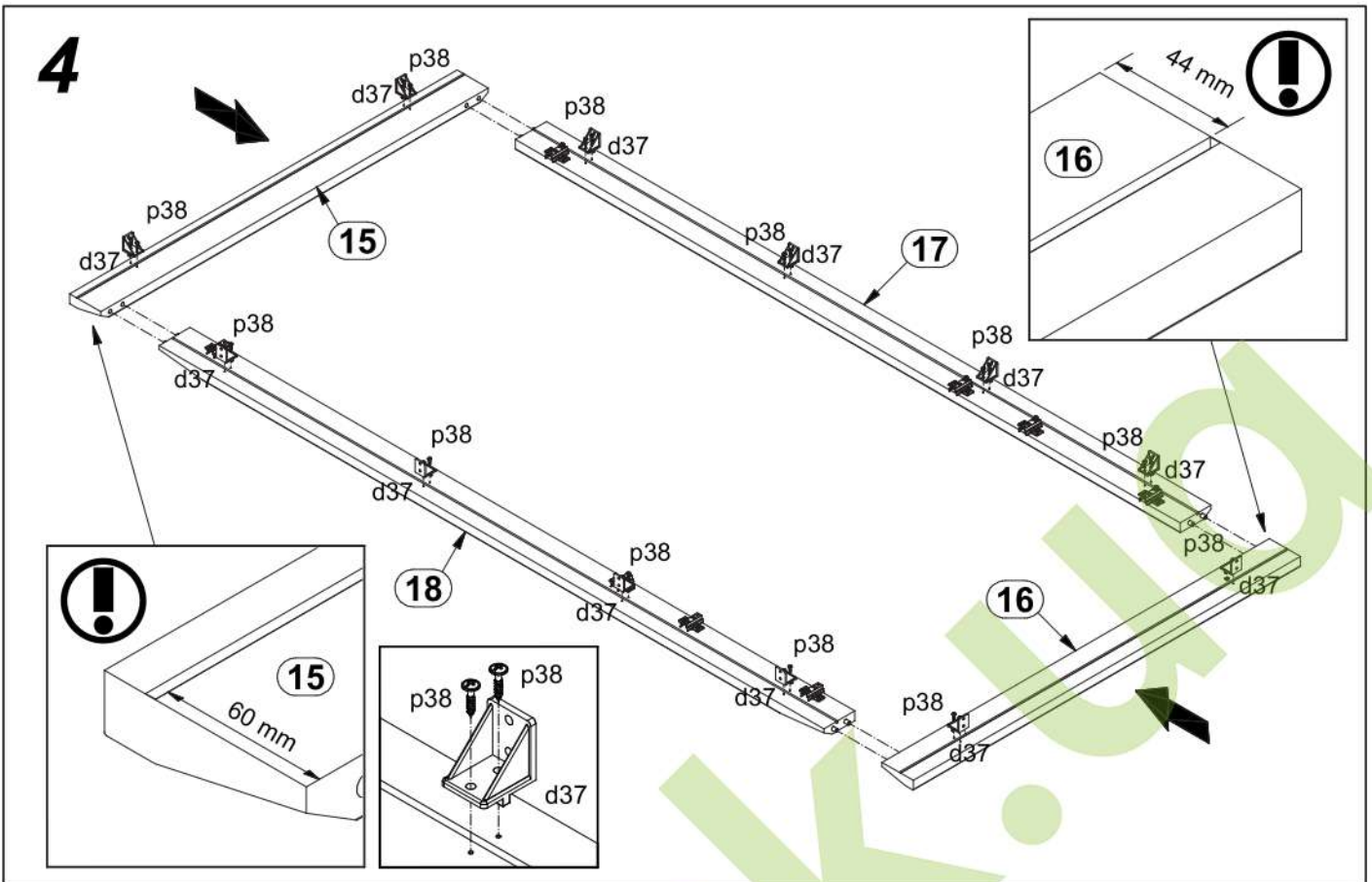

6

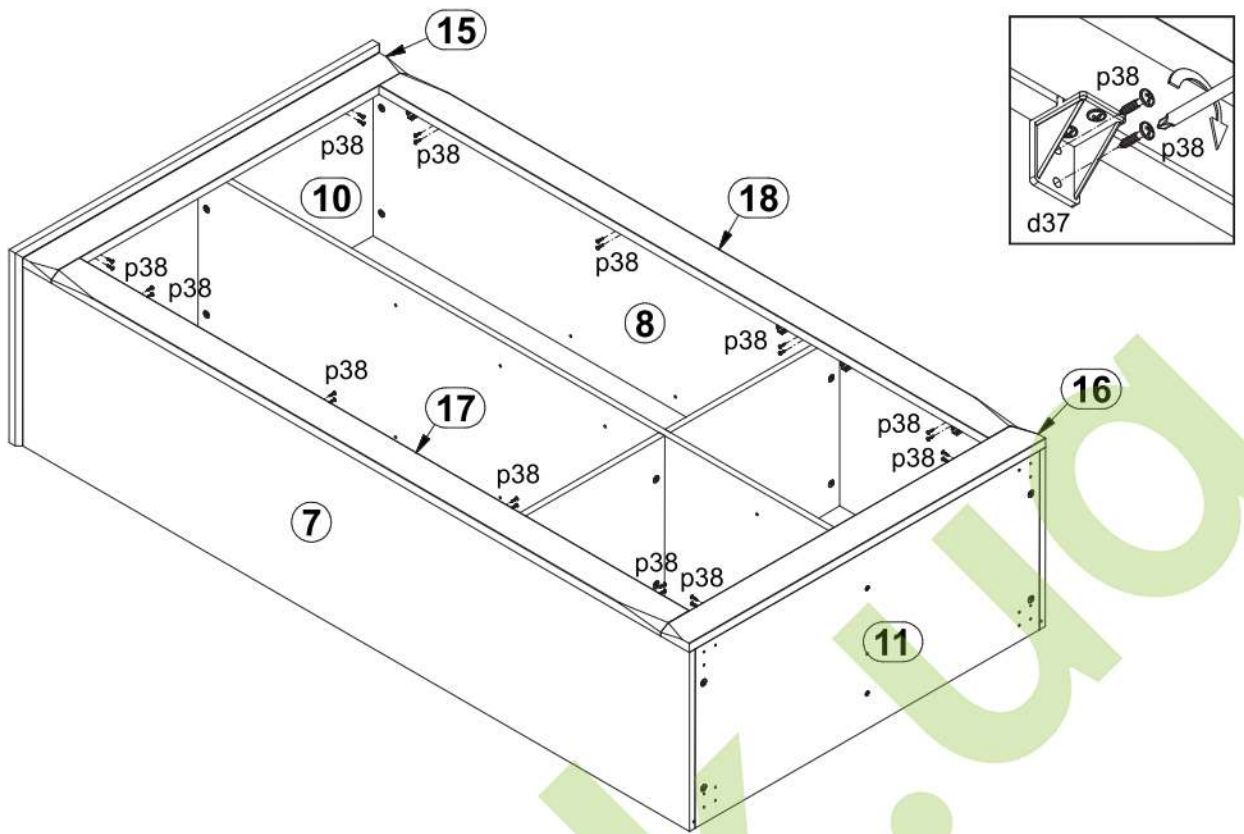

7

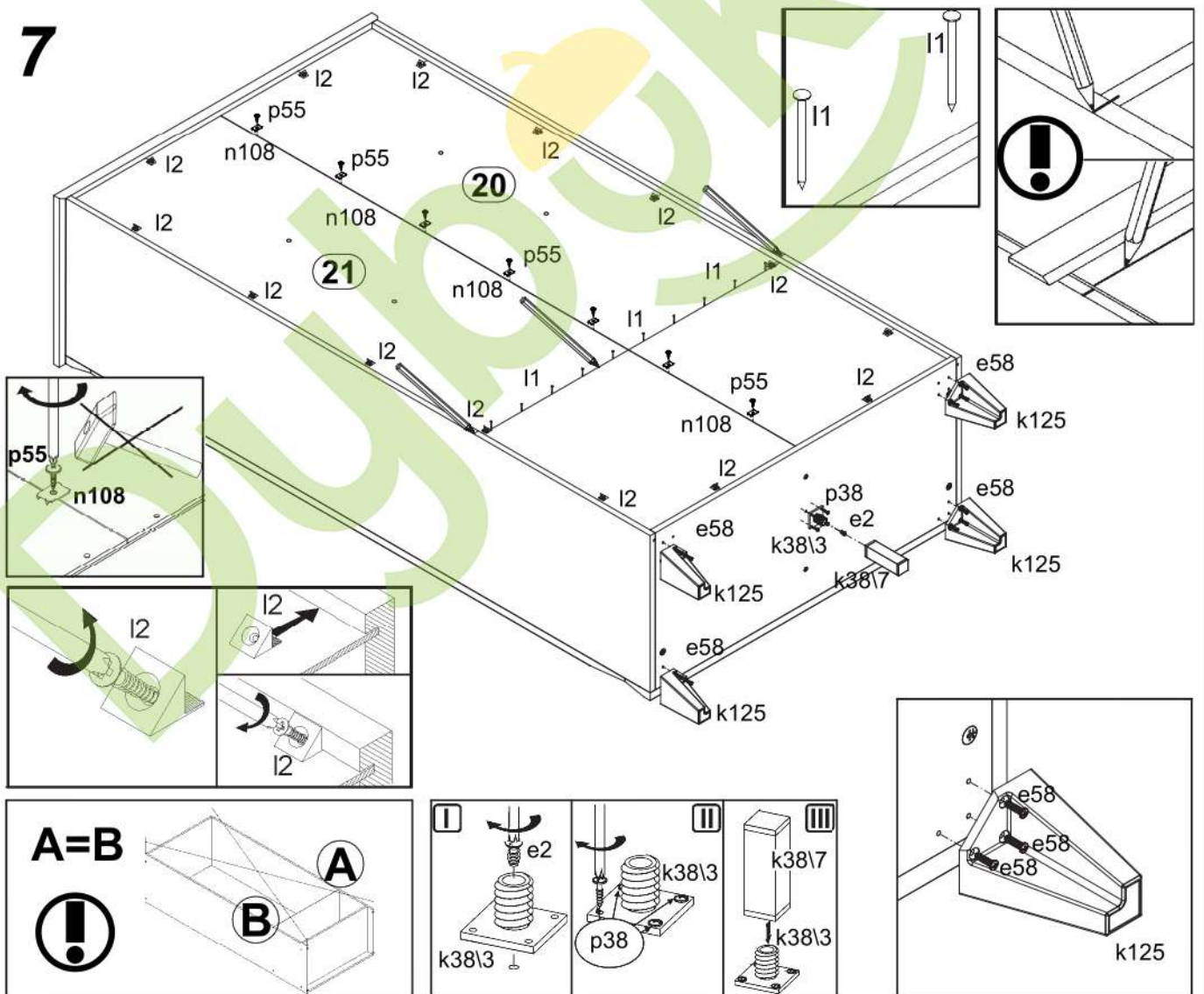

8 §11

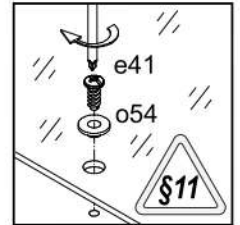
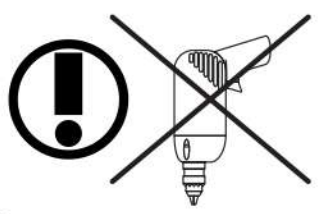

I

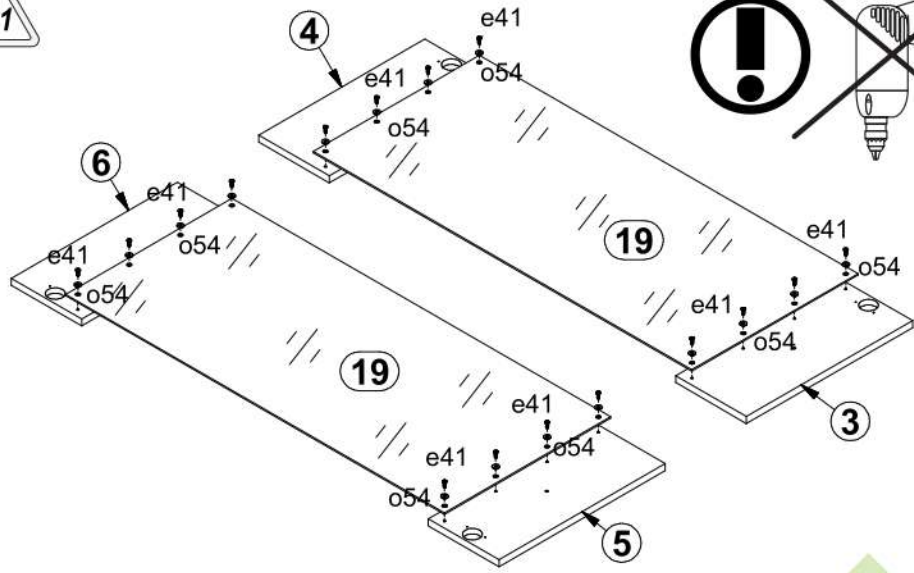

II

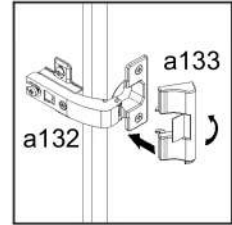
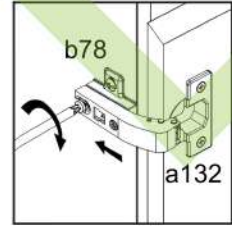
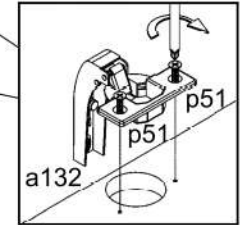
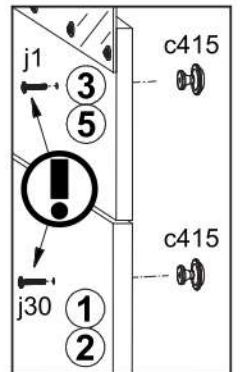
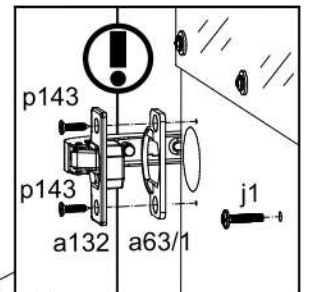
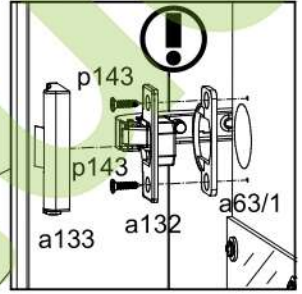
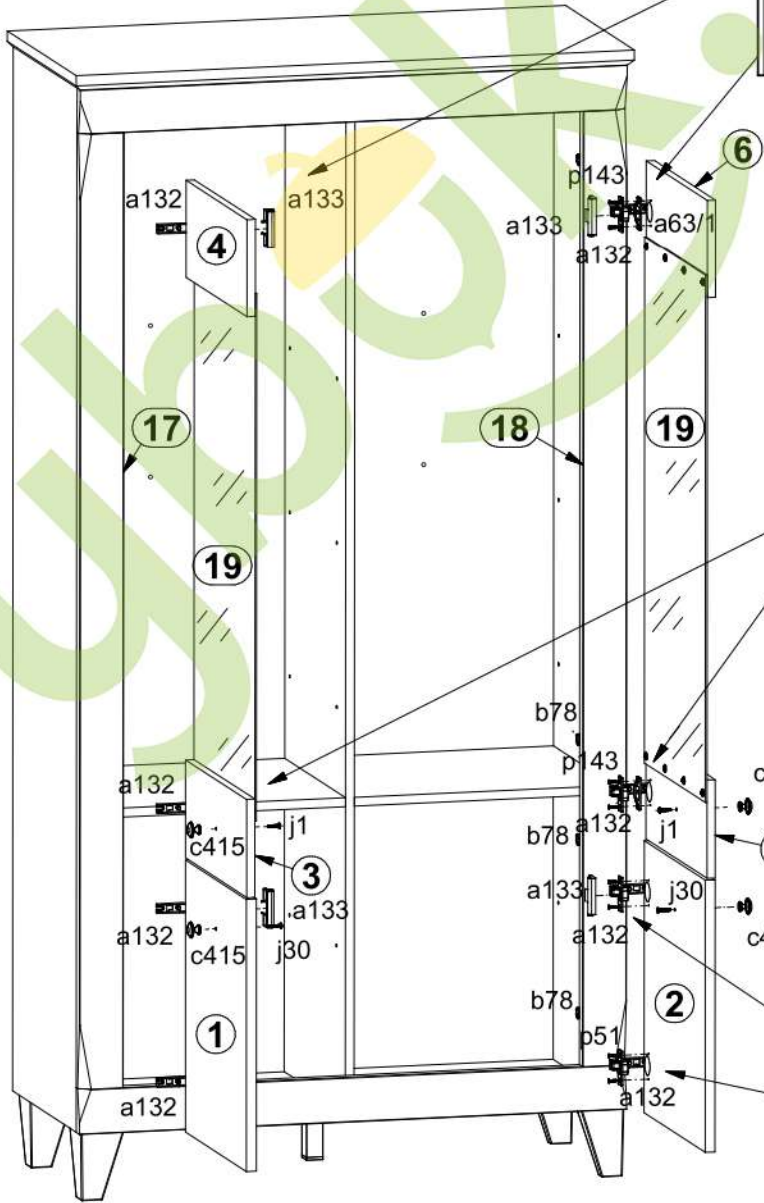

9

I

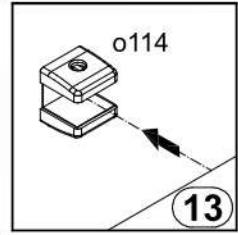
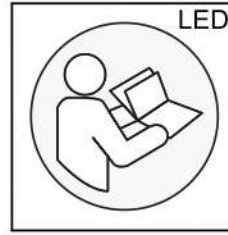
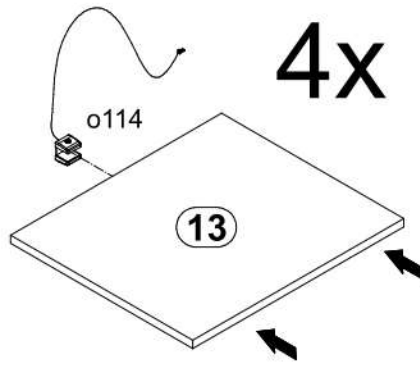

II

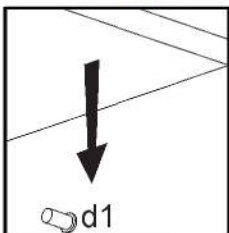
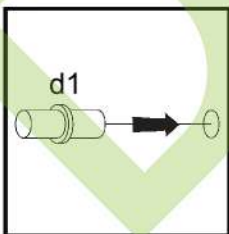
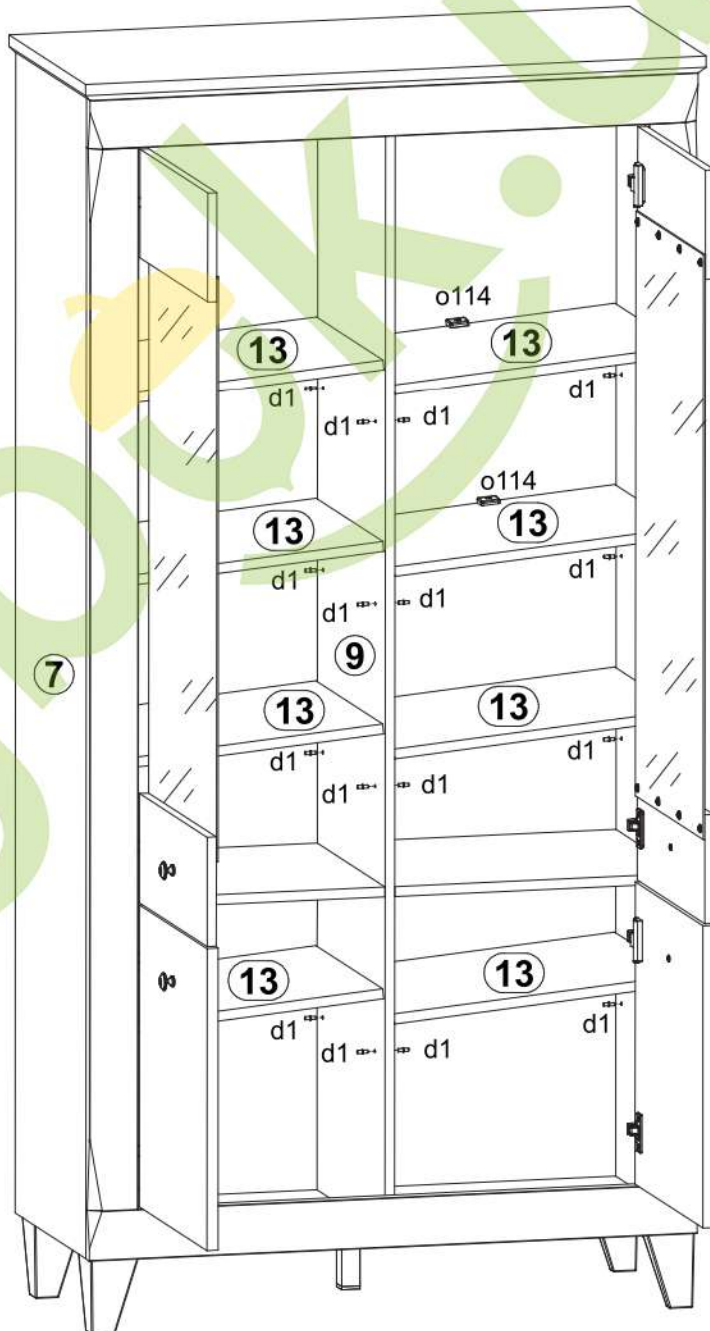

10

