

A	B	C	D	A	B	C	D		
1	S117-018	396	796	3/3	8	S117-314	375	410	2/3
2	S117-019	496	196	3/3	9	S117-513	400	120	3/3
3	S117-120	804	432	2/3	10	S117-514	400	120	3/3
4	S117-121	804	418	2/3	11	S117-516	444	106	2/3
5	S117-122	804	418	2/3	12	S117-927	454	406	3/3
6	S117-219	1300	450	1/3	13	S117-9903	814	389	2/3
7	S117-220	1300	450	1/3	14	S117-9904	814	499	2/3

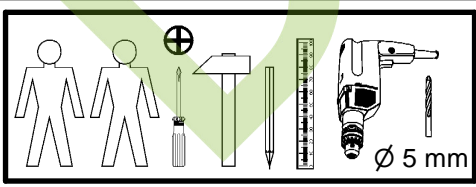

4x a44	4x b35	6x c306	16x d1 φ8x17 mm	32x e3 φ6x13 mm	16x f1 φ8x30 mm	16x f25 φ6.5x40 mm	12x j8 M4x25 mm	6x k43
35x l1	16x l2	12x o21 silikon	4x p25 φ3.5x16 mm	4x p35 φ3.5x10 mm	16x p38 φ3.5x16 mm	8x p51 φ3.5x15 mm	16x r1 φ1.5x12mm #16	16x r15 φ12x10.5mm #12
32x r42	8x s2 ø16	4x t33 400 mm	4x w78/L 400 mm	4x w78/P 400 mm	1x n26/1	1x p38 φ3.5x16 mm		

1 

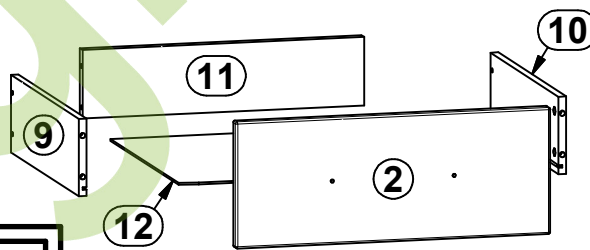
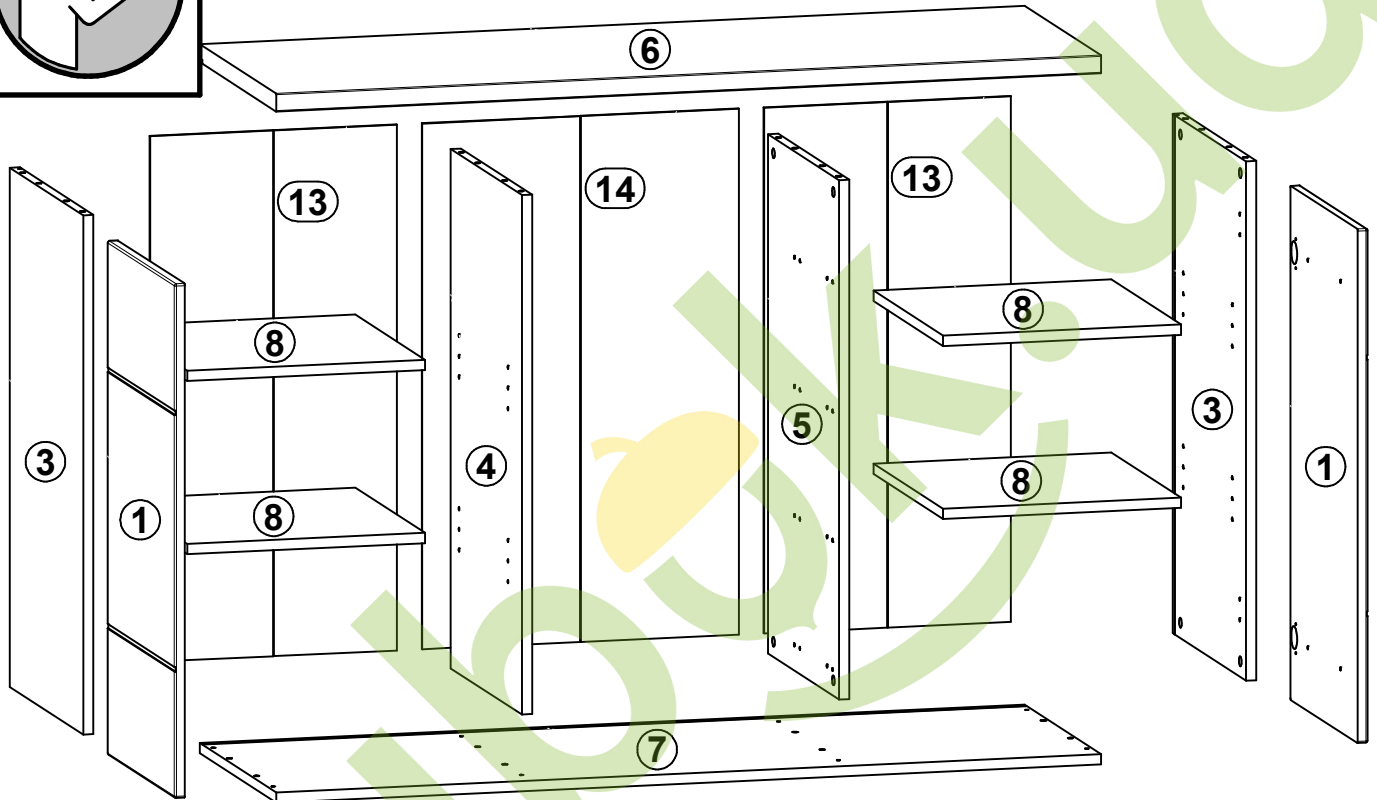
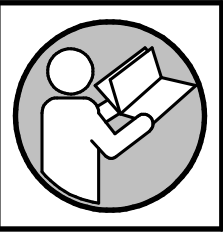
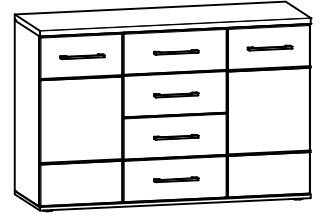
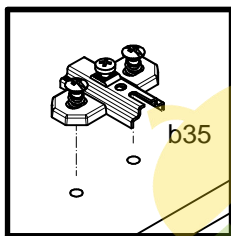
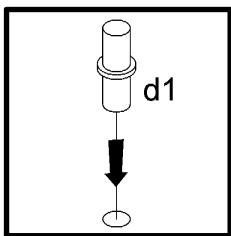
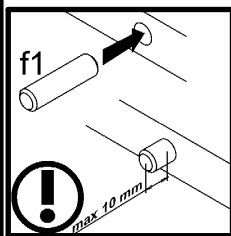
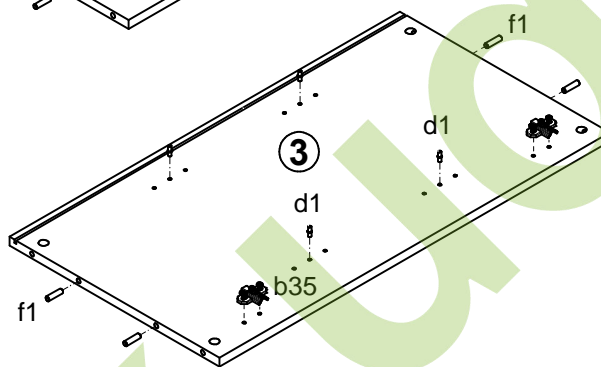
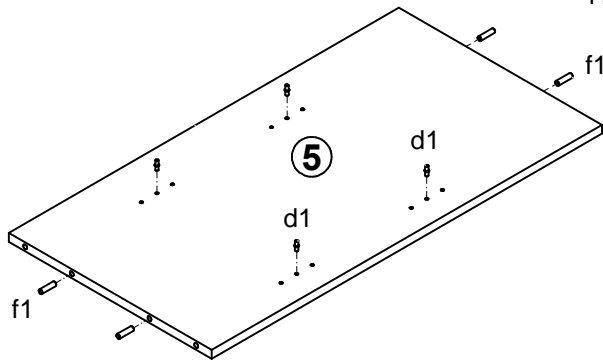
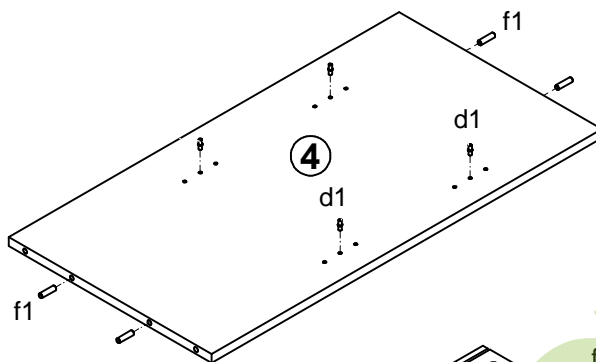
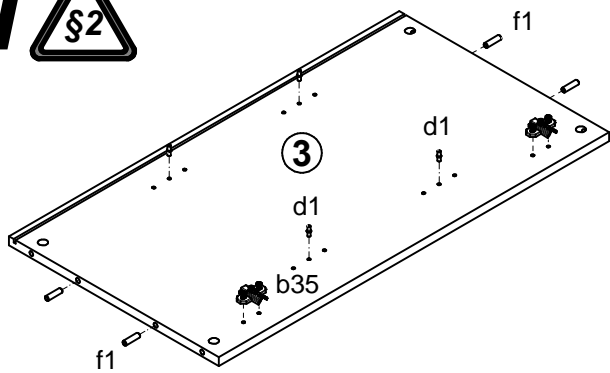

2 

