

A	B	C	D
1	S405-001	1919	496 3/3
2	S405-002	1919	496 3/3
3	S405-101	2050	540 2/3
4	S405-117	2050	540 2/3
5	S405-207	1029	590 1/3
6	S405-309	967	520 1/3
7	S405-411	1001	80 1/3
8	S405-556	1001	44 1/3
9	S405-410	967	200 1/3
10	S405-903	1983	490 2/3
11	S405-902	1983	490 2/3
12	DR-962	962	1/3
13	LH-1961	1961	14 2/3

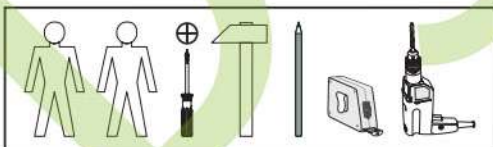

4x  a133	8x  a158	8x  b43	2x  c477/1	2x  c477/2	7x  d37	16x  e2 Ø6.3x13 mm
16x  f1 Ø8x30 mm	2x  j11 M4x28 mm	4x  k1	20x  l1	16x  l2	2x  n1	1x  n26/1
2x  p1 Ø3.5x13 mm	35x  p38 Ø3.5x16 mm	16x  p51 Ø3.5x15 mm	22x  r1 Ø15x12 mm #16	22x  r16 20/9	18x  s2 Ø16	

# 1

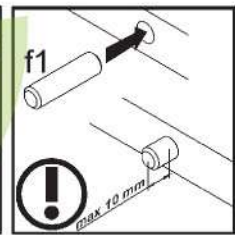
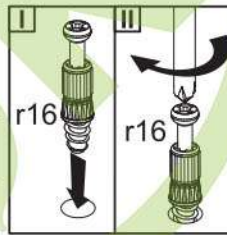
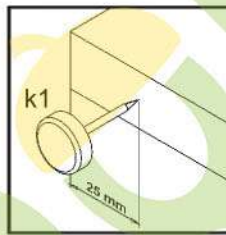
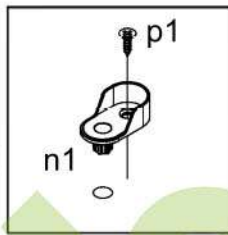
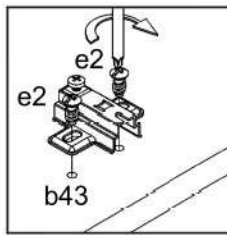
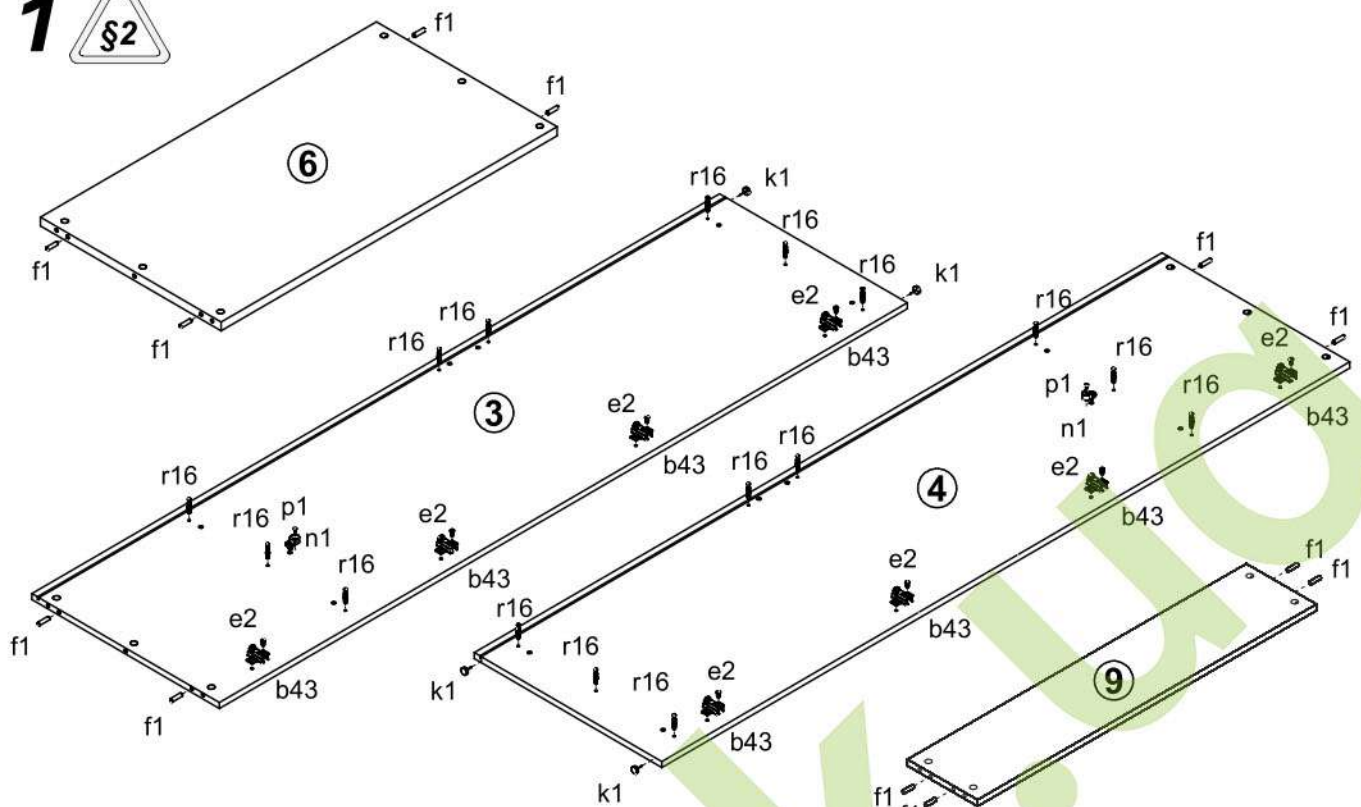

# 2

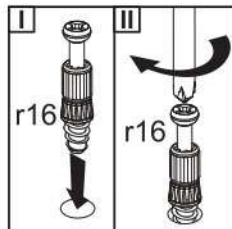
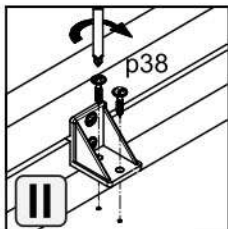
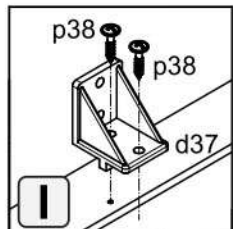
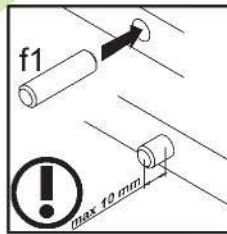
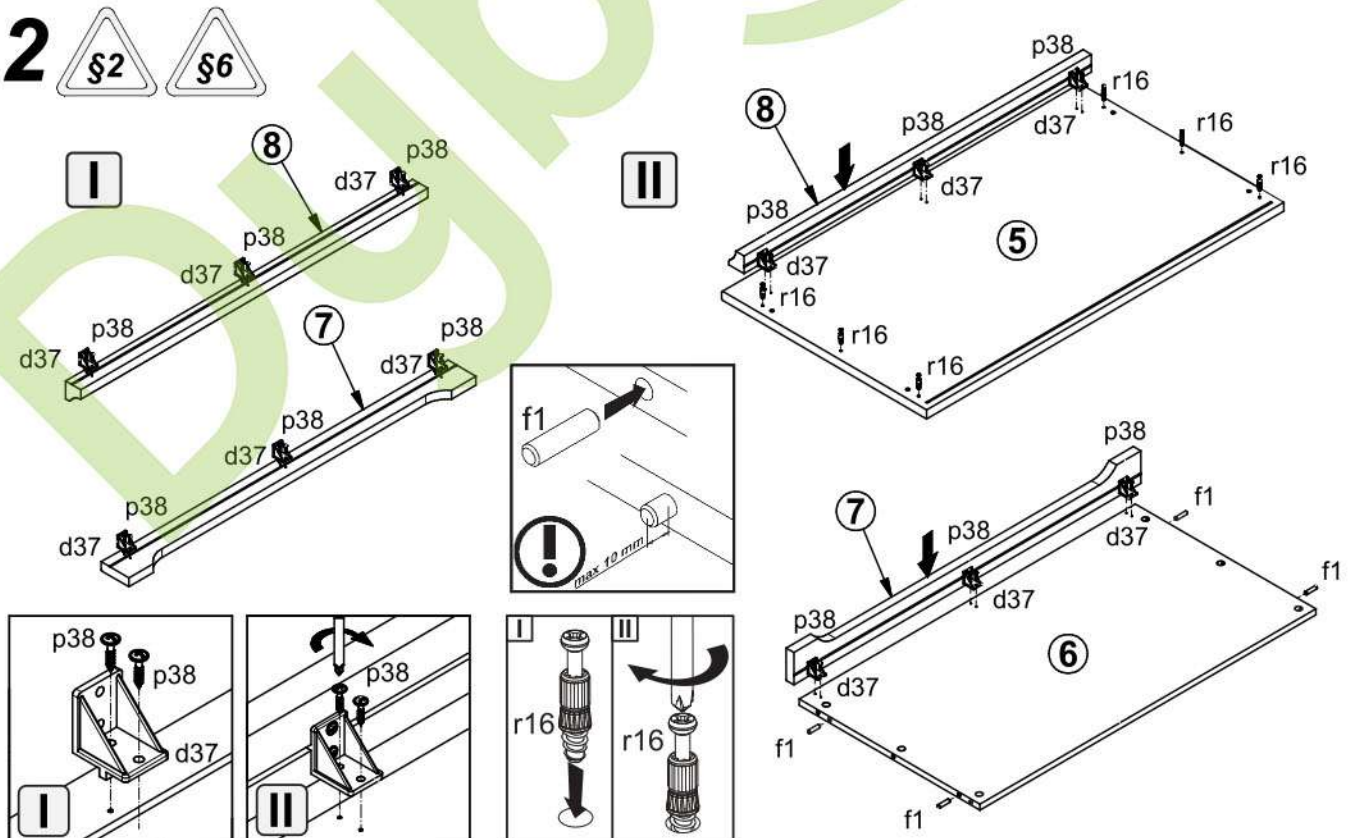

# 3

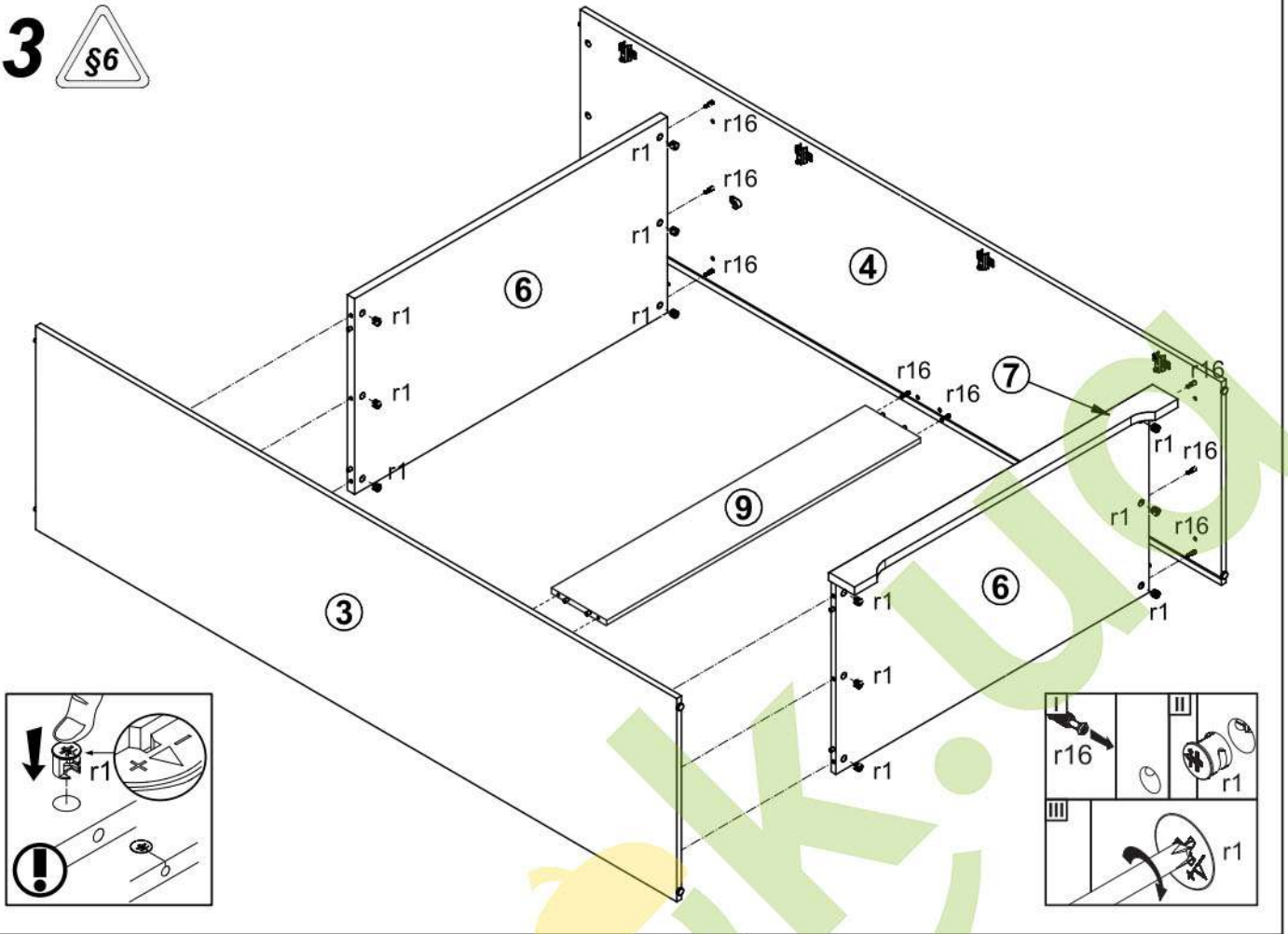

# 4

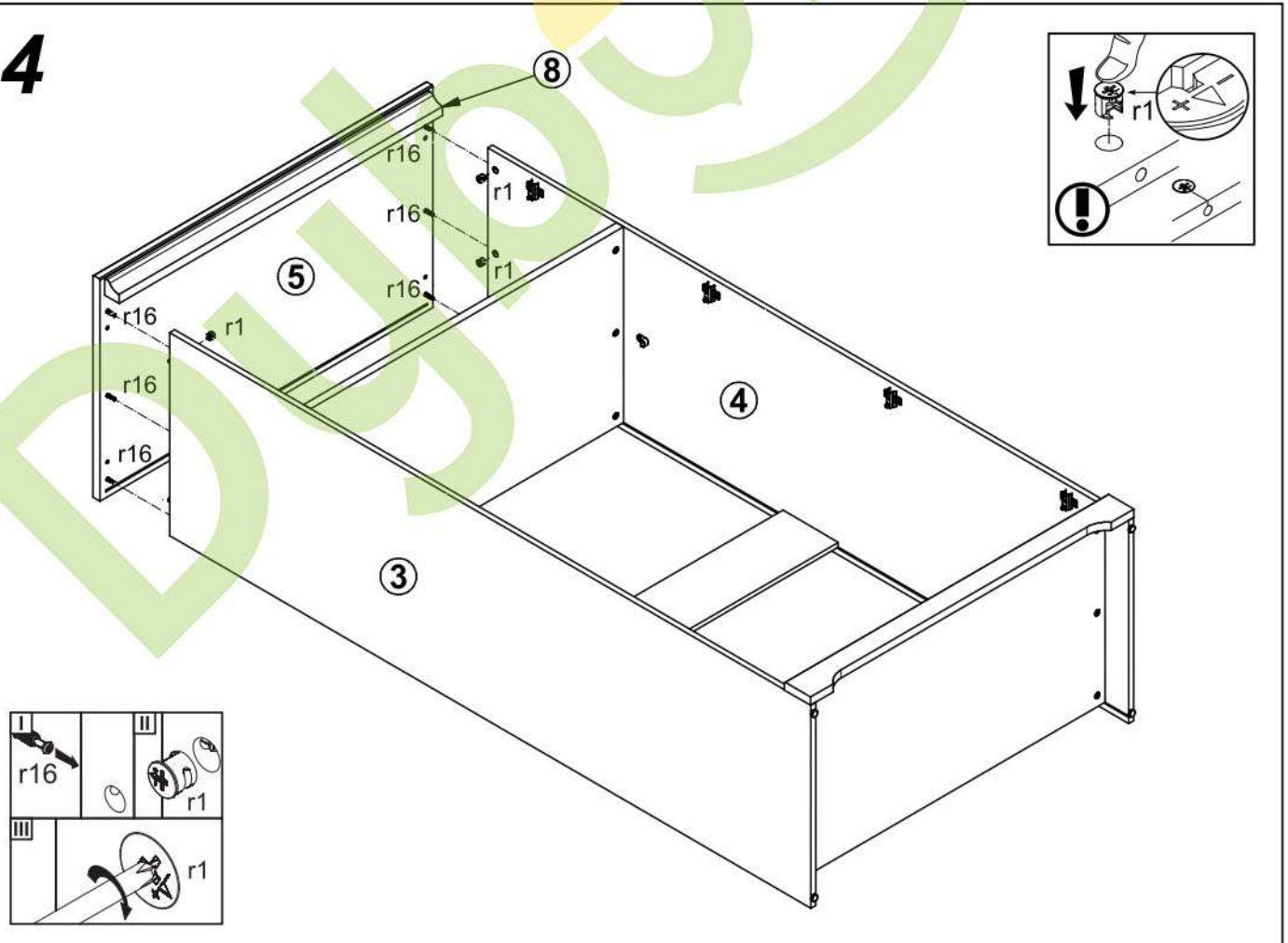
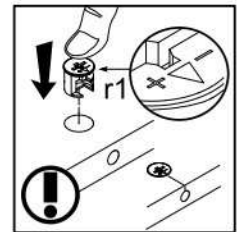

# 5

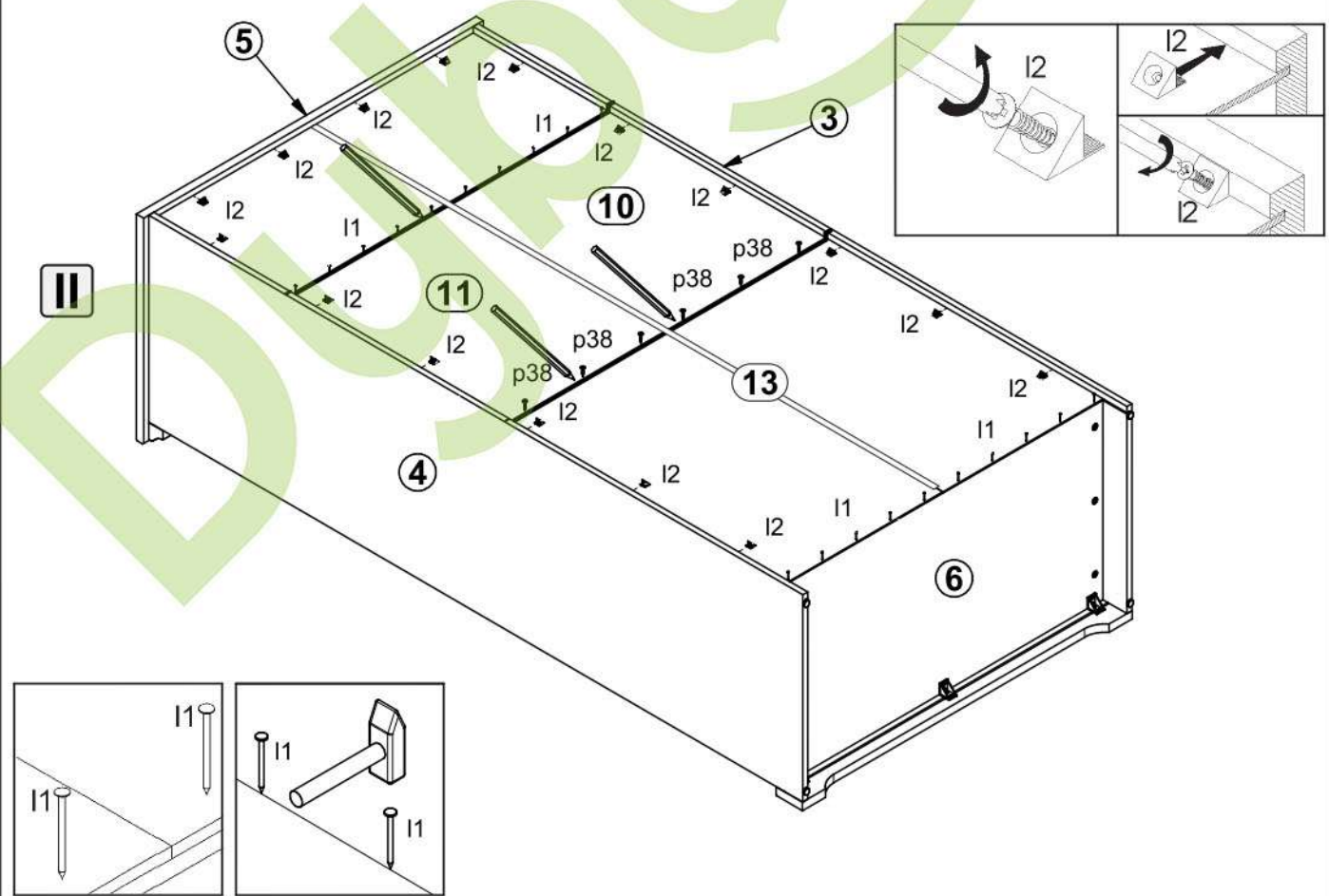
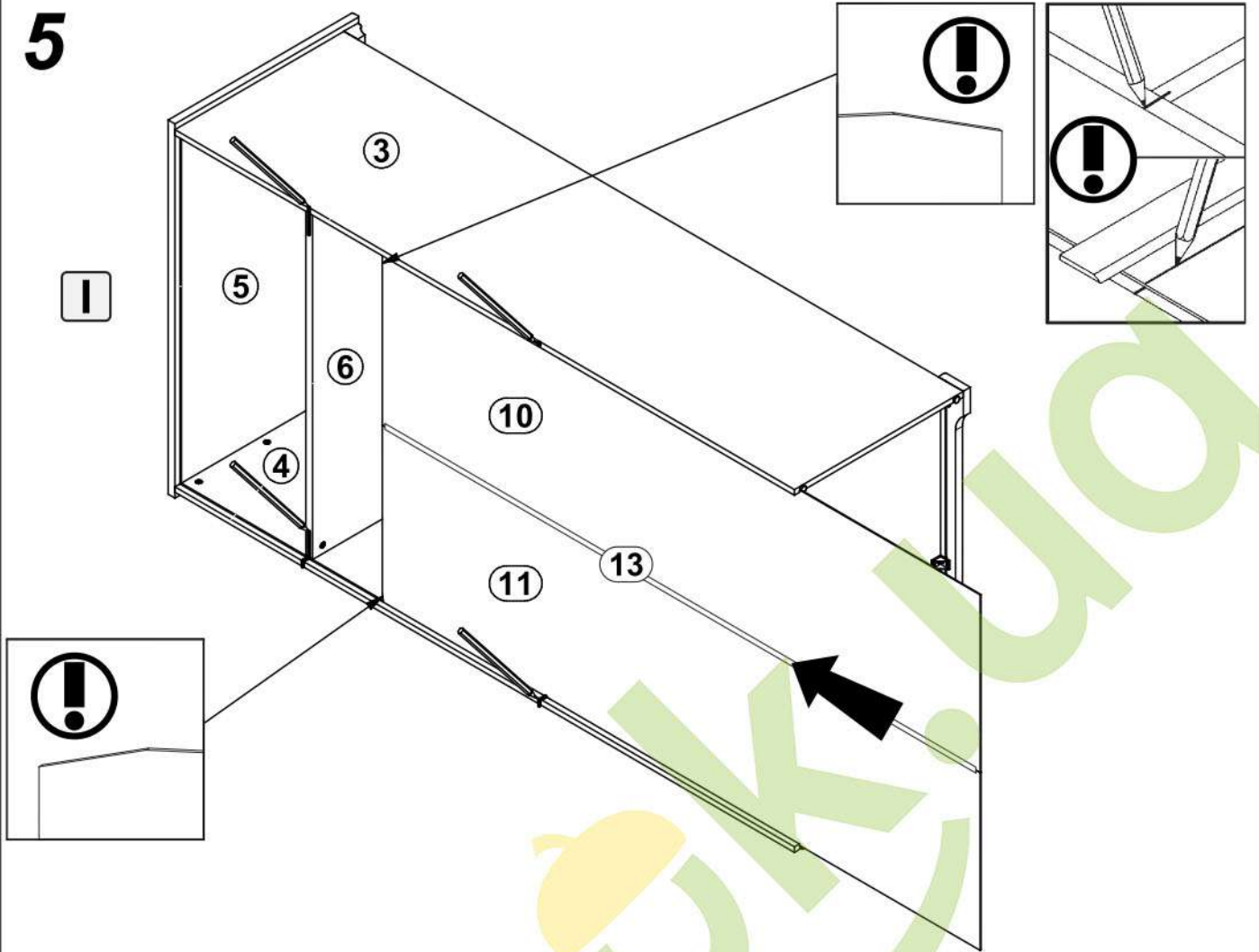

6

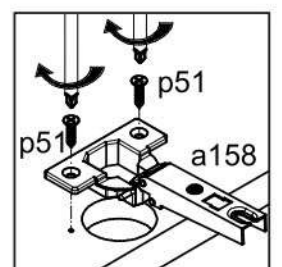
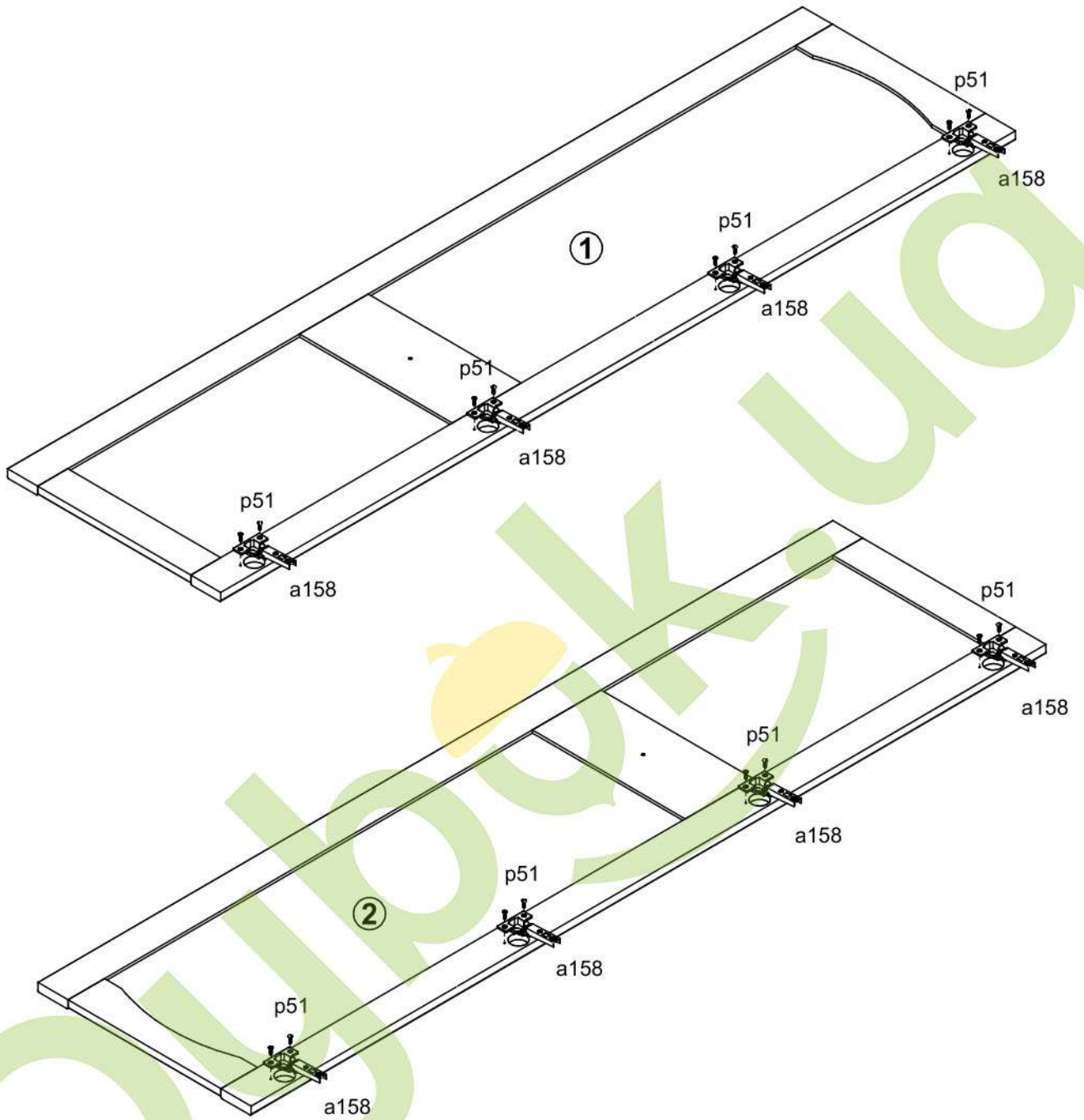

# 7

