

A	B	C	D	A	B	C	D	A	B	C	D			
1	S239-0003	2190	480	5/6	7	S239-2004	1212	581	2/6	14	LH-2211	2211	14	3/6
1	S239-0003	2190	480	6/6	8	S239-2003	1212	581	2/6	15	S239-9003	2245	482	3/6
2	S239-0004	2190	480	6/6	9	S239-2009	1212	595	2/6	16	S239-4001	946	160	1/6
3	S239-1003	2196	552	4/6	10	S239-2010	1212	595	2/6	17	DR-941	941		1/6
4	S239-1004	2196	552	4/6	11	S239-3001	946	552	1/6					
5	S239-1005	2196	552	3/6	12	S239-3002	466	552	1/6					
6	S239-1006	2196	552	3/6	13	S239-3003	466	522	1/6					

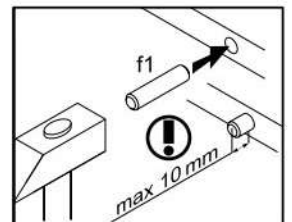

4x a44	6x a68	4x a102	6x a103	4x b19	6x b35	10x b59	5x c415
12x d1	4x d4	32x f1	4x f6	5x j11	10x k43	190x l1	4x n1
2x n2611	4x p1	14x p38	40x p51	62x r1	6x r3	6x r10	56x r16
48x s2							

1 

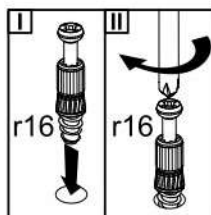
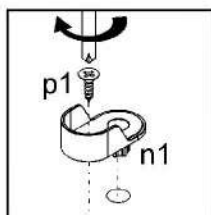
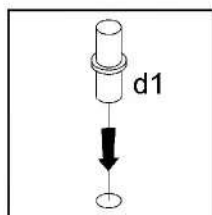
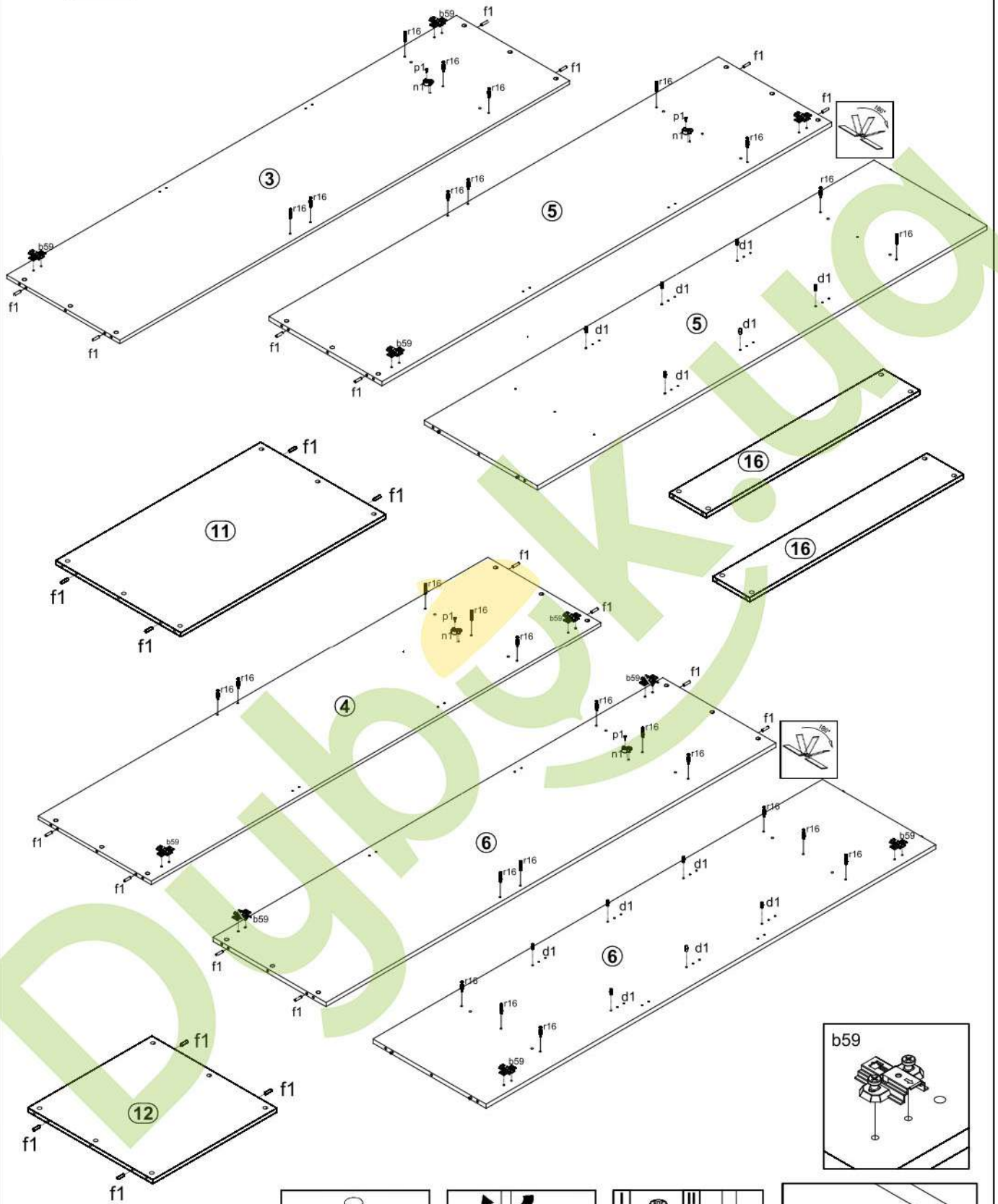

2

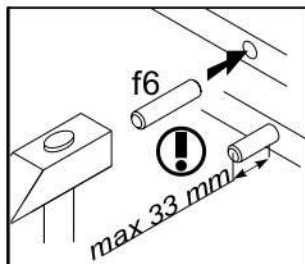
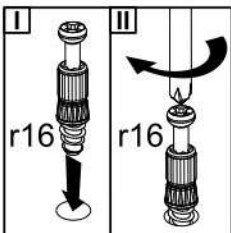
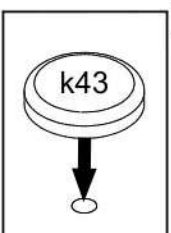
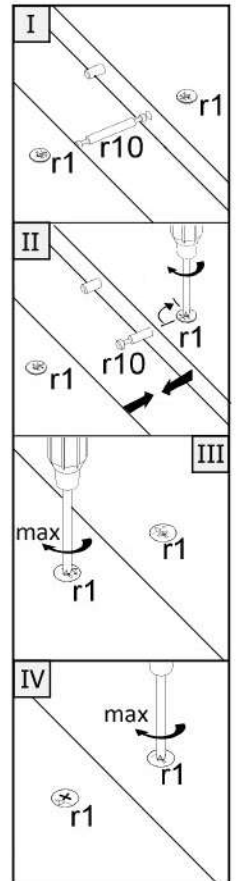
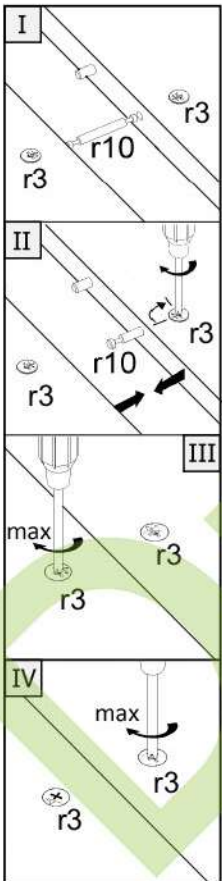
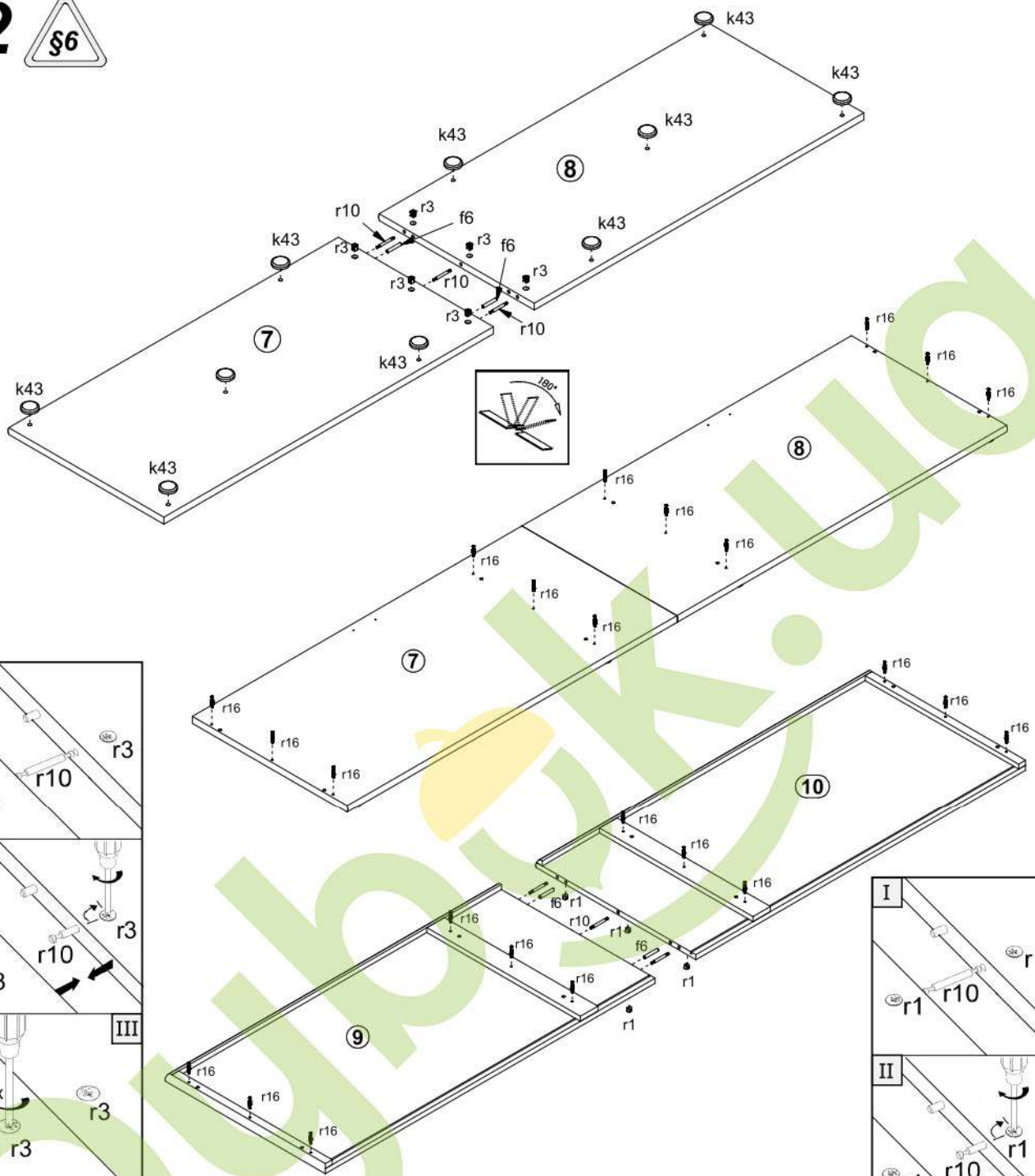

3

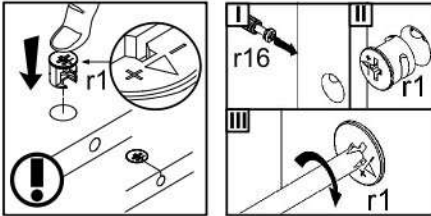
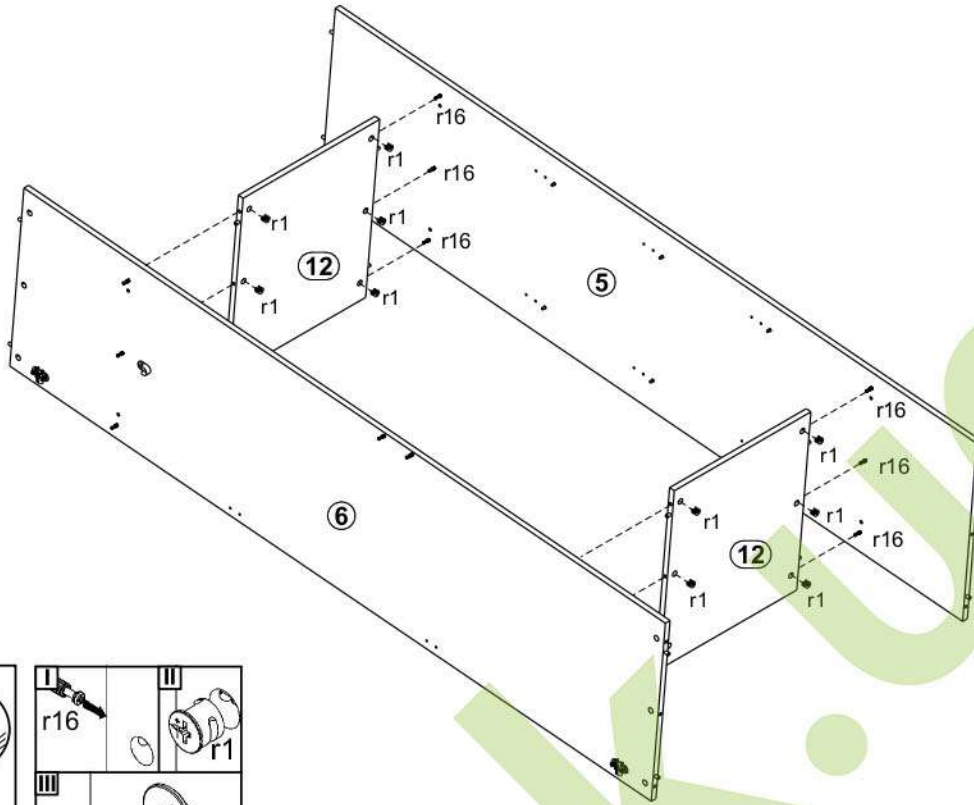

4

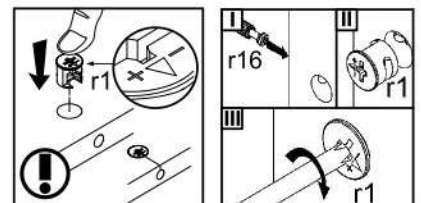
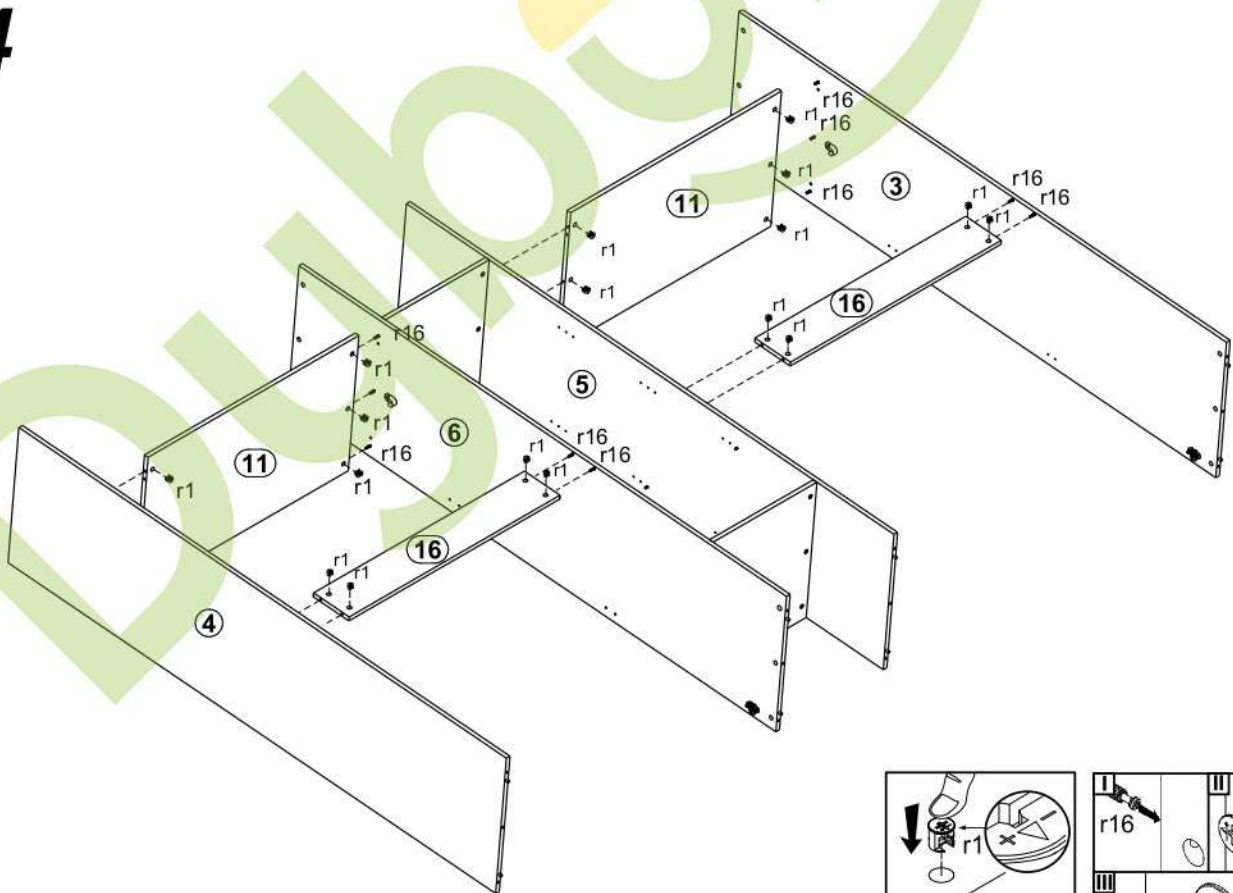

5

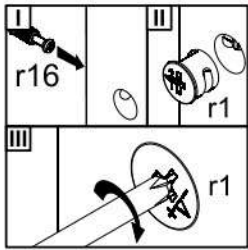
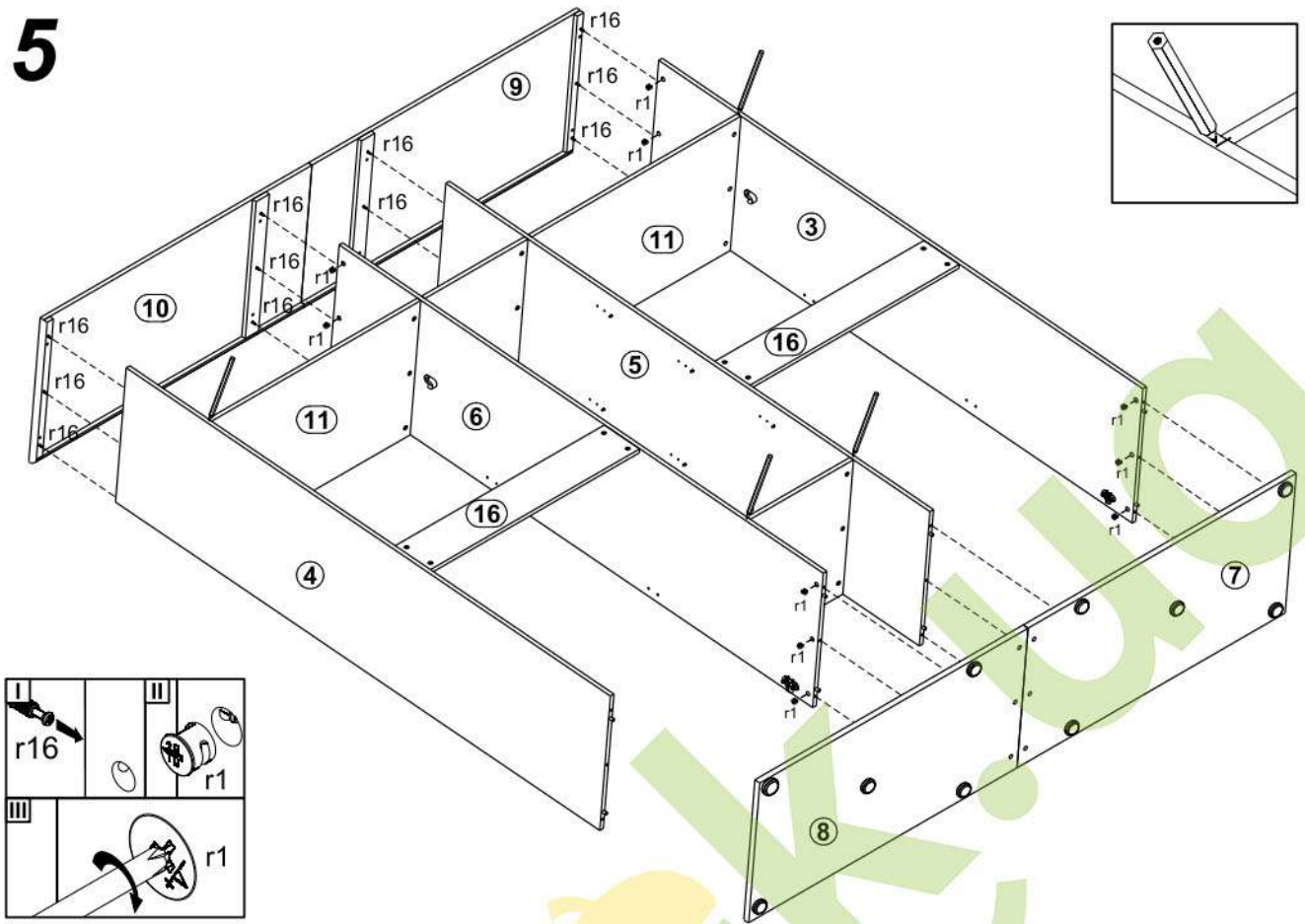

6

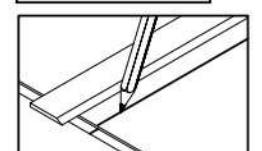
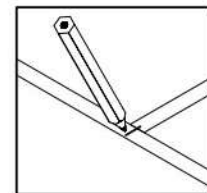
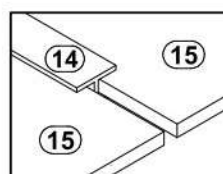
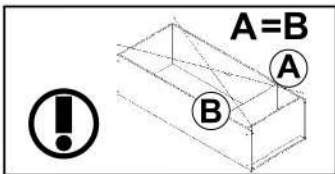
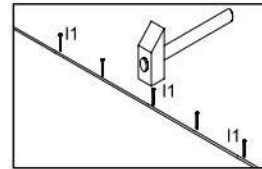
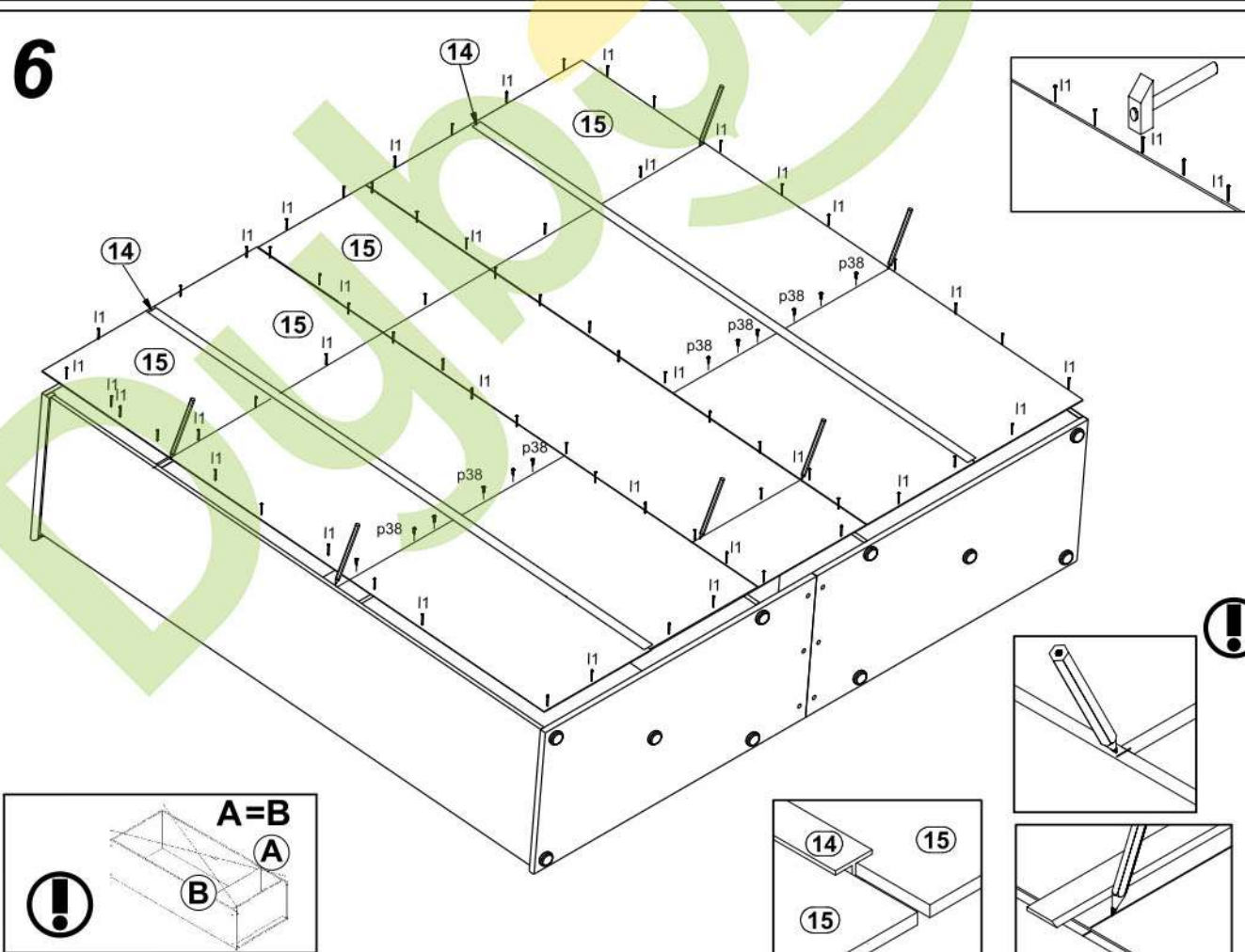

7

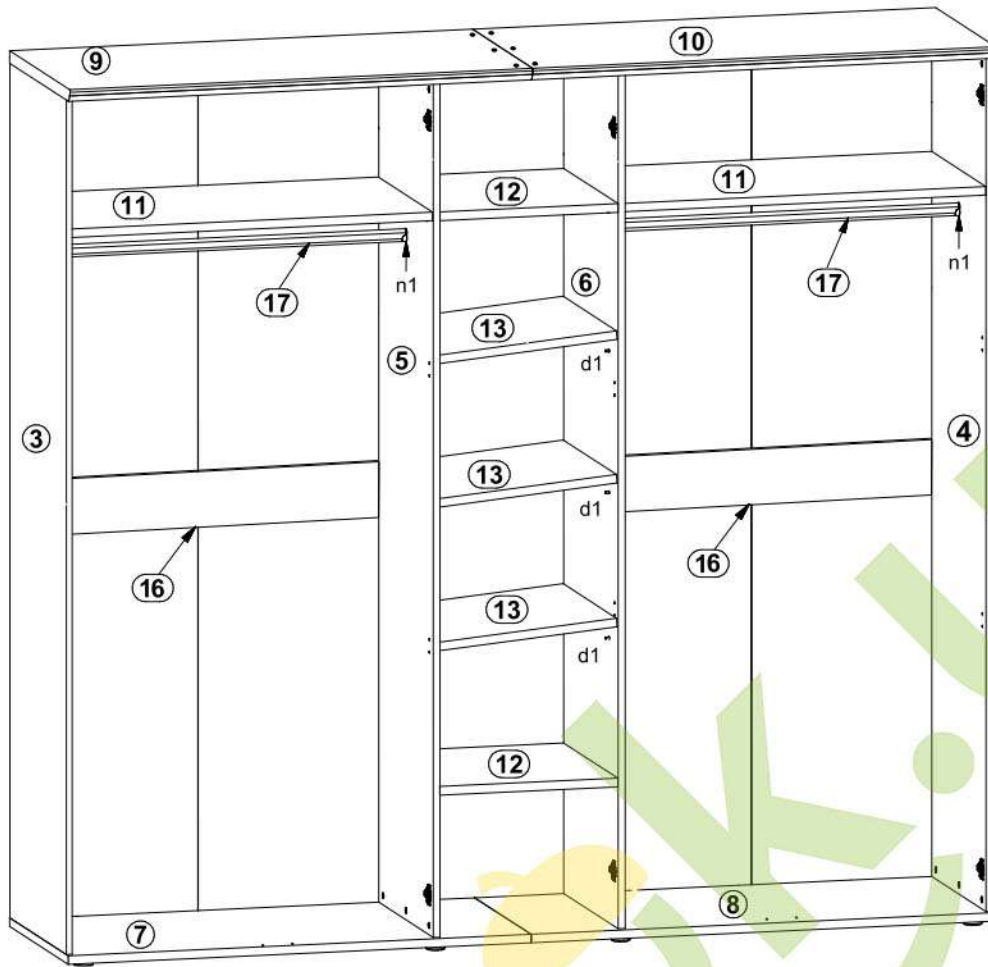

8

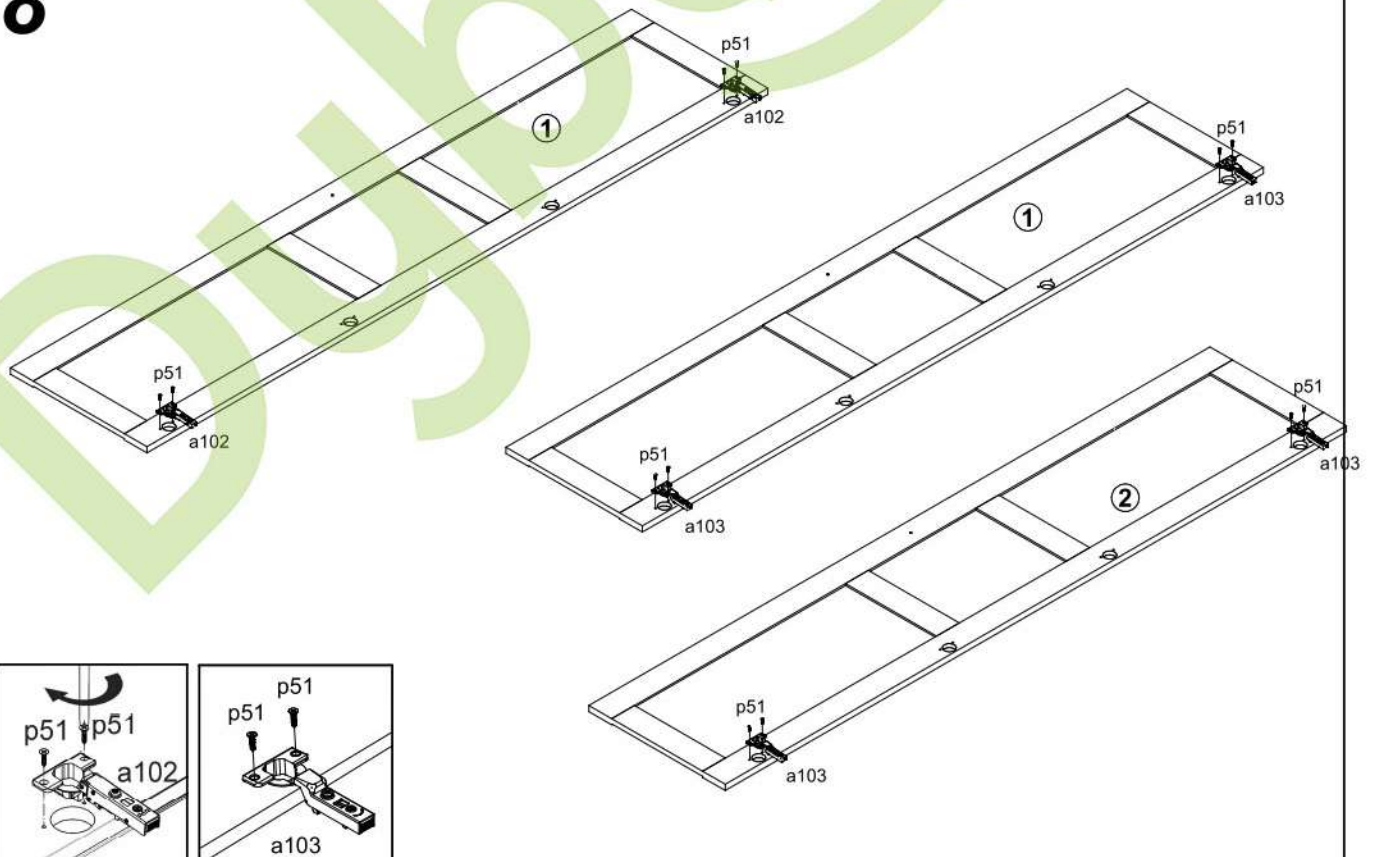

9

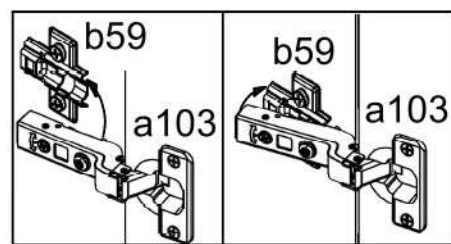
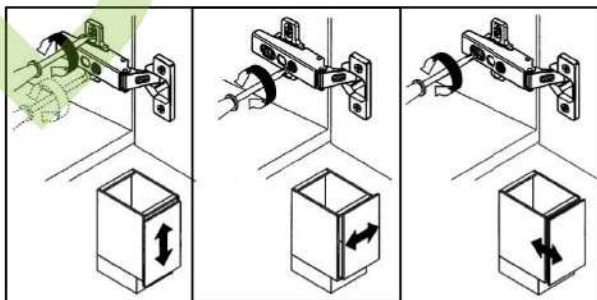
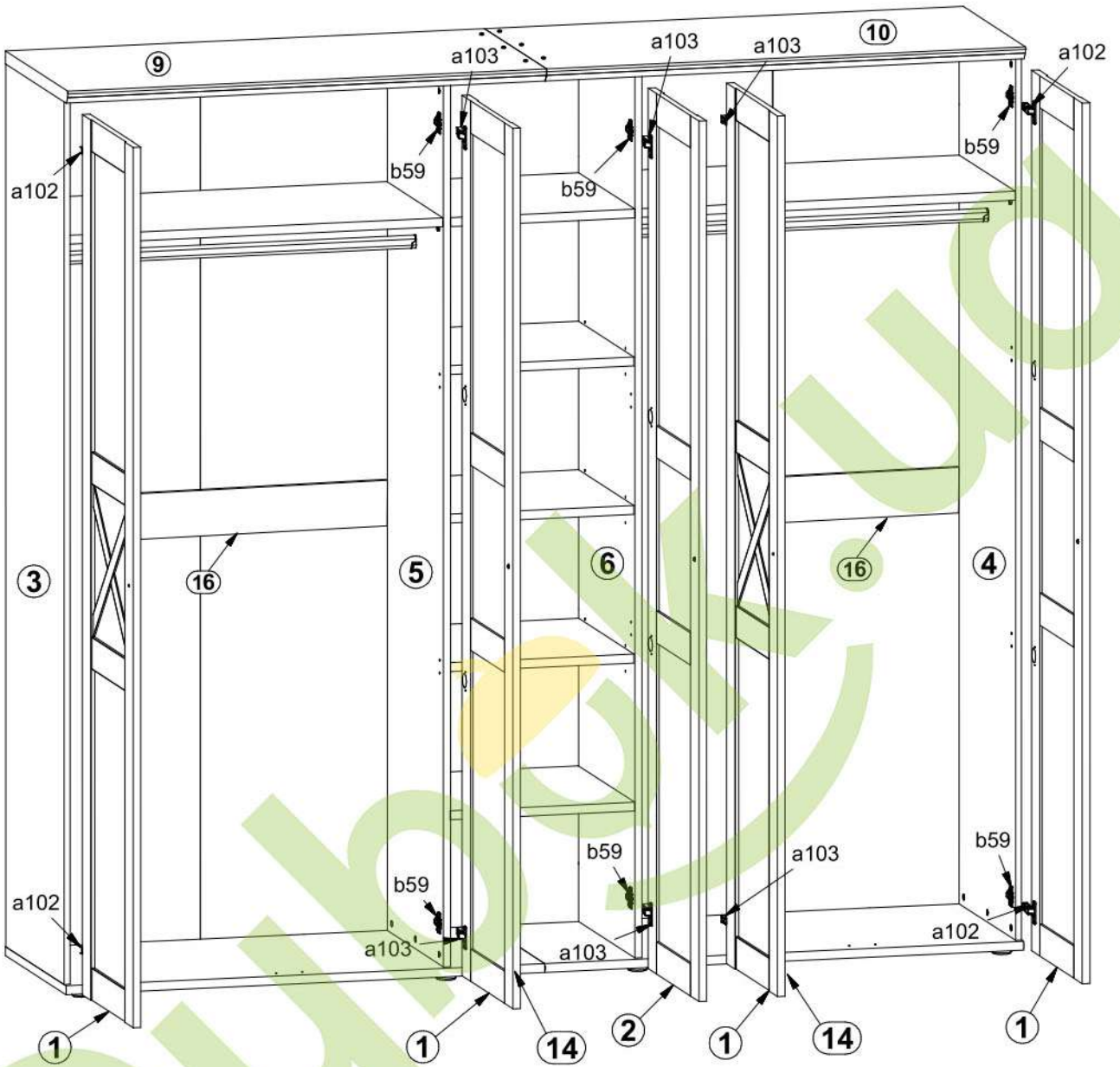

10

