

S320-SZFN5D

A	B	C	D	A	B	C	D		
1	S320-170	2077	370	1/7	19	S320-176	324	370	2/7
2	S320-171	2077	370	1/7	20	S320-940	2103	548	7/7
3	S320-172	2077	370	1/7	21	S320-941	2103	407	7/7
4	S320-173	2077	370	1/7	22	S320-942	2103	379	7/7
5	S320-174	1737	370	1/7	23	S320-595	599	80	4/7
6	S320-258	549	392	3/7	24	S320-596	599	80	4/7
7	S320-259	549	392	3/7	25	S320-597	555	80	4/7
8	S320-260	770	770	3/7	26	S320-509	433	80	4/7
9	S320-261	549	392	3/7	27	S320-511	433	80	4/7
10	S320-262	549	392	3/7	28	S320-575	80	38	3/7
11	S320-263	770	770	3/7	29	S320-513	408	210	5/7
12	S320-339	754	754	3/7	30	S320-514	408	210	5/7
13	S320-340	527	370	2/7	31	S320-548	358	243	5/7
14	S320-342	527	370	2/7	32	S320-0033	1686	540	6/7
15	S320-343	291	370	2/7	33	S320-0035	380	540	6/7
16	S320-341	526	369	2/7	34	S320-0049	384	540	6/7
17	S320-344	290	369	2/7	35	S320-0050	1686	540	6/7
18	S320-175	1737	370	2/7	36	dr-423	423	22	2/7
					37	Lh-2071	2071	14	7/7

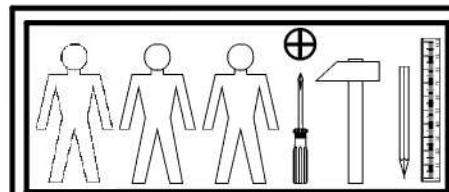

4x a49	10x a44	4x b22	10x b19	5x c35/1	5x c35/2	28x d1	2x n1	2x p1
7x e8	52x f1	11x f6	5x j6	48x r42	10x r10	60x r1	4x p27	28x p51
8x r3	5x s1	66x s2	230x l1	20x e2	8x e26	1x z1	11x p38	8x p46
1x n26/1	1шт. f35	1шт. p17	1x d4	2x n48	2x n40	1x m22	10x p8	

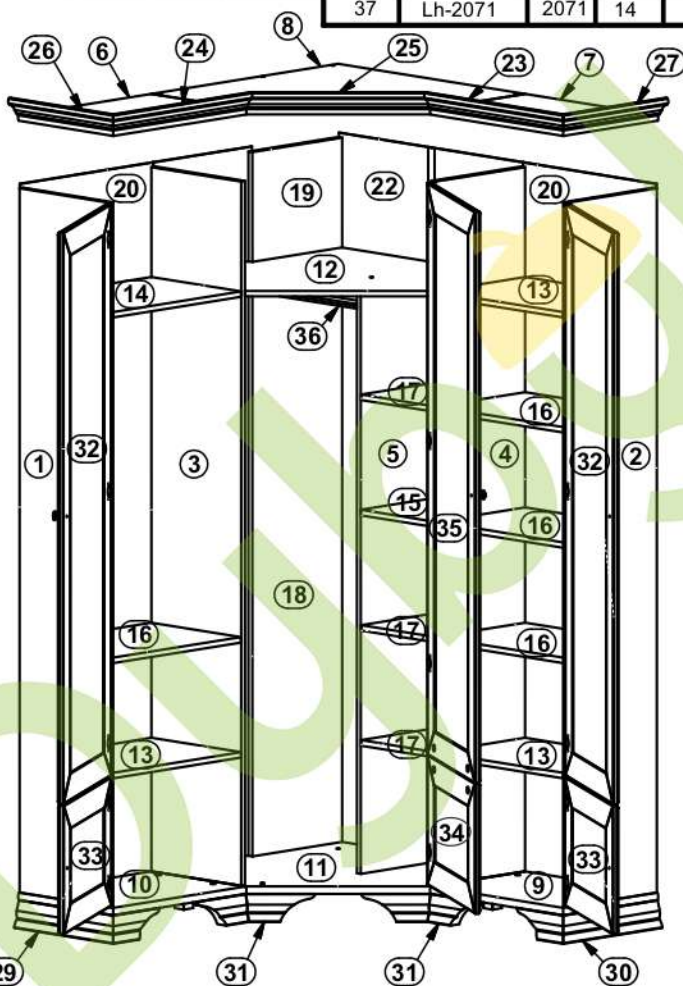
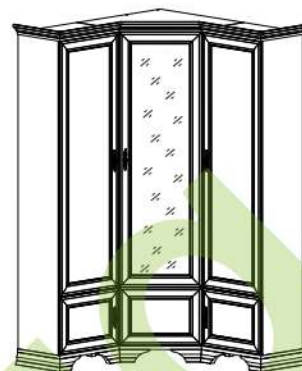
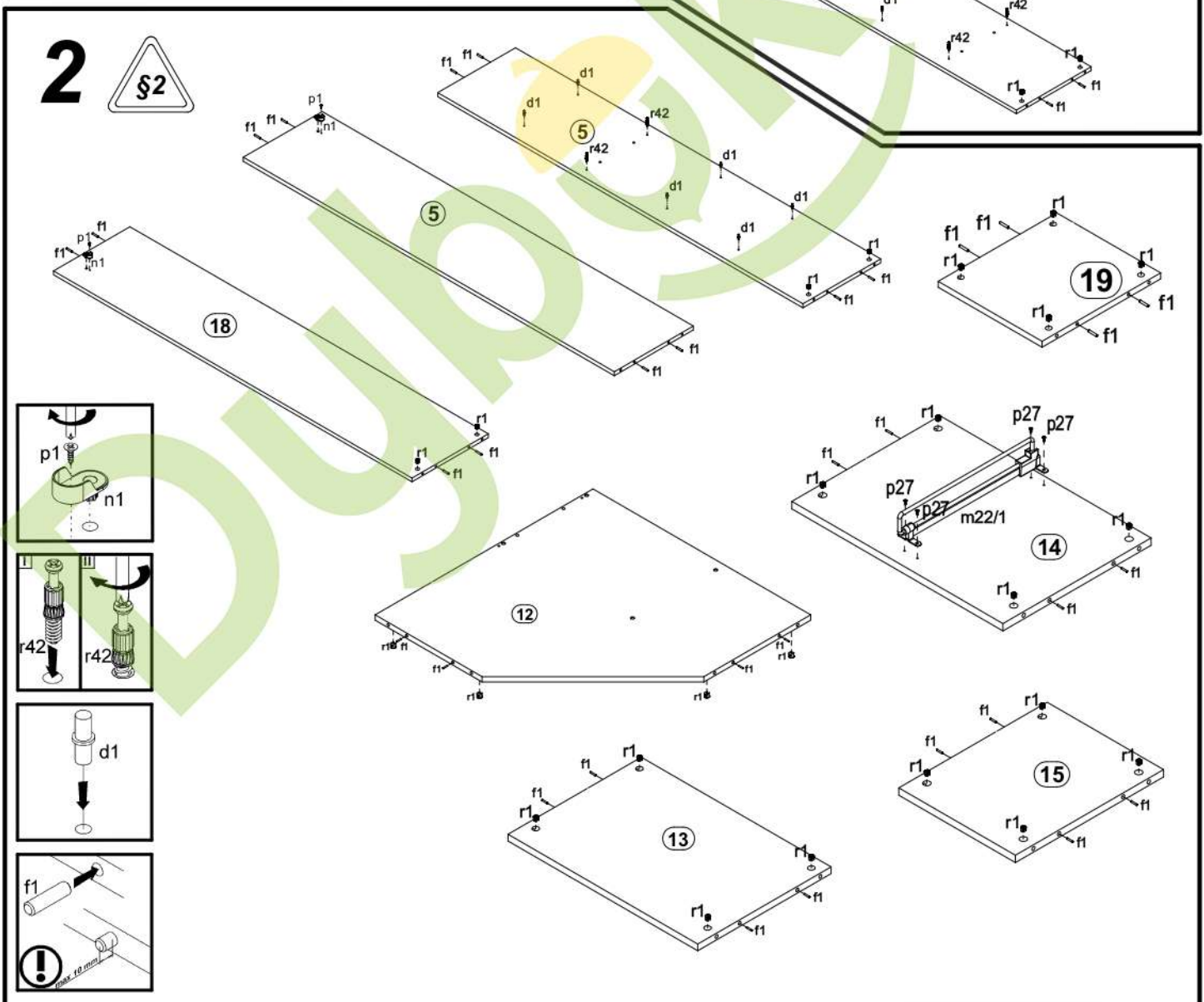
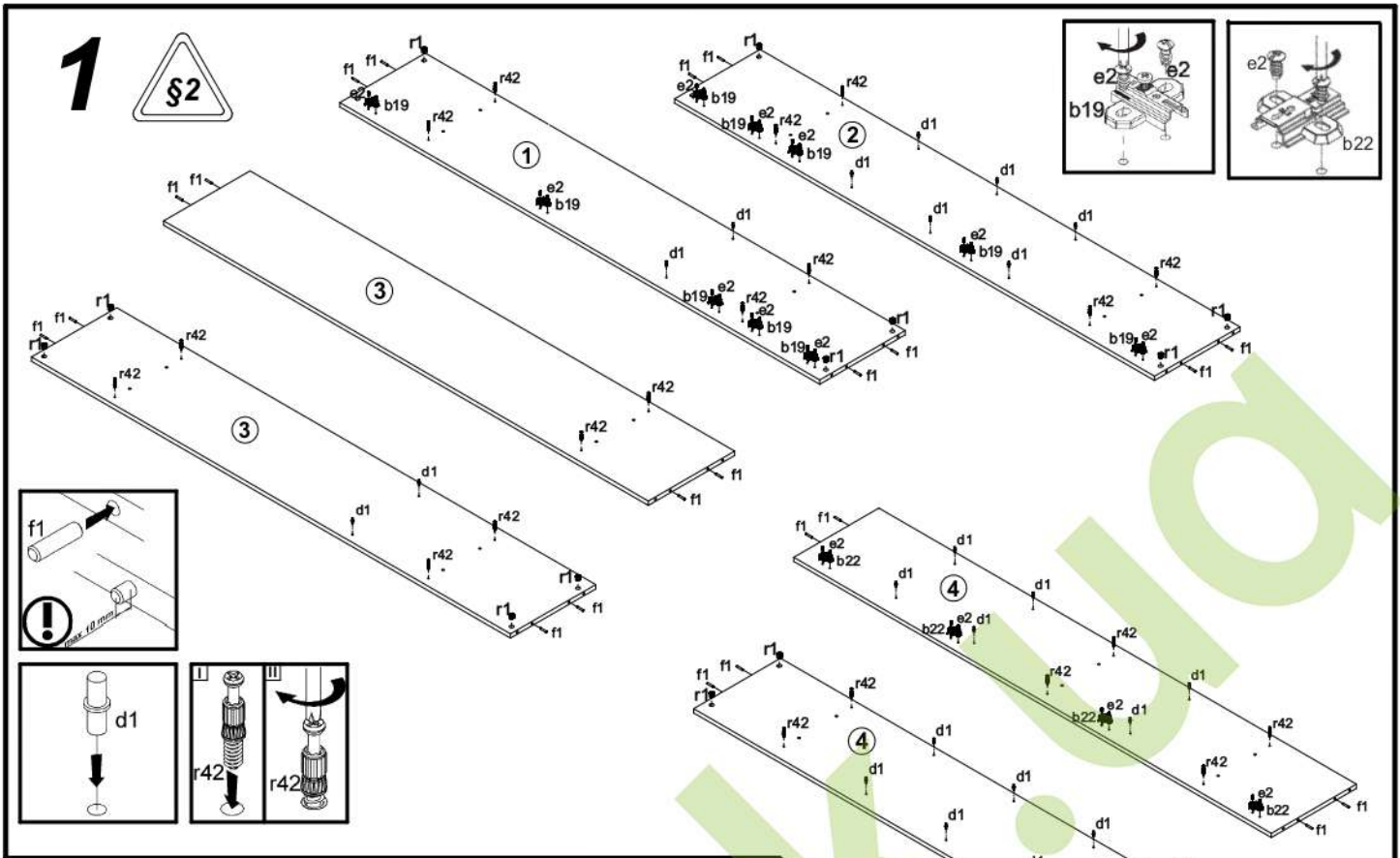

3

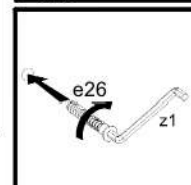
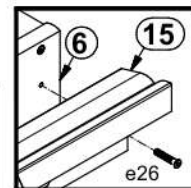
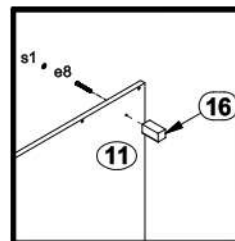
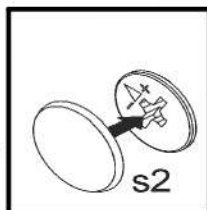
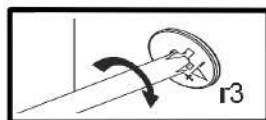
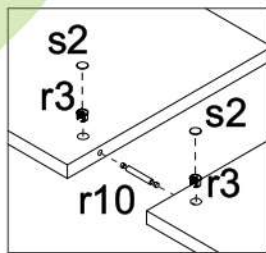
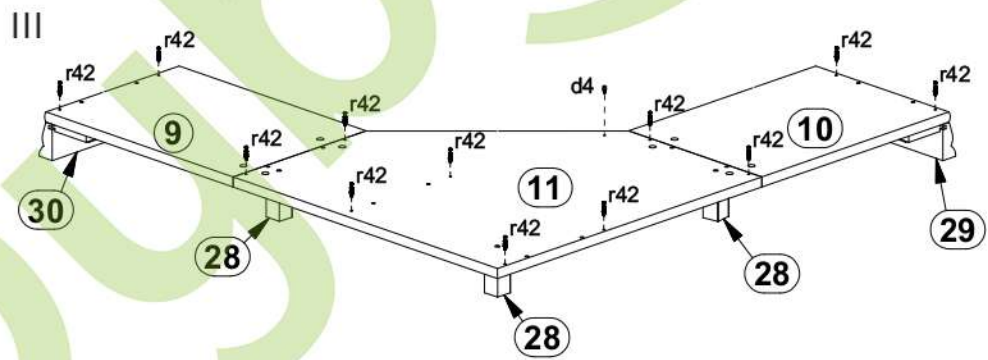
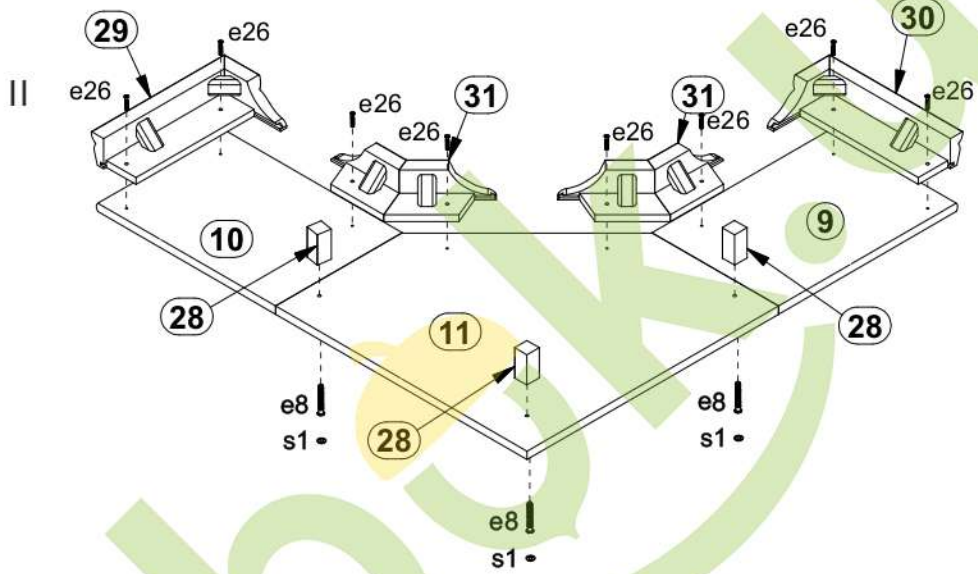
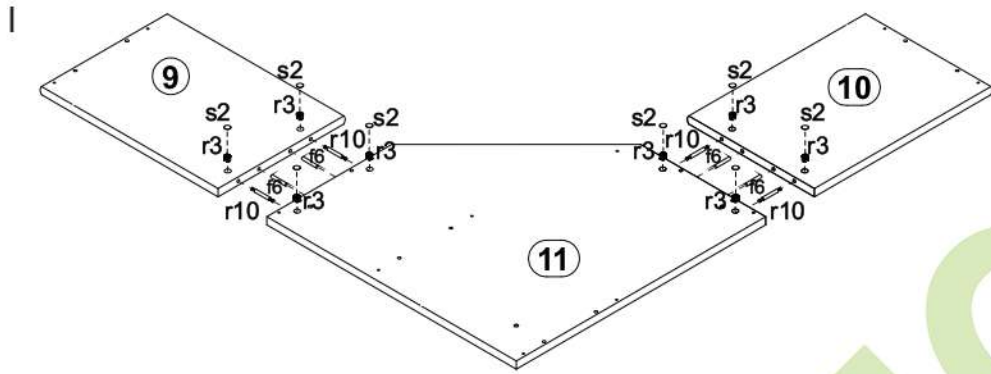

4

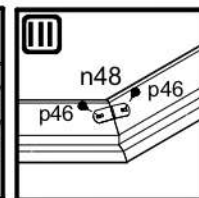
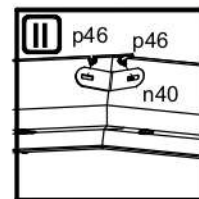
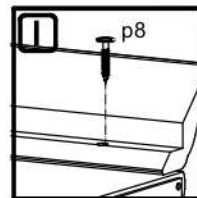
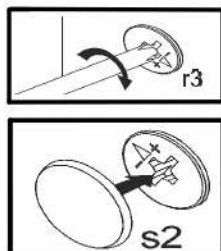
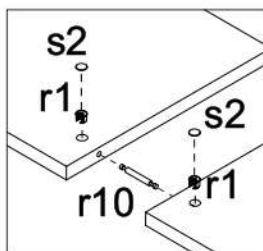
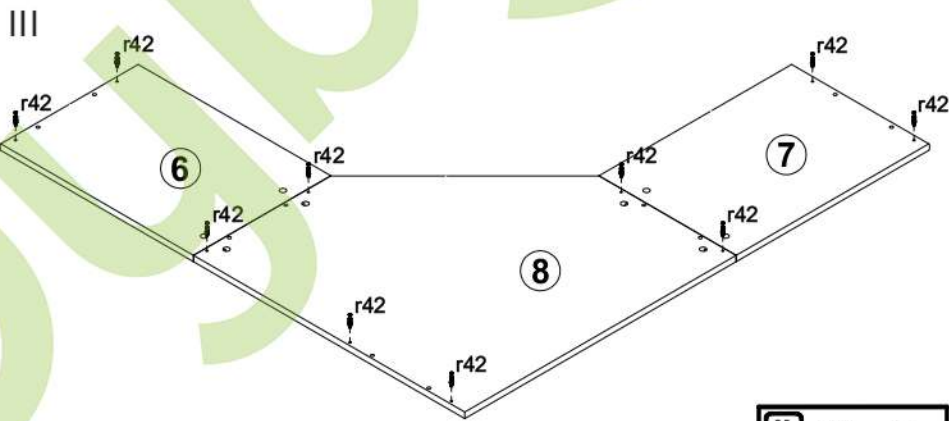
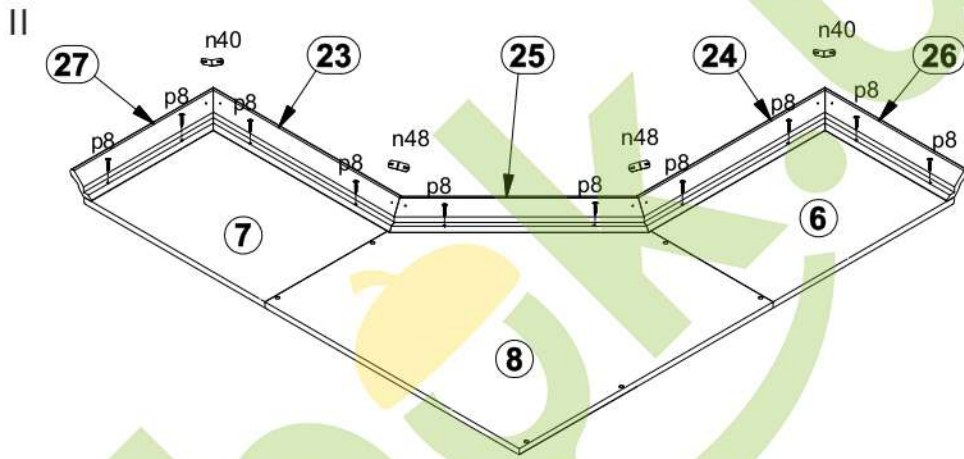
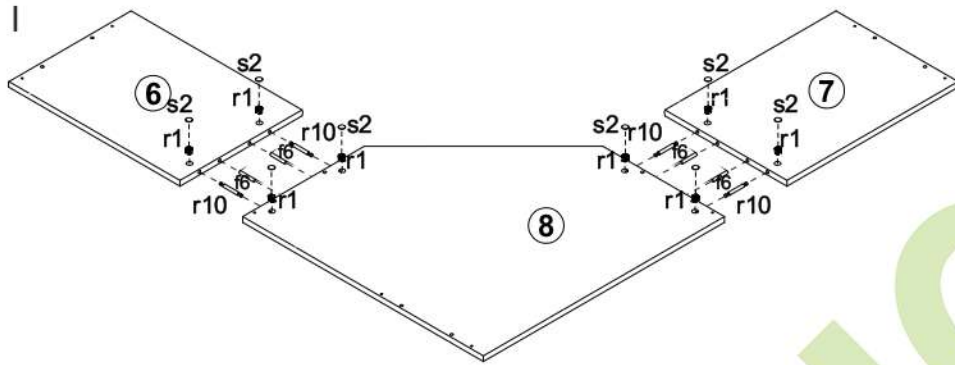

5

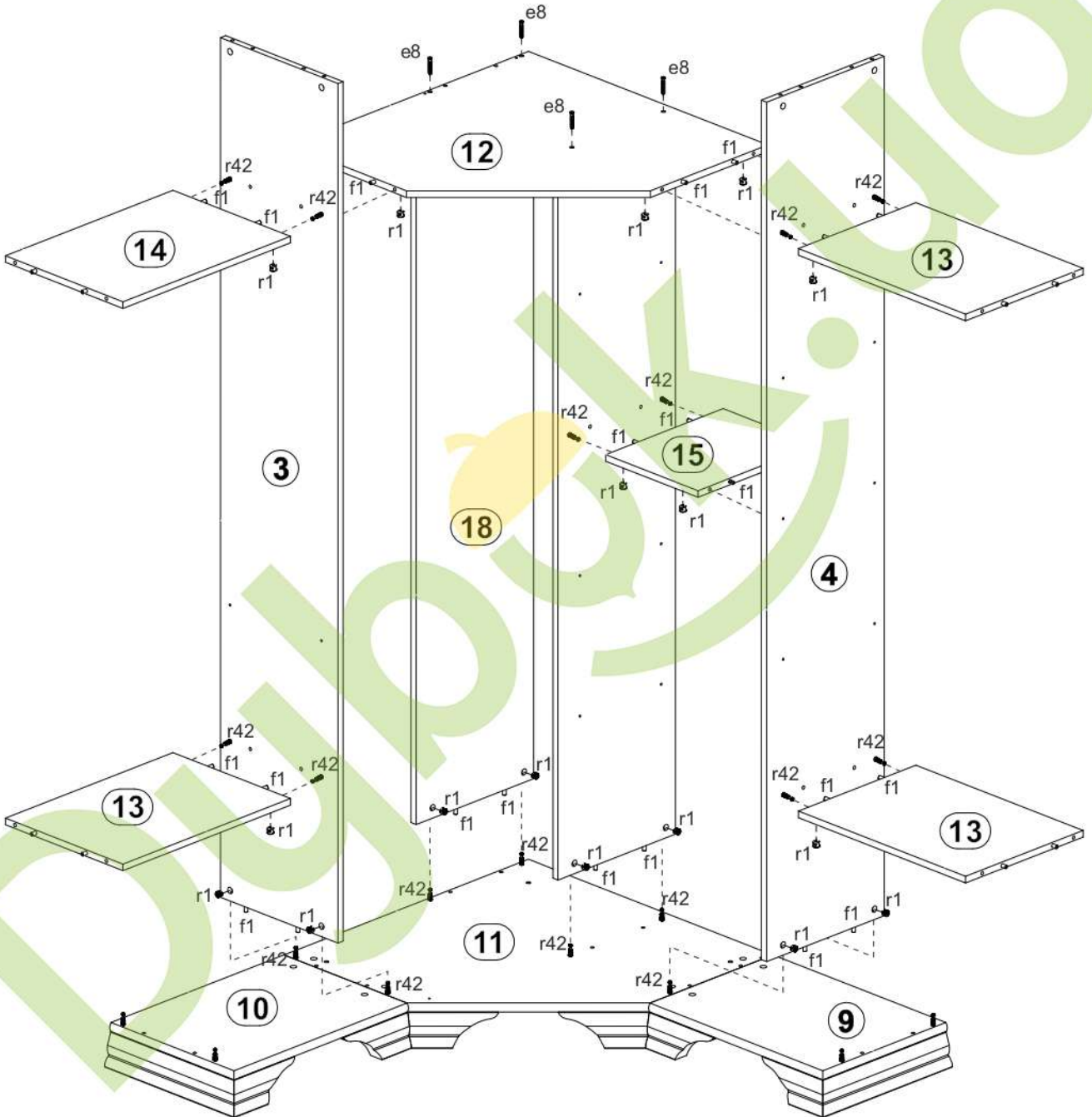
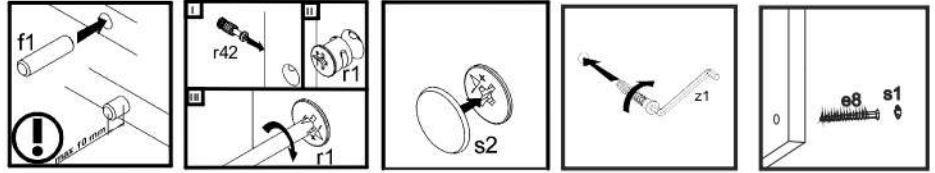

6

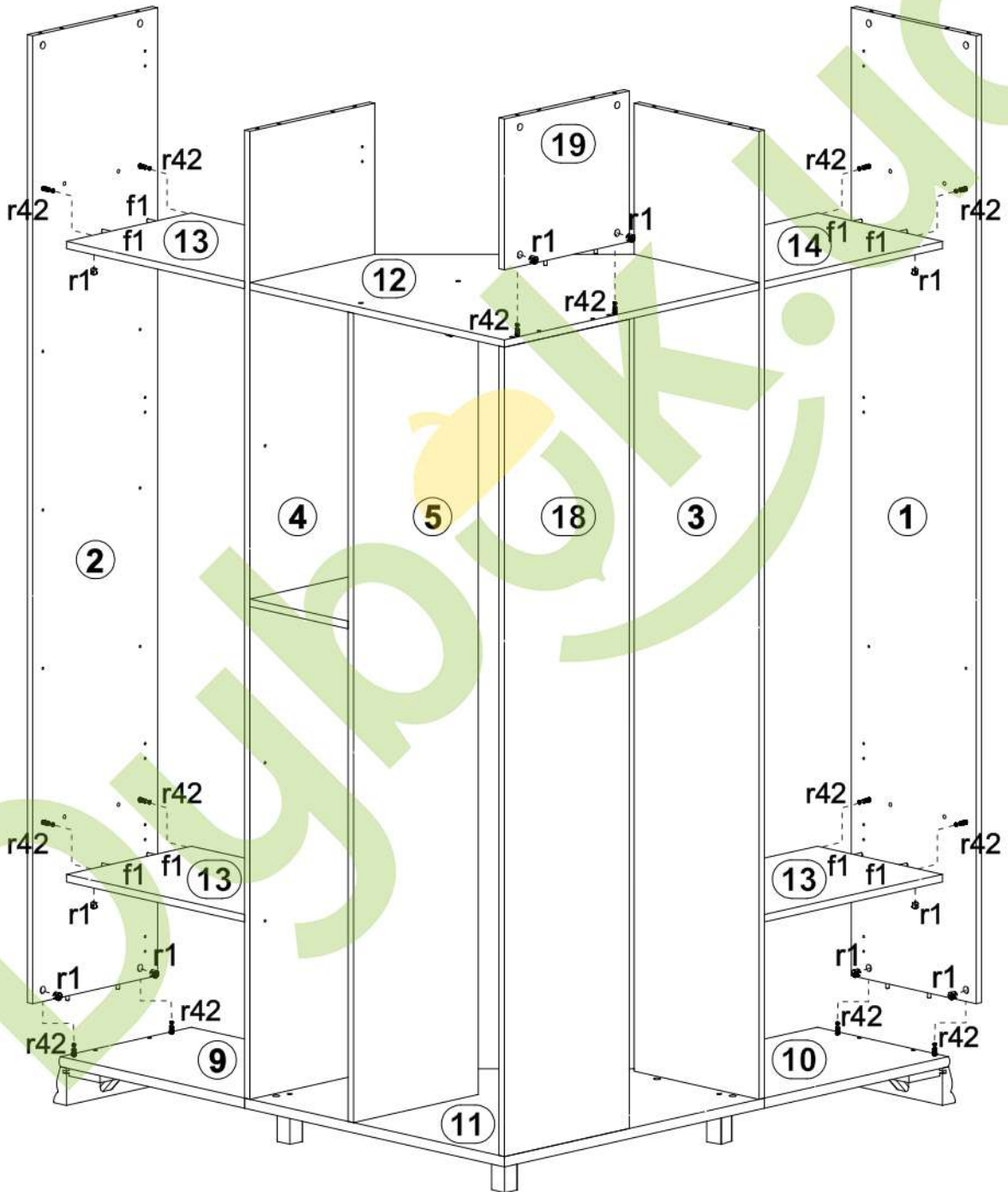
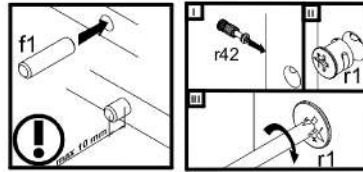

7

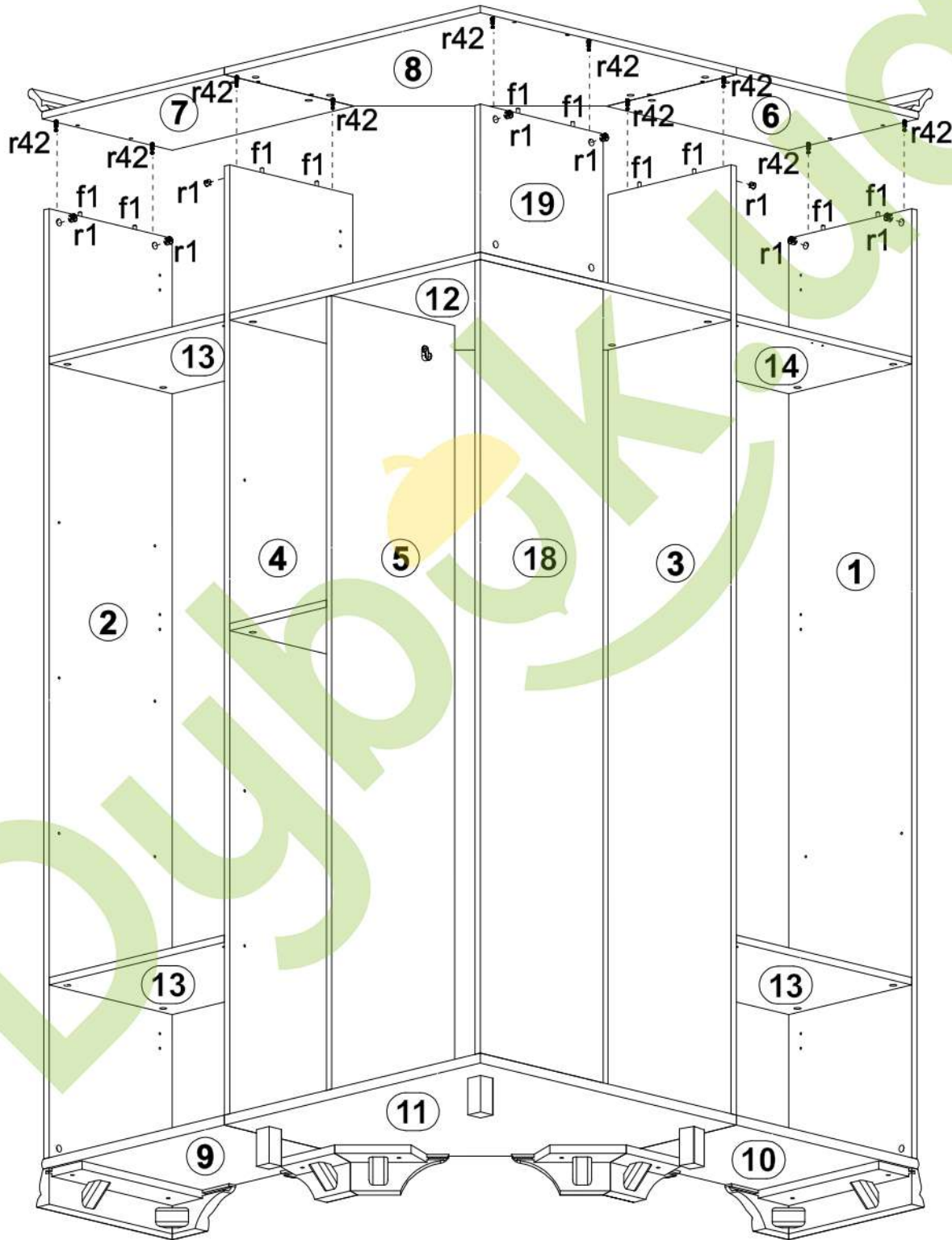
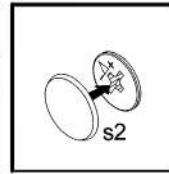
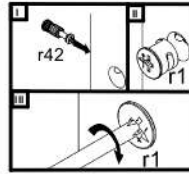
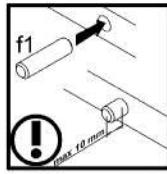

8

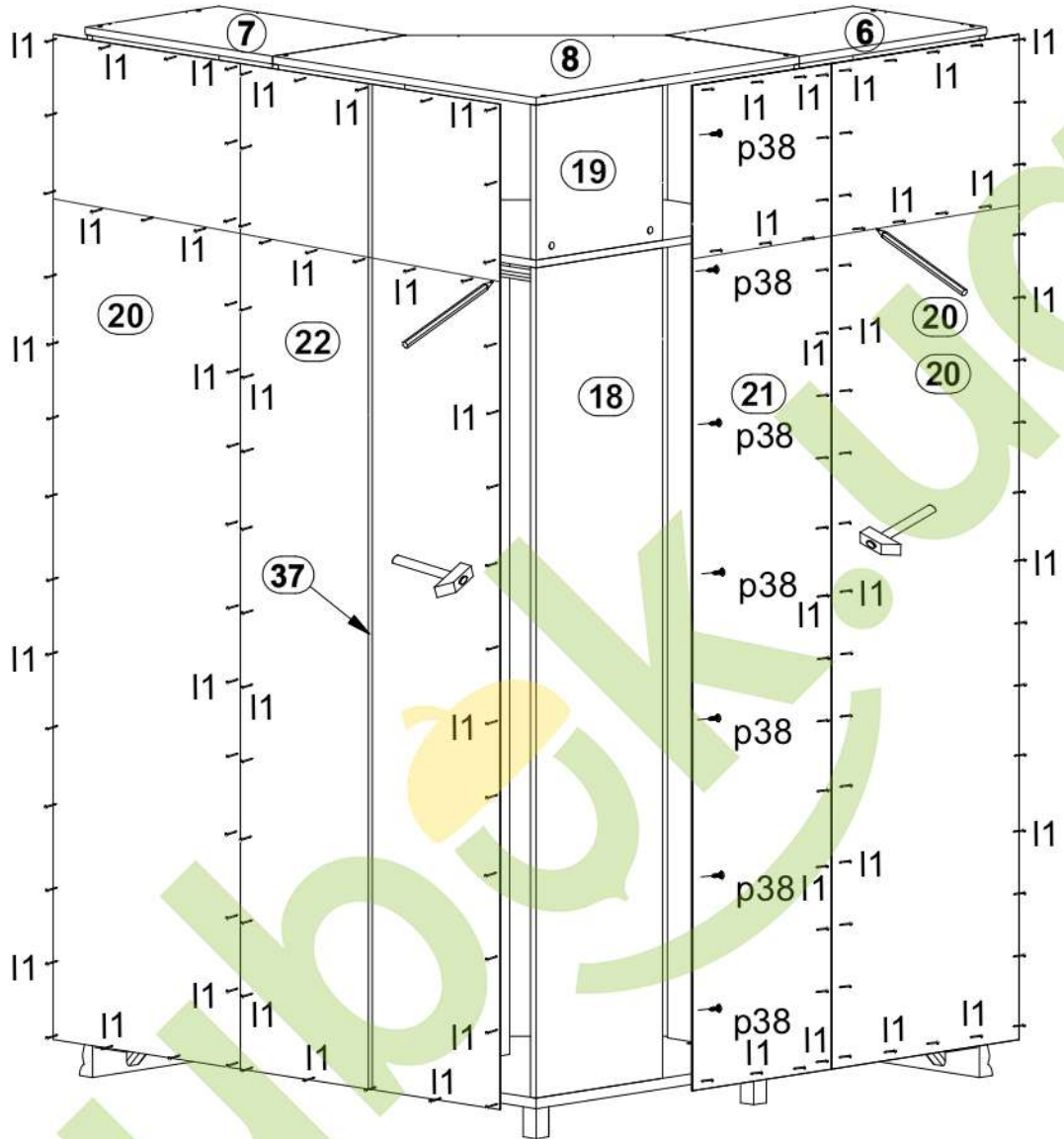
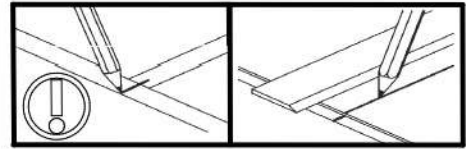
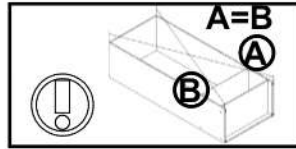

9

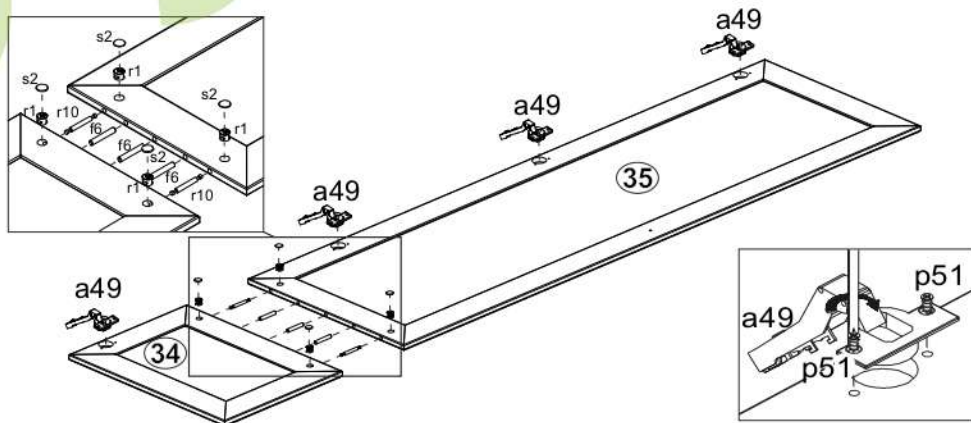

10

