

A	B	C	D	
1	S162-0006	494	176	3/3
2	S162-1101	885	371	1/3
3	S162-1102	885	371	1/3
4	S162-2203	522	397	1/3
5	S162-4404	488	60	1/3
6	S162-4405	488	60	1/3
7	S162-4408	488	60	1/3
8	S162-9904	461	355	1/3
9	S162-9907	850	256	1/3
10	ZS3-509	350	120	1/3
11	ZS3-510	350	120	1/3
12	ZS3-5506	439	120	1/3
15	Lh-820	820	14	1/3

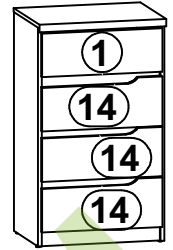

S162-KOM4SL

S162-KOM4SP

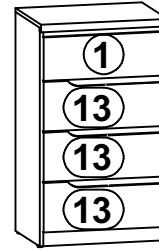

S162-KOM4SL

A	B	C	D	
13	S162-016	494	200	2/3

S162-KOM4SP

A	B	C	D	
14	S162-002	494	200	2/3

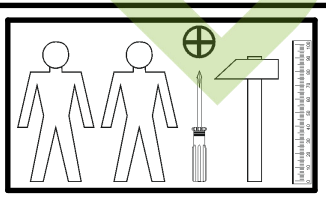
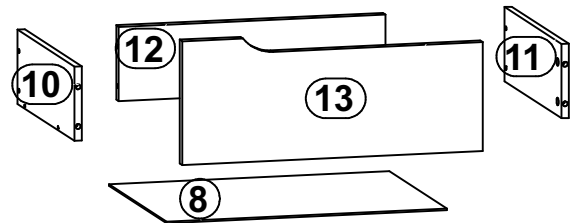
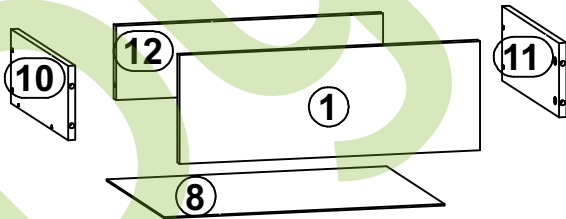
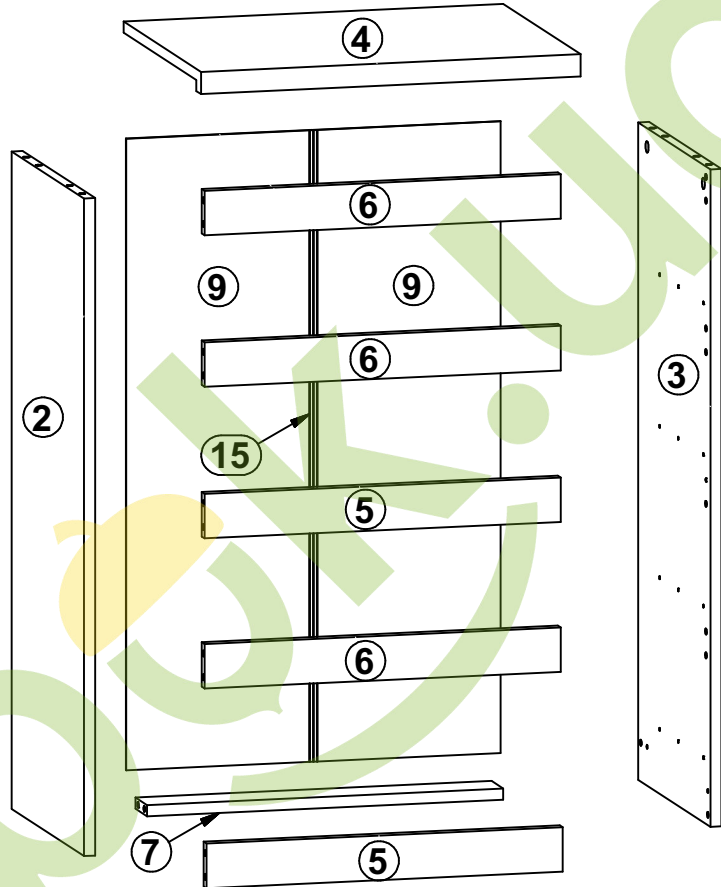

16x φ5x9 mm e19	24x φ6x13 mm e3	22x φ8x30 mm f1	16x φ6.5x40 mm f25	4x k1	30x l1	12x φ3.5x16 mm p38	10x φ1.5x12mm #16 r1	16x φ12x10.5mm #12 r15
26x r42	4x 350 mm w45ICL	4x 350 mm w45ICR	4x 350 mm w45IDL	4x 350 mm w45IDR	1x n2611	1x φ3.5x16 mm p38		

1

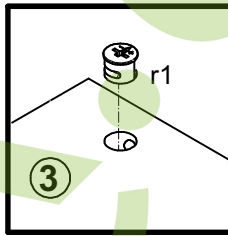
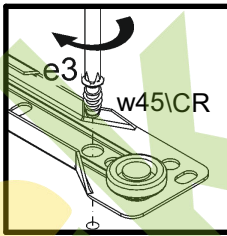
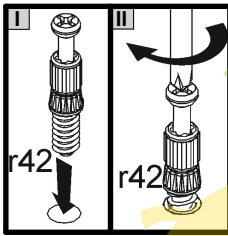
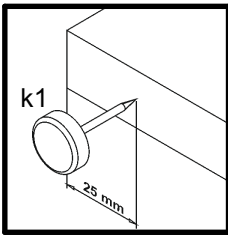
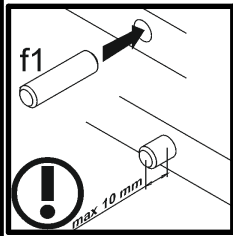
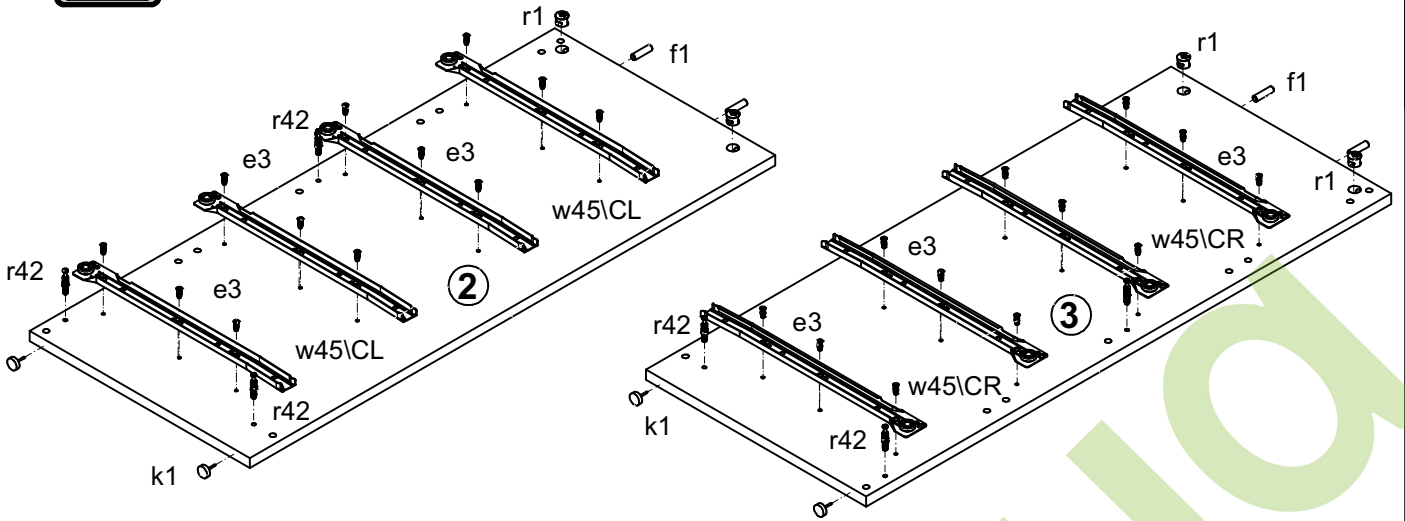

2

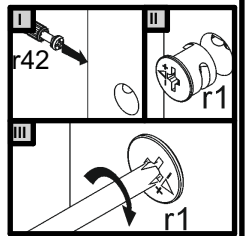
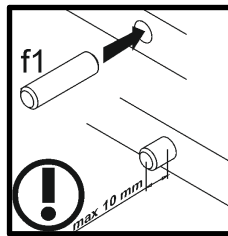
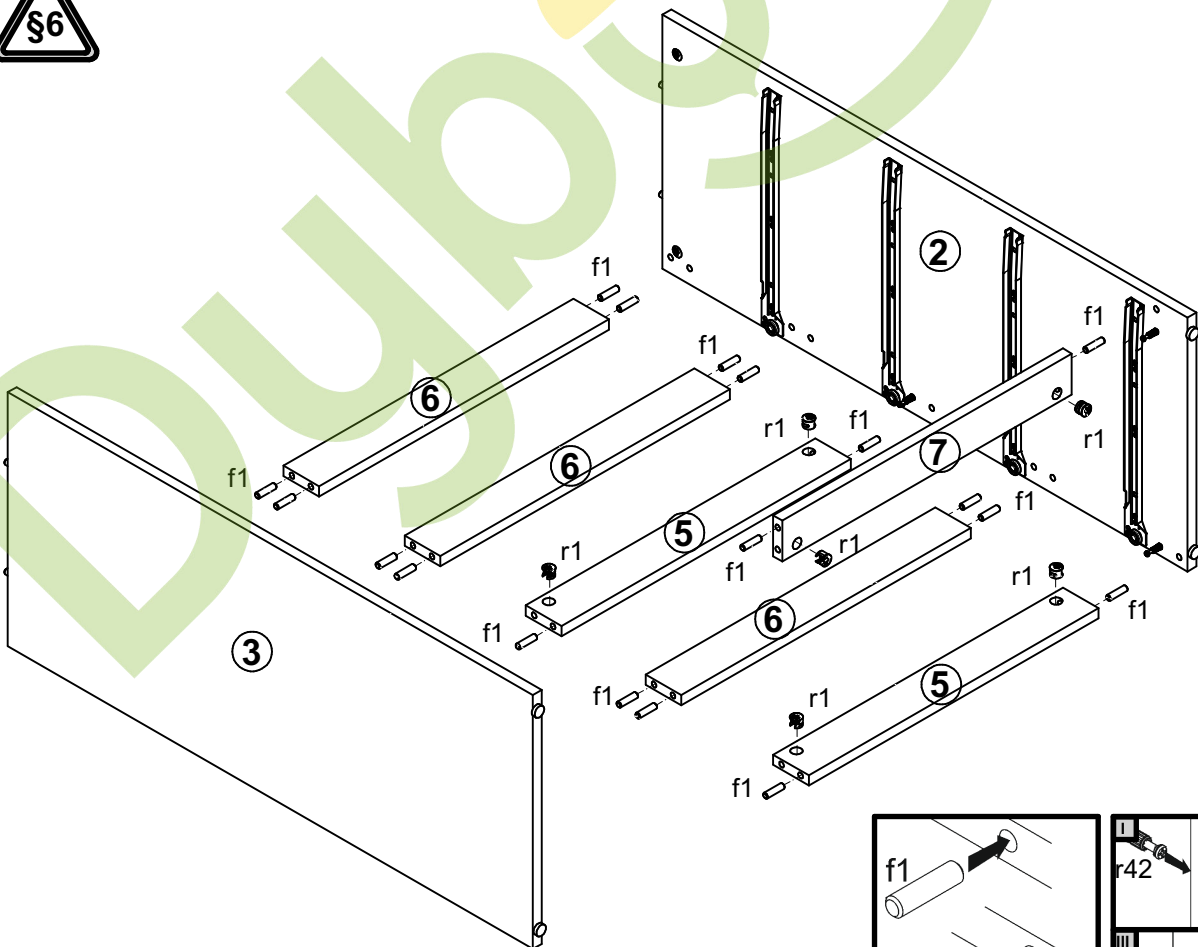

3

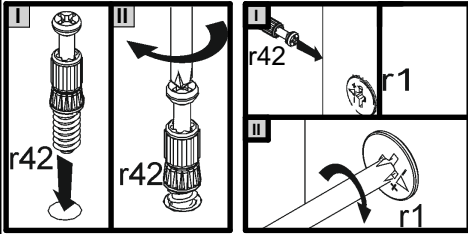
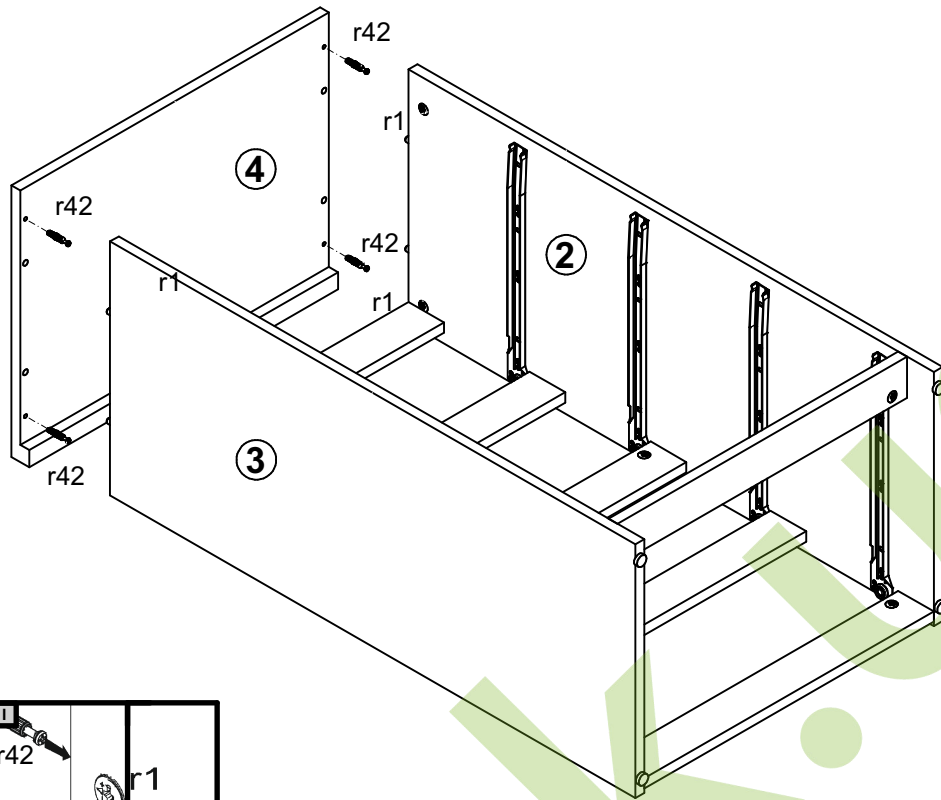

4

